

Lounge Lizard

USER MANUAL

A | A | S

Applied Acoustics Systems

Information in this manual is subject to change without notice and does not represent a commitment on the part of Applied Acoustics Systems DVM Inc. The software described in this manual is furnished under a license agreement. The software may be used only in accordance of the terms of this license agreement. It is against the law to copy this software on any medium except as specifically allowed in the license agreement. No part of this manual may be copied, photocopied, reproduced, translated, distributed or converted to any electronic or machine-readable form in whole or in part without prior written approval of Applied Acoustics Systems DVM Inc.

©2012 Applied Acoustics Systems DVM Inc. All rights reserved. Printed in Canada.

Program Copyright ©2002 Applied Acoustics Systems, Inc. All right reserved.

Lounge Lizard EP is a Trademark of Applied Acoustics Systems DVM Inc. Windows and Windows Vista are registered trademarks of Microsoft Corporation in the United States and other countries. Mac OS and Audio Units are registered trademarks of Apple Corporation. VST Instruments and ASIO are trademarks of Steinberg Soft Und Hardware GmbH. RTAS and AAX are registered trademarks of Avid Technology Inc. All other product and company names are either trademarks or registered trademarks of their respective owner. Unauthorized copying, renting or lending of the software is strictly prohibited.

Visit Applied Acoustics Systems DVM Inc. on the World Wide Web at

www.applied-acoustics.com

Contents

1	Introduction	6
1.1	System Requirements	6
1.2	Installation and Authorization	7
1.3	Getting Started	7
1.3.1	Using <i>Lounge Lizard EP</i> in Standalone Mode	7
1.3.2	Exploring the Factory Sounds	8
1.3.3	Using <i>Lounge Lizard EP</i> as a Plug-in	9
1.4	Getting Help	9
1.5	About this Manual	9
2	The Electric Piano	10
2.1	General Functioning	10
2.2	Tuning an Electric Piano	10
3	General organization of <i>Lounge Lizard EP</i>	12
3.1	The Play View	12
3.2	The Edit View	12
3.3	The FX view	14
4	Bank and Program Management	15
4.1	Banks and Programs	15
4.2	Saving Programs	15
4.3	The Bank Manager	15
4.4	Backups of Banks and Programs	17
4.5	Exchanging Banks and Programs	17
4.6	Restoring the Factory Library	18
5	Parameters	19
5.1	General Functioning of the Interface	19
5.1.1	Knobs	19
5.1.2	Switches	19
5.1.3	Drop-down Menus	19

5.1.4	Modulation Signals	19
5.1.5	Synchronisation	20
5.2	The Edit View	20
5.2.1	The Hammer Module	20
5.2.2	The Fork Module	22
5.2.3	The Pickup Module	23
5.2.4	The Damper Module	24
5.2.5	The Tremolo Module	25
5.3	The FX View	25
5.3.1	EQ	26
5.3.2	Compressor	27
5.3.3	Delay	29
5.3.4	Distortion	29
5.3.5	Chorus	30
5.3.6	Flanger	31
5.3.7	Phaser	34
5.3.8	Wah	35
5.3.9	Notch Filter	36
5.3.10	Reverb	37
5.4	The Play View	39
6	Utility Section	40
6.1	The MIDI LED	40
6.2	Polyphony	40
6.3	Tuning	41
6.4	History and Compare	41
6.5	Volume	42
6.6	Level Meter	42
6.7	The About Box	42

7	Audio and MIDI Settings	43
7.1	Audio Configuration	43
7.1.1	Selecting an Audio Device	43
7.1.2	Latency	43
7.2	MIDI Configuration	44
7.2.1	Selecting a MIDI Device	44
7.2.2	Creating MIDI Links	44
7.2.3	Creating a default MIDI Map	44
7.2.4	MIDI Program Changes	45
7.2.5	MIDI Bank Changes	45
7.2.6	Pitch bend	45
7.2.7	Modulation wheel	45
8	Using <i>Lounge Lizard EP</i> as a Plug-In	46
8.1	Audio and MIDI Configuration	46
8.2	Automation	46
8.3	Multiple Instances	46
8.4	MIDI Program Change	46
8.5	Saving Projects	46
8.6	Performance	47
9	License Agreement	48

1 Introduction

The *Lounge Lizard EP* is a software electric piano based on the classic instruments of the seventies. Each component of these instruments has been modeled with AAS cutting edge physical modeling technology to provide realistic and lively sounds. Physical modeling uses the laws of physics to reproduce the behavior of an object. In other words, the *Lounge Lizard EP* solves, in real time, mathematical equations describing how its different components function. No sampling or wavetables are used in the *Lounge Lizard EP*, the sound is simply calculated in real time by the CPU according to the values each parameter is receiving. The *Lounge Lizard EP* is more than a simple recreation of vintage instruments, its parameters can be tweaked to values not possible with the real instruments to get some truly amazing new sounds that still retain a warm acoustic quality.

Before discussing the synthesizer in more detail, we would like to take this opportunity to thank you for choosing an AAS product. We sincerely hope that this product will bring you inspiration, pleasure and fulfill your creative needs.

1.1 System Requirements

The following minimum computer configuration is necessary to run *Lounge Lizard EP*:

Mac OS

- Mac OS X 10.7 or later
- Intel Core processor or later
- 512 MB of RAM
- 70 MB of free hard drive space
- 1024 x 768 screen resolution
- Built-in audio interface

Windows

- Windows 7 or later 32-bit/64-bit
- Intel Core or equivalent processor
- 512 MB of RAM
- 70 MB of free hard drive space
- 1024 x 768 screen resolution

- Windows-compatible audio interface
- Windows-compatible MIDI interface/keyboard

Keep in mind that the computational power required by *Lounge Lizard EP* depends on the number of voices of polyphony and the sampling rate used. These computer configurations will enable you to play the factory sounds with a reasonable number of voices but performances will vary depending on your specific computer configuration.

1.2 Installation and Authorization

Installation and authorization of *Lounge Lizard EP* is quick and easy. For the installation of our different products we use so-called *custom installers* which include both the program itself and your licence information. Installation and authorization can therefore be carried out automatically in a single step and from a single file when your computer is online. AAS products use a copy protection system based on a proprietary challenge/response key exchange and therefore their authorization does not rely on other third party software and/or hardware.

In order to start the installation process, simply double-click on the installer file that you have downloaded. This will first install the program and then use the licence information included in the custom installer file to carry out automatically the challenge/response procedure.

Once the installation is completed, you can check your licence information by starting the program and clicking on the chevron icon at the top of the interface. This will open a dialog box in which you should see your serial number and the email address which you used in order to get the installer file. Note that your serial number is also sent to you by email when your custom installer is created.

If your computer is offline when running the installer, or if the authorization procedure could not be completed for another reason, the dialog box will not show your serial number and you will be prompted to authorize the program. In that case, click on the *Authorize* button and follow the on-screen instructions. Note that it is possible to use the program during 15 days before completing the authorization process. After that period, the program will not function unless it is authorized.

1.3 Getting Started

1.3.1 Using *Lounge Lizard EP* in Standalone Mode

Lounge Lizard EP comes with a standalone versions allowing you to play it without having to open your sequencer. This can be convenient to explore *Lounge Lizard EP* and its library, play it live or do some sound design work. To start *Lounge Lizard EP* in standalone mode, simply follow the instructions below:

- **Windows** - Double-click on the *Lounge Lizard EP* icon located on your desktop or select *Lounge Lizard EP* from the **Start > All Programs >** menu.
- **Mac OS** - Double-click on the *Lounge Lizard EP* icon located in the Applications folder.

Before you start exploring the program, take a moment to set up you audio and MIDI configuration as explained below.

Audio and MIDI Configuration

Audio and MIDI configuration tools are available by clicking on the **Audio Setup** button located in the lower left corner of the *Lounge Lizard EP* interface. The **Audio Setup** dialog first allows you to select an audio output device from those available on your computer. Multi-channel interfaces will have their outputs listed as stereo pairs.

On Windows, the audio output list is organized by driver type. The device type is first selected from the *Audio Device Type* drop-down list. If you have ASIO drivers available, these should be selected for optimum performance. The **Configure Audio Device button** allows you to open the manufacturer's setup program for your audio interface when available.

Once the audio input has been selected, you can then select a sampling rate and a buffer size from those offered by your audio interface.

The list of available MIDI inputs appears at the bottom of the dialog. Click on the checkbox corresponding to any of the inputs you wish to use.

1.3.2 Exploring the Factory Sounds

Lounge Lizard EP comes with a wide range of factory programs right out of the box which amounts to a huge range of sounds before you have even turned a single knob. As you would expect, the best way of coming to grips with the possibilities *Lounge Lizard EP* offers is simply to go through the programs one at a time.

Lounge Lizard EP uses the notions of *Banks* and *Programs* to organize and classify sounds. A program or preset is a stored set of parameters corresponding to a given sound. The programs are grouped and organized in banks.

The name of the currently loaded bank and program are displayed at the top of the interface. One navigates among the different banks and programs by using the arrows in each of the corresponding boxes or by opening the associated drop-down menu by clicking inside these boxes. Banks and programs are managed using the *Bank Manager* which is revealed by clicking on the *Manage* button appearing above the right-top corner of the *Bank* box. Playing programs and organizing them is pretty straightforward, please refer to Chapter 4 for a complete description of the bank and program management operations.

1.3.3 Using *Lounge Lizard EP* as a Plug-in

Lounge Lizard EP integrates seamlessly into the industry's most popular multi-track recording and sequencing environments as a virtual instrument plug-in. *Lounge Lizard EP* works as any other plug-in in these environments so we recommend that you refer to your sequencer documentation in case you have problems running *Lounge Lizard EP* as a plug-in. Note that in plug-in mode the audio and MIDI inputs, sampling rate, and buffer size are determined by the host sequencer.

1.4 Getting Help

AAS technical support representatives are on hand from Monday to Friday, 9am to 6pm EST. Whether you have a question on *Lounge Lizard EP*, or need a hand getting it up and running as a plug-in in your favorite sequencer, we are here to help. Contact us by phone or email at:

- North America Toll Free: 1-888-441-8277
- Worldwide: 1-514-871-8100
- Email: support@applied-acoustics.com

Our online support pages contain downloads of the most recent product updates, and answers to frequently asked questions on all AAS products. The support pages are located at:

1.5 About this Manual

Throughout this manual, the following conventions are used:

- Bold characters are used to name modules, commands and menu names.
- Italic characters are used to name controls on the interface.
- Windows and Mac OS keyboard shortcuts are written as Windows shortcut/Mac OS shortcut.

2 The Electric Piano

2.1 General Functioning

The mechanism of an electric piano is relatively simple and is illustrated in Figure 1. A note played on the keyboard releases a damper and activates a felt-tipped hammer which hits a metal bar having the shape of a tuning fork. The struck portion of the fork is called the tine and is made of stiff steel wire. The other part of the fork, parallel to the tine, is called the tonebar. It acts as a resonator adding sustain to the sound. The vibrations of the tine bar are picked up by an electromagnetic pickup and sent to an amplifier, very much like in an electric guitar. The result is a very expressive instrument with a characteristic smooth tone which can also be made to growl or bark when played harder and the pickups introduce nonlinear distortion.

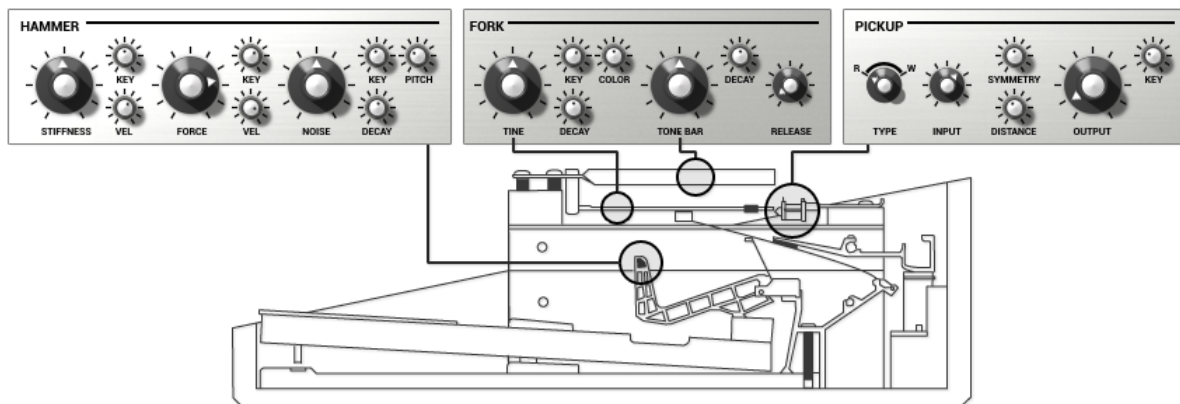

Figure 1: Geometry of an electric piano and corresponding elements on the *Lounge Lizard EP* interface.

The functioning of a reed electric piano is very similar except that instead of a fork, the hammer hits a metal reed as shown in Figure 2. The reeds are placed near metal plates which together with the metal reeds form an electrostatic or capacitive pickup system. Compared to electric pianos based on metal fork, these instruments are known to have a brighter and more hollow sound.

2.2 Tuning an Electric Piano

Electric pianos provided adjustment for pitch, timbre, and volume. On the original pianos, the tine is fitted with a spring which can be moved along its length for fine-tuning. The tone and volume can also be adjusted by changing the position of the tine in relation to the pickups. Tuning a reed piano is even more delicate. On the tip of each reed is a lump of solder whose size and shape alter both the pitch and the tone of the note. These adjustments were at the heart of the electric piano character as they control the harmonic content, attack, and decay of the sound, offering unique

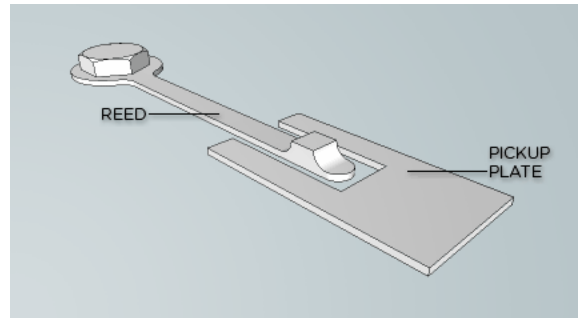

Figure 2: Reed and electrostatic pickup.

tone to each player. But there was a price for this flexibility, several painstaking hours with a screwdriver or soldering iron and incredible patience was needed to change the sound of an electric piano. Suffer no more with Lounge Lizard, the preset library provides a selection of thoroughly chosen configurations reproducing popular models so that you do not have to touch one knob before starting to play. The flexibility of the engine gives you access to all the physical parameters of the instrument allowing you to fine-tune every preset to your playing style.

3 General organization of *Lounge Lizard EP*

Lounge Lizard EP is a complete electric piano solution including complete modeling of the different electro-mechanical elements of a piano, a vast library of sounds and a multi-effects module. The graphical interface of *Lounge Lizard EP* has been organized around three different views as shown in Figures 3, 4 and 5.

The first view, called the *Play* view of the instrument, gives access to the main parameters of the piano and effect modules and should be sufficient for most playing situations. The second and third views, called the *Edit* and *FX* views respectively, allows for in-depth editing of the different piano and effect parameters and are used for sound design purposes.

One can switch from one view to the other by using the *Play*, *Edit* and *FX* buttons located in the *utility* section at the top of the interface. This section of the interface is common to all the views and includes the bank manager, used to access and manage sounds, as well as general settings and indicators. These tools are described in details in Chapter 4 and Chapter 6 respectively.

The size of the graphical interface can be adjusted by click-dragging the handle in its lower right corner. While resizing the interface the zoom factor is displayed in the upper left corner of the interface. This zoom factor can always be displayed by positioning the mouse on this corner. When clicking on the zoom factor, a drop-down menu with specific size ratios is displayed. Selecting a value resizes the interface automatically to that ratio. Note that this resize feature is only available for 64-bit versions of the program.

3.1 The Play View

The lower section of this view is where the main piano parameters are displayed. On the left of these parameters, one finds a pitch bend wheel and a modulation wheel controlling the *depth* of the **Tremolo** module. Just below is a clickable eight octave ribbon allowing one to play different notes on the range of the piano which can be useful when no MIDI keyboard is connected to the computer.

The middle section of this view allows one to turn the effects from the multi-effects module *on* and *off* and to rapidly adjust their main parameters.

3.2 The Edit View

The *Edit* view gives access to all the piano parameters. The different parameters have been grouped into five modules corresponding to the main components of an electric piano: the **Hammer**, **Fork**, **Pick-up**, **Damplifier** and **Tremolo**. These will be reviewed in detail in Chapter 5.



Figure 3: The Play view.



Figure 4: The Edit view.

3.3 The FX view

The *FX* view includes an **EQ**, a **Compressor**, a **Multi-Effects**, and a **Reverb** module. The **Multi-Effects** module consists in two effects in series. The effect list includes a **Delay**, **Distortion**, **Chorus**, **Flanger**, **Phaser**, **Wah Wah**, **Auto Wah** and a **Notch** filter. The functioning of the effect modules is described in details in Chapter 5.



Figure 5: The FX view.

4 Bank and Program Management

Lounge Lizard EP comes with several factory presets, called *programs*, covering a wide range of effects. This collection of programs lets you play and familiarize yourself with this synthesizer without having to tweak a single knob. Soon, however, you will be experimenting and creating your own sounds and projects that you will need to archive or exchange with other users. In this section, we review the management of programs.

4.1 Banks and Programs

Presets are stored in banks containing so-called *programs*. The name of the currently selected bank is shown in the *Bank* drop-down display located in the top of the *Lounge Lizard EP* interface. The list of available banks is viewed by clicking on the *Bank* display. A bank can be selected by navigating in the list of banks using the left and right-pointing arrows in the display or by clicking on its name when the list of banks is open. Clicking on the bank display brings focus on this section of the interface, the display is then outlined by an orange line, and one can then navigate through the list of banks using the up, down, left, or right arrows of the computer keyboard.

The list of programs included in the currently selected bank can be viewed by clicking on the *Program* display located below the *Bank* display. A program is selected by using the left and right-pointing arrows or by clicking directly on its name. Once a program is selected, the value of the different parameters of the synthesizer are updated and it can then be played. As for the bank list, one can navigate through the program list using the computer arrows after clicking on the *Program* display.

4.2 Saving Programs

Programs are saved by clicking on the *Save* button located to the right of the *Program* display. When a program has just been loaded, this command is greyed and therefore inactive. It is activated as soon as a parameter of the interface is modified. Clicking on this command replaces the stored version of the program with the new one.

The *Save As* command is activated by clicking on the corresponding button which opens the **Save Program** pop-up window. It is then possible to save the program under a new name or its current one in any of the available program banks. Note that if the original name of the program is used, a new program with the same name will be created at the end of the program list meaning that the original program is not erased. This also implies that it is possible to have many programs with the same name in the same bank.

4.3 The Bank Manager

Banks and Programs can be organised using the **Bank Manager**. The manager window is displayed by clicking on the *Manager* button located to the right of the *Bank* and *Program* display. It is closed

by clicking again on the same button. On the left of the window, one finds the list of banks. Clicking on a bank name fills the list of programs located in the center of the window with the name of these included in the selected bank.

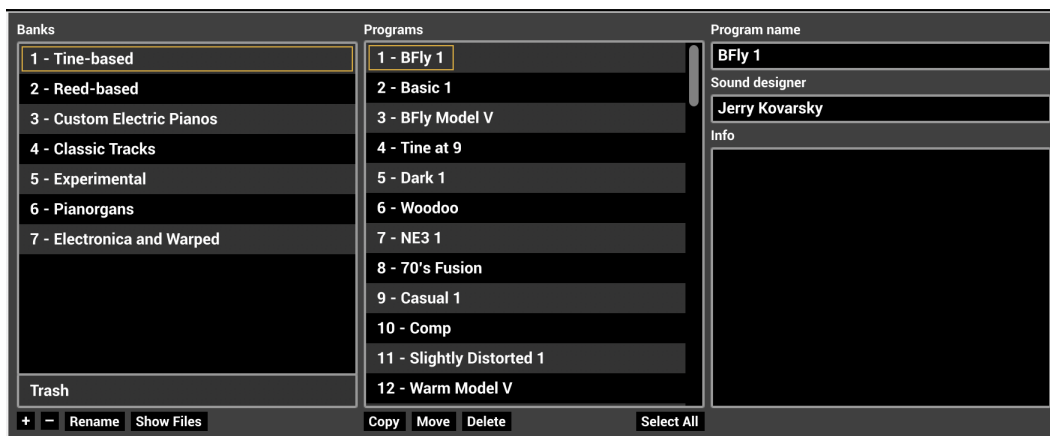

Figure 6: Bank and program manager window.

A new bank can be created by clicking on the + button below the bank list. This opens the **Create New Bank** window in which the name of the new bank can be entered. A bank can be deleted by first selecting it in the bank list and then clicking on the - button. Be careful, this command erases a bank and all the programs it contains; this operation is permanent and can not be undone. In order to rename a bank, simply click on the *Rename* button and enter a new name.

Banks and the information corresponding to each of its programs is stored in a simple text file on your computer hard disk. In order to view these bank files, click on the *Show Files* button under the bank list. On Windows, this command will open an Explorer window at the location where the files are stored. On Mac OSX, the command has a similar effect and opens a Finder window. All the bank file names follow the same format and begin with the bank name. These files can be used for backups or to exchange presets with other users.

The list of programs included in the selected bank is displayed in the program list in the center of the manager window. Presets are selected by clicking on their name which updates the program information appearing on the right of the preset list. Program information includes the name of the preset, its author and comments. This information can be updated by clicking on the corresponding box which opens an edition window. Note that multiple presets can be updated simultaneously by selecting more than one preset at once and clicking on a preset information box.

A multiple selection consisting of adjacent programs is obtained by holding down the *Shift* key on the computer keyboard and then clicking on the name of the first program to be copied and then the last one. A non-adjacent multiple selection is obtained by holding down the *Ctrl/command* computer key and clicking on the name of the different programs to be copied. It is also possible to select all programs at once by clicking on the *Select All* button at the bottom of the program list.

Programs can be copied to another bank by clicking on the *Copy* button. A program must first

be selected by clicking on its name on the program list; it is then copied by moving the mouse to a given bank in the *Bank* list on the right and clicking on the bank name. The **Move** command is activated by clicking on the *Move* button; it copies a preset to a new bank but also erases it in the original bank. A multiple selection of programs can be used with the **Copy** and **Move** commands

Programs can be deleted from a bank by first selecting them and then clicking on the *Delete* button. This will move the programs to a special bank called *Trash* which is located below the regular list of banks. This means that deleted programs can always be recuperated as long as they are not deleted from the *Trash* bank. The content of the *Trash* bank is viewed by clicking on its name; the different programs can then be moved to the other banks as explained above. The *Trash* bank can be emptied by clicking on the *Empty Trash* button which appears below the program list when the *Trash* bank is selected. Be careful as this command can not be undone.

4.4 Backups of Banks and Programs

User banks are stored on disk as simple text files located in the following folders:

On **Mac OS**:

/Users/[user name]/Library/Application Support/Applied Acoustics Systems/Lounge Lizard EP-4/Banks

On **Windows**:

%AppData%\Applied Acoustics Systems\Lounge Lizard EP-4\Banks

The bank files saved by *Lounge Lizard EP* are named using the following convention:

[name of bank].EP-4 Bank

These files contain all the information corresponding to the programs they include. These files can be displayed directly from *Lounge Lizard EP* by opening the *Bank* manager and clicking on the *Show Files* button. This will open an Explorer or Finder window on Windows or Mac OS respectively at the right location.

The simplest way to create a backup of banks and programs is to make a copy on an external media of the above mentioned folders. Individual banks can be backed-up by making copies of individual bank files.

4.5 Exchanging Banks and Programs

Banks and programs can easily be shared with other *Lounge Lizard EP* users. This operation simply involves the exchange of the above mentioned user bank files. When a new bank file is copied to the bank folder, it is automatically available to *Lounge Lizard EP*.

Note that individual programs can not be exported. They always appear inside a bank file. If you only wish to share a few programs, create a new bank, copy the programs you wish to exchange to this bank and share the corresponding bank file.

4.6 Restoring the Factory Library

If necessary, it is possible to restore the original factory library of banks and programs. The original factory bank files are located in the following folders:

On **Windows 64-bit**:

C:\Program Files (x86)\Applied Acoustics Systems\Lounge Lizard EP-4\Factory Library

On **Windows 32-bit**:

C:\Program Files\Applied Acoustics Systems\Lounge Lizard EP-4\Factory Library

On **Mac OS** startup disk:

/Library/Application Support/Applied Acoustics Systems/Lounge Lizard EP-4/Factory Library

Restoring the factory library simply involves copying the files contained in these folders and pasting them in the user bank folders listed in Section 4.4. The user bank folders can be opened directly in an Explorer or Finder window, on Windows and Mac OS respectively, or by using the *Show Files* command directly from the *Lounge Lizard EP* bank manager.

Note that if you have bank files with the original factory bank names in your user bank folder, they will be replaced by the original factory files. This means that you will lose programs that you would have modified or created in these banks. This operation must therefore be done with caution and it is recommended that you make copies or rename your user banks before proceeding with the restore.

5 Parameters

This section can be used as a reference on the different controls appearing on the *Lounge Lizard EP* graphical interface. We begin by describing the behavior of the different types of controls appearing on the interface and then describe the parameters of each module of the synthesizer. These parameters are accessible from the *Edit* and *FX* views of the synthesizer. In addition, some of them are also available directly from the *Play* view as will be indicated.

5.1 General Functioning of the Interface

5.1.1 Knobs

The synthesizer parameters are adjusted using controls such as knobs, switches and numerical displays. A specific control is selected by clicking on it. A coarse adjustment is obtained by click-holding the parameter and moving the mouse (or the finger on a track pad) either upwards and downwards or leftwards and rightwards. The value of the parameter replaces its label while it is being adjusted.

Fine adjustment of a control is obtained by holding down a modifier key of the computer keyboard (Shift, Ctrl, Command or Alt key) while adjusting the parameter. Precise values can also be entered manually by clicking on the parameter label and typing the value on the computer keyboard.

Double clicking on a knob brings it back to its default value when available.

5.1.2 Switches

Switches are turned *on* or *off* by clicking on them. They are used to activate or deactivate modules and the *sync* feature of some parameters.

5.1.3 Drop-down Menus

Clicking on a display with a small down-pointing triangle reveals a drop-down menu with a set of possible settings for the control. Adjustment of the control is obtained by clicking on a selection.

5.1.4 Modulation Signals

Different parameters can be modulated with the note and velocity signals from the **Keyboard**. Modulation signals are controlled with the small knobs labeled *Key* or *Vel* located on the right of the corresponding control knobs in the different modules of the instrument.

The *Key* modulation knobs are used to modulate a parameter depending on the note played on the keyboard. When in its center position, the value of the corresponding parameter is equal across

the whole range of the keyboard. Turning the knob to the left increases the value of the parameter for low notes while decreasing its value for high notes. The variations are applied relative to the middle C (C3) whose value is always that corresponding to the settings of the actual parameter knob. Turning the modulation knob to the right has the opposite effect and increases the value of the parameter for high notes while decreasing it for low notes.

The *Vel* modulation knobs are used to modulate the value of a parameter depending on the velocity signal received from the keyboard so that the value of a parameter will increase as notes are played harder on the keyboard. The position of the knob is used to adjust the amount of modulation applied to the parameter. In its leftmost position, the modulation source is turned off and the value of the parameter will not vary with the velocity signal from the keyboard. Turning the knob clockwise will increase the effect of the modulation signal on the value of the parameter.

5.1.5 Synchronisation

The rate of the **Tremolo** module and certain effects can be synchronized to the clock of the host sequencer. To do so, simply turn *on* the *Sync* switch. Sync values are adjusted with the *Rate* knob and range from 16 quarter notes (4 whole notes) to 1/8 of a quarter note (a thirty-second note) where the duration of the whole note is determined by the host sequencer clock. The effect can also be synced to a triplet (t) or dotted note (d).

5.2 The Edit View

The **Edit** view is activated by clicking on the *Edit* button in the top part of the interface. It allows one to go 'under the hood' and adjust the different piano parameters and therefore to customize its tone and behavior. On vintage instruments voicing was done with a screwdriver and a lot of patience. You can now do this with just a few clicks.

5.2.1 The Hammer Module

The **Hammer** module is used to simulate the force impact produced by the piano hammer when striking the fork of the piano. It has three main parameters, **Stiffness**, **Noise** and **Force**.

Stiffness

The *Stiffness* knob determines if the hammer is soft or hard which is related to its material. As this knob is turned clockwise, the hammer gets harder. Figure 7 shows the effect of the adjustment of the stiffness on the output signal from

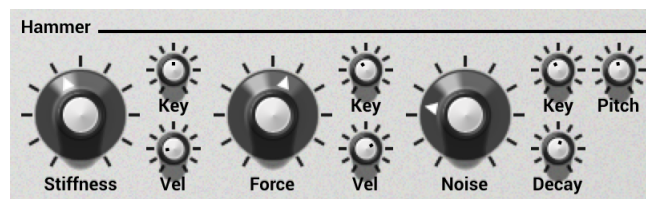

this module. As the stiffness is increased the excitation signal becomes narrower which reduces the interaction time between the hammer and the fork. This can be understood by the fact that the harder is the hammer, the more rapidly it will bounce following the impact with the fork thereby limiting the interaction time. A softer hammer (knob turned to the left) produces a more mellow tone while a harder one produces a brighter sound.

The *Key* modulation knob controls how the stiffness of the hammer is related to the pitch of the notes played on the keyboard. When this knob is turned to the right, the hammer will become stiffer as the notes played on the keyboard get higher. This is a behavior found on acoustic instruments like pianos and hammer driven instruments.

Likewise, the *Vel* knob controls how the stiffness of the hammer varies with the velocity signal from the keyboard. Turning this knob clockwise causes the hammer to become softer as one plays harder on the keyboard and stiffer as one plays more softly. Again, this is a behavior found on acoustic instruments.

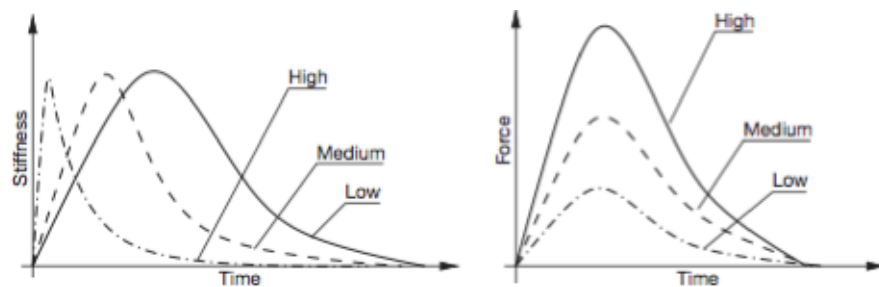

Figure 7: Effect of the *Stiffness* and *Force* knob on the output from the **Hammer** module.

Force

The *Force* knob is used to adjust the amplitude of the impact of the hammer on the fork as illustrated in Figure 7. When in its leftmost position, the impact is very soft and as the knob is turned clockwise, the impact gets stronger. The strength of the impact can be modulated both with the pitch of the note played and the velocity signal from the keyboard using the *Key* and *Vel* modulation knobs respectively. For example, the strength of the impact of the hammer could be made higher for high notes than low notes by turning the *Key* modulation knob to the right. It could also be adjusted to follow the velocity signal from the keyboard by turning the *Vel* knob clockwise.

Noise

The **Noise** knob is used to control the amount of noise generated during the impact between the hammer and the fork. Turning the knob clockwise increases the amplitude of the noise. The *Pitch* knob is used to determine the center frequency of the noise. Turning this knob clockwise increases the center frequency of the spectrum of the noise signal. The *Decay* knob is used to adjust the time

taken by the noise signal to fade out. As the knob is turned clockwise, the decay time increases. For a more natural sound, a shorter decay is preferable.

The *Key* knob is used to modulate the amount of noise depending on the pitch of the notes played on the keyboard. In its center position, the amount of noise is the same for all notes and equal to the value set by the *Noise* knob. When turned to the left, there is more noise for low notes than high notes. Turning the knob to the right has the opposite effect and the noise component is higher for high notes than low notes. Note that the *Noise* parameter can be adjusted directly from the **Play** view.

5.2.2 The Fork Module

The **Fork** module is at the heart of the sound generation mechanisms of the *Lounge Lizard EP*. The fork is the component that produces sound after being excited by the hammer. It has roughly the shape of a tuning fork with a small branch called the **Tine** and a larger one the **Tone bar**.

The Tine Bar

The tine is where the hammer hits the fork. It produces a high metallic sound very important for clear electric piano sounds.

The amplitude of the tine signal present in the final sound from the fork is controlled with the help of the *Tine* knob. Turning the knob clockwise increases the presence of the tine in the final sound. The amplitude of the tine signal can be modulated with the pitch of the note played using the *Key* knob. Turning this knob to the left will increase the presence of the tine in low notes while decreasing it for high notes. Turning this knob to the right has the opposite effect and increases the presence of the tine in high notes while decreasing it in low notes. In its center position the volume of the tine is uniform across the whole range of the keyboard.

The timbre of the tine bar can be adjusted with the *Color* knob which controls the relative amplitude of low and high partials in the spectrum of the sound produced by the tine bar. Turning this knob to the left will favor lower harmonics while turning it to the right will increase the relative amplitude of the high harmonics present in the spectrum.

The *Decay* knob is used to adjust the time taken by the tine to fade out when a key is depressed on the keyboard and a note is held. Turning this knob clockwise increases the natural decay time of the oscillations.



The Tone Bar

The tone bar is the biggest part of the fork, it is connected to the tine and starts to oscillate when the hammer hits the tine. The *Tone* knob is used to control the amplitude of the signal from the

tone bar present in the final sound. Turning this knob clockwise results in a louder sound from the tone bar. The *Decay* knob controls the time necessary for the oscillations of the tone bar to fade out when a key is depressed and a note is held. Turning this knob clockwise increases the decay time.

Note that the *Tone* and *Tine* parameters can also be set on the **Play** view.

The Release Time

The *Release* knob in the **Fork** module applies both to the tone and tine bars and is used to control the decay time of the fork oscillations when a key is released and dampers are applied on the fork. Turning this knob clockwise increases this release time. Note that this parameter is different from the *Decay* parameter on the tone and tine bar settings which determine the decay time of the tone and tine oscillations when there is no damper applied to the fork. The characteristics of the noise produced by the dampers when they are applied on the fork are adjusted in the **Damper** module as will be described in section 5.2.4.

5.2.3 The Pickup Module

The **Pickup** module simulates the way a magnetic coil captures the sound of the fork in an electric piano.

The position of the pickup relative to the tine bar is a very important parameter in determining the tone of the instrument. Indeed, the shape of the signal measured by the pickup strongly depends on how it is positioned with respect to the tine bar. This geometric parameter is fully adjustable on the **Lounge Lizard EP**, as illustrated in Figure 8 for a wide range of tonal colors.

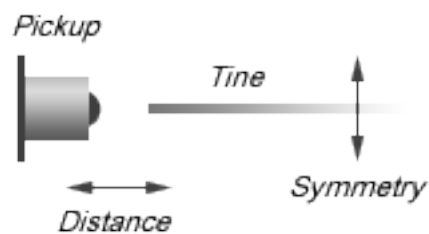
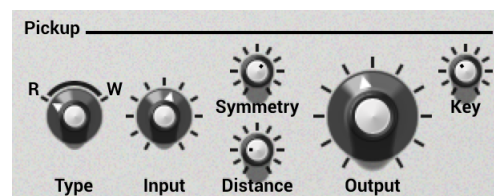

Figure 8: Position of the pickup relative to the tine bar.

The *Symmetry* knob is used to adjust the vertical position of the pickup relative to the tine bar. In its leftmost position, the pickup is right in front of the tine producing more harmonics in the sound. Turning the knob clockwise, moves the pickup above the tine resulting in a more mellow tone. Note that this control only allows one to move the pickup above the tine, this is because moving the pickup below the



tone bar present in the final sound. Turning this knob clockwise results in a louder sound from the tone bar. The *Decay* knob controls the time necessary for the oscillations of the tone bar to fade out when a key is depressed and a note is held. Turning this knob clockwise increases the decay time.

tine has the same effect on the spectrum of the sound as moving it above by the same amount. The *Symmetry* parameter is also adjustable from the **Play** view.

The *Distance* knob sets the horizontal distance between the pickup and the tine bar. Turning this knob clockwise, increases this distance and moves the pickup away from the tine. Note that the sound becomes more distorted (overdriven) as the pickup is moved closer to the tine.

The *Lounge Lizard EP* uses two different types of pickups in order to expand the tonal possibilities of the instrument. The *Type* switch is used to select the type of pickup types used by *Lounge Lizard EP*. In the *R* position, *Lounge Lizard EP* uses a model of electro-dynamic pickups. In the *W* position, the model used is that of an electro-static pickups.

The *Input* knob is used to adjust the amount of signal from the fork going into the pickup which will affect the amount of distortion applied to the signal by the pickup. As the knob is turned clockwise, the amount of input signal increases. The *Output* knob controls the amount of signal from the pickup and sent to the effect section. As the knob is turned clockwise, this amount increases. Note that the *Output* signal can be modulated with the pitch of the note played by using the *Key* knob. Turning this knob to the left will increase the output amplitude of low notes relative to high notes while turning the knob to the right will have the opposite effect and increase the relative amplitude of high notes. In its center position, the output amplitude is uniform across the entire keyboard.

One can obtain different sounds with different settings of the *Input* and *Output* parameters. For example, a small amount of input with higher amount of output will produce a cleaner sound than a large amount of input with small output value.

5.2.4 The Damper Module

The **Damper** module simulates the production of noise when dampers are raised from or applied on the fork when a key is depressed or released. This gives a more realistic and lively sound.

The *Amount* knob is used to set the amplitude (volume) of the damper noise present in the final sound. Turning the knob clockwise increases the presence of the damper noise in the final sound.

The *Tone* knob is used to adjust the stiffness of the dampers. When in its leftmost position, the dampers are soft producing a more mellow sound. Turning the knob clockwise increases the stiffness of the dampers and the center frequency of the noise produced by the damper.

Finally, the *Att Rel* knob is used to control the amount of noise introduced by the dampers at the beginning or end of a note when the dampers are either lifted from the fork or applied on the fork. When turned to the left, in the *Att* position, noise will be introduced in the sound during the attack phase of notes while in the *Rel* position, noise will be added during the release phase of notes. In its center position, an equal amount of noise will be added both during the attack and release phases of notes.

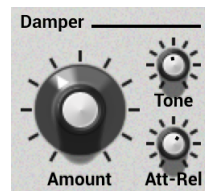

Note that the **Damper** module responds to the sustain pedal signal via the Damper MIDI Control Change message (CC#64). In order for *Lounge Lizard EP* to respond to a sustain pedal, simply set your synth or MIDI controller to send its sustain pedal signal via this MIDI Control Change message.

5.2.5 The Tremolo Module

The **Tremolo** module, introduces low frequency amplitude modulation, or tremolo, in the sound. This is an effect extensively used with electric pianos. The effect is switched *on* or *off* using the *On* button.

The *Type* selector enables one to select the shape of the wave that creates the tremolo. The triangle wave gives a more regular (smoother) tremolo while the soft square wave gives a more chopped effect.

The *Stereo* button is used to determine if the tremolo is mono or stereo. When the button is depressed, the tremolo is *on* and in stereo mode otherwise it is in mono mode. In stereo mode, the sound bounces with a 180 degrees phase from left to right while in mono mode it is the same on the left and right channels.

The *Depth* is used to set the amount of modulation in the amplitude of the signal in other words the amount of tremolo effect. In its leftmost position, the amplitude is not modulated and turning the knob clockwise gradually increases the amplitude of the modulation.

The *Rate* knob controls the frequency of the modulation. Turning the knob clockwise increases this frequency and results in a faster modulation rate. Note that this knob is active only when the *Sync* button is in its *off* position.

Both the *Depth* and *Rate* parameters can be adjusted from the **Play** view. The **Tremolo** module can also be switched *on* or *off* from the same view. Finally note that the *Depth* parameter can also be controlled by the modulation wheel appearing on the **Play** view or that from your MIDI keyboard as explained in Section 5.4



5.3 The FX View

The **FX** view is displayed by clicking on the *FX* button in the utility section at the top of the interface and is based around a **Multi-effects** module.

The **Multi-Effects** module allows one to process and shape the signal from the piano before sending it to the output. This module comprises an **EQ** and a **Compressor** in series with two configurable effect processors and a **Reverb**. The configuration of the **EQ** and the **Compressor** module depends on the position of the *SC* and *Pre* buttons of these modules as will be explained below. The two effect processors can be set to a different type by using the drop-down menu located at the center of each module for a wide range of possibilities. The effect list includes a **Delay**, **Distortion**, **Chorus**, **Flanger**, **Phaser**, **Wah Wah**, **Auto Wah** and a **Notch** filter.

The **Multi-Effects** module is also visible from the **Play** view just below the utility section. This allows one to see rapidly which effects are selected for a given sound, turn the effects *on* or *off* and rapidly adjust the amount of each effect. The **Compressor**, **Equalizer** and **Reverb** can also be adjusted from this view.

5.3.1 EQ

The **EQ** module provides equalization over the low, mid, and high frequency bands. It is composed of a low shelf filter, two peak filters, and a high shelf filter in series, labelled **LF**, **LMF**, **HMF**, and **HF** respectively.

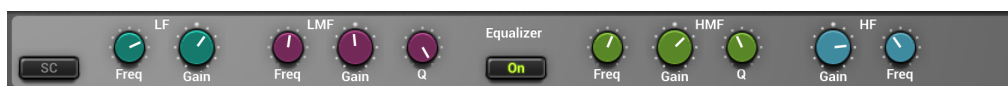

The functioning of the low shelf filter is depicted in Figure 9. The filter applies a gain factor to low frequency components located below a cutoff frequency while leaving those above unchanged. The cutoff frequency of this filter is adjusted using the *Freq* knob and can vary between 40 and 400 Hz. The *Gain* knob is used to adjust the gain factor applied to the signal in a ± 15 dB range. In its center position there is no attenuation (0 dB). Turning it clockwise boosts the amplitude of low frequencies while turning it anti-clockwise reduces it.

The high frequency content of the signal is controlled with a high shelf filter that works in the opposite manner as the low shelf filter as illustrated in Figure 9. The filter applies a gain factor to components located above a cutoff frequency while leaving those below unchanged. The cutoff frequency of this filter, located above 1 kHz, is adjusted with the help of the *Freq* knob while the gain factor applied to the signal, in a ± 15 dB range, is adjusted using *Gain* knob. In its center position there is no attenuation (0 dB). Turning it clockwise boosts the amplitude of high frequencies while turning it anti-clockwise reduces it.

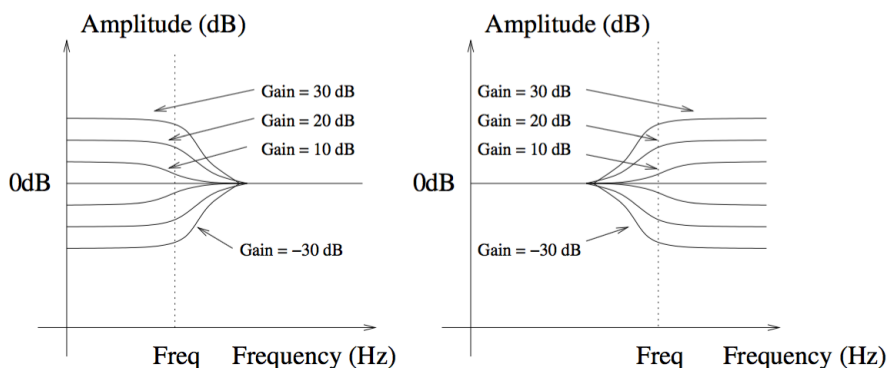

Figure 9: Low and high shelf filters.

The **EQ** module features two peak filters, labeled **LMF** and **HMF**, allowing to shape the signal in two frequency bands as illustrated in Figure 10. The filters apply a gain factor to frequency

components in a band located around the cutoff frequency of the filters. This cutoff frequency is adjusted using the *Freq* knob and can vary between 100 Hz and 10 kHz. The gain factor applied at the cutoff frequency is controlled by the *Gain* knob and can vary in a ± 15 dB range. When in its center position there is no attenuation (0 dB). Turning it clockwise boosts the amplitude of frequencies located around the cutoff frequency while turning it anti-clockwise reduces it. The *Q* knob is used to adjust the so-called quality factor of the filter which controls the width of the frequency band on which the filter is active. In its leftmost position, the frequency band is wide and it gets narrower as the knob is turned clockwise.

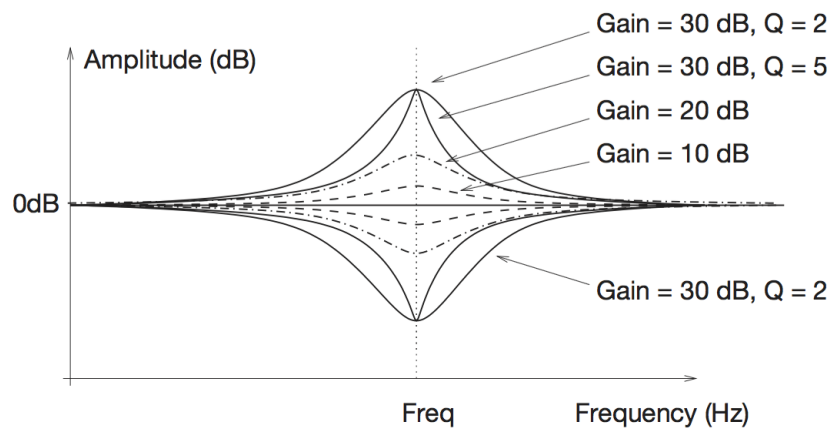
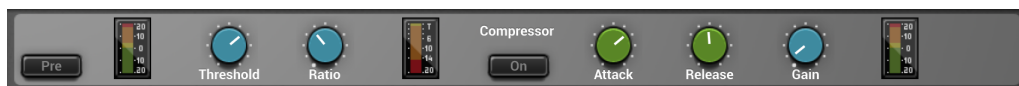

Figure 10: Peak filter.

The **SC** button (side-chain) is used to determine if the output from the **EQ** module is to be used as the control signal of the **Compressor** module as described in Section 5.3.2. Finally, note that all the gain knobs from this module can be accessed directly from the **Play** view.

5.3.2 Compressor



The **Compressor** module is used to automatically compress, in other words reduce, the dynamics of a signal. This module receives two input signals. The first one is the signal to be compressed while the second one is a control signal which triggers the compression process when it rises above a given level.

Tuning

The level at which the **Compressor** starts to enter into action is determined by the value of the *Threshold* parameter. This value is in dB and corresponds to the amplitude of the input signal as

monitored by the first level meter of the module.

The amount of compression applied to the part of the signal exceeding the threshold value depends on the *Ratio* parameter which varies between value of 1:1 and 1:16. This parameter represents the ratio, in dB, between the portion of the output signal from the compressor above the threshold value and the portion of its input signal also exceeding the threshold value. As one might expect, increasing the ratio also increases the amount of compression applied to the signal. For example, a ratio of 1:5 means that if the input signal exceeds the threshold by 5 dB, the output signal will exceed the threshold by only 1 dB. Note that the *Ratio* parameter can also be adjusted from the **Play** view.

Two other controls affect the behavior of the **Compressor**. The *Attack* knob is used to set the time, in milliseconds, before the **Compressor** fully kicks in after the level of the input has exceeded the threshold value. A short value means that the compressor will reach the amount of compression as set by the *Ratio* knob rapidly. With a longer attack, this amount will be reached more gradually. In other words, the attack time is a measure of the attack transient time of the compression effect. The **Release** parameter is similar and represents the amount of time taken by the **Compressor** to stop compressing once the amplitude of the input signal falls below the threshold value.

The **Makeup** knob is used to adjust the overall level at the output of the **Compressor** module and is used to compensate from an overall change in signal level due to the compression effect.

The location of the **Compressor** in the signal path depends on the setting of the *Pre* button. When this knob is *on*, the **Compressor** is located at the output from the piano, just before the **EQ** module. In this position, the input signal of the **Compressor** and its control signal are both the output signal from the piano. When the **Pre** button is *off*, the **Compressor** is located after the **EQ** module. In this configuration, the control signal of the **Compressor** is then the output signal from the **EQ** module. The input signal to the compressor is determined by the position of the **SC** button. When it is *on*, the **Compressor** is in a *side-chain* configuration. The input of the **Compressor** is then the output signal from the piano. When it is *off*, the input of the **Compressor** is the output signal from the **EQ** module.

Using the compressor in side chain configuration is useful when one wants to trigger the compressor using other criteria than the general level of the signal to be compressed. For example, a sound with a lot of bass would easily trigger the **Compressor** when playing low notes. In order to avoid that, the **EQ** module would be set to filter out low frequency components. This signal would then be used to control the **Compressor** while the input signal to the **Compressor** would still include these low frequency components.

The attenuation or gain reduction level meter, located in the middle of the module, indicates the amount of compression applied by the module. It is the difference between the input and output signals of the module before makeup gain is applied.

5.3.3 Delay

The **Delay** module consists in a stereo feedback loop with a variable delay in the feedback. It is used to produce an echo effect when the delay time is long (greater than 100 ms) or to color the sound when the delay time is short (smaller than 100 ms).

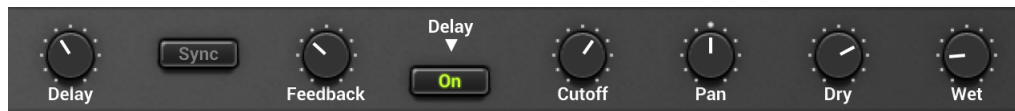

The *Delay knob* is used to adjust the amount of delay, in seconds, introduced by the effect. Turning this knob clockwise increases the delay. The *Feedback* parameter is a gain factor, varying in the range between 0 and 1, applied to the signal at the end of the delay lines. It controls the amount of signal that is re-injected in the feedback loop. In its leftmost position, the value of this parameter is 0 and no signal is re-introduced in the delay line which means that the signal is only delayed once. Turning the knob clockwise increases the amount of signal re-injected at the end of the feedback loop and therefore allows one to control the duration of the echo for a given delay time. In its rightmost position, the gain coefficient is equal to 1 which means that all the signal is re-injected into the feedback loop and that the echo will not stop. In addition to this gain factor, low pass filtering can also be applied to the signal re-injected into the feedback loop. The cutoff frequency of this filter is controlled using the *Cutoff* knob.

The *Pan* knob is used to balance the input signal between the left and right channels. In its leftmost position, signal will only be fed into the left delay line and one will hear clearly defined echo first from the left channel and then from the right channel and so on. In its rightmost position, the behavior will be similar but with the first echo coming from the right channel. These two extreme position correspond to the standard ping pong effect but a less extreme behavior can be obtained by choosing an intermediate position. In particular when the *Pan* knob is in its center position, an equal amount of signal is sent in both channels.

The output signal from the **Delay** module can include a mix of input signal (dry) and delayed signal (wet). The *Wet* and *Dry* knobs are used to adjust the amplitude of each component in the final output. The amplitude of each component is increased by turning the corresponding knob clockwise from no signal to an amplitude of +6dB. Note that the *Wet* parameter is also adjustable from the **Play** view.

5.3.4 Distortion

The **Multi-Effect** module includes three different types of distortion which are selected using the *Shape* selector knob. The *Warm Tube* effect applies a smooth symmetrical wave shaping to the input signal resulting in the introduction of odd harmonics in the signal. The *Metal* distortion is similar to the *Warm Tube* effect but is slightly asymmetrical resulting in the introduction of even and odd harmonics in the signal. The *Solid State* distortion applies an aggressive symmetrical clipping to the signal thereby adding high frequency harmonics and resulting in a harsh sound.



The *Drive* control is a gain knob acting on the input signal. This parameter allows one to adjust the amount of distortion introduced in the signal by controlling how rapidly the signal reaches the non-linear portion of the distortion curve applied on the signal. In its leftmost position, the amplitude of the input signal is reduced by -6 dB; turning this knob clockwise allows one to increase its amplitude. Note that the *Drive* parameter is also adjustable from the **Play** view.

The *Tone* knob is used to adjust the color of the signal after the distortion algorithm has been applied. In its leftmost position, high frequencies will be attenuated in the signal while in its rightmost position low frequencies will be filtered out from the signal. In its center position, the signal will be left unchanged.

The *Volume* knob is a gain knob acting on the amplitude of the distorted signal. Finally, the *Mix* knob allows one to control the amount of dry and wet (distorted) signal in the final output signal from the **Distortion** module. In its leftmost position, there is only dry signal in the output while in its rightmost position one only hears the distorted signal. In its center position, there is an equal amount of dry and wet signal in the output.

5.3.5 Chorus

The chorus effect is used to make a source sound like many similar sources played in unison. It simulates the slight variations in timing and pitch of different performers executing the same part. The effect is obtained by mixing the original signal with delayed version obtained from the output of delay lines as shown in Figure 11. In the case of a chorus effect, the length of the delay lines must be short in order for the delayed signals to blend with the original signal rather than be perceived as a distinct echo. The length of the delay line can be modulated introducing a slight perceived pitch shift between the voices.

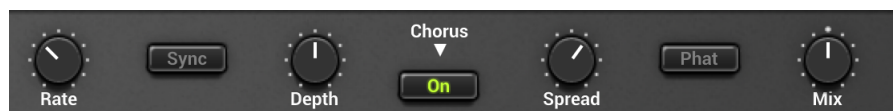

Tuning

The amount of modulation of the length of the delay lines is adjusted using the *Depth* knob. In the left position, there is no modulation and the length of the delay lines remains constant. As the knob is turned to the right, the length of the delay line starts to oscillate by an amount which increases as the knob is turned clockwise thereby increasing the amount by which the different voices are detuned. The frequency of the modulation is fixed with the *Rate* knob.

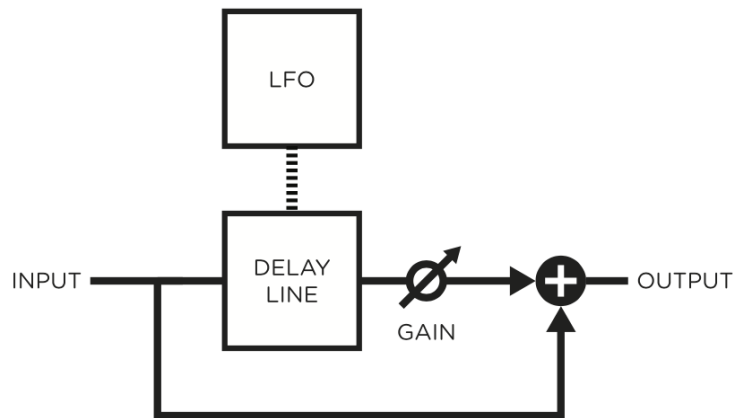
Figure 11: **Chorus** module.

The *Fat* button is used to control the number of voices in the chorus effect. Switching this button *on* increases the number of voices. The *Spread* knob is used to adjust the amount of dispersion of the different voices in the stereo field. When in its leftmost position, there is an equal amount of left and right output signal on each channel. In other words the signal is the same on both channels. In its rightmost position, there is complete separation between the channels, the left output from the chorus is only sent to the left channel while the right output of the chorus is only sent to the right channel. Finally, the *Mix* knob allows one to mix the dry and wet signals. In its leftmost position, there is no output signal from the chorus and one only ears the dry input signals. In its rightmost position, one only ears the wet signal from the chorus module. In its center position, there is an equal amount of dry and wet signal in the output signal from the module.

5.3.6 Flanger

The **Flanger** module implements the effect known as *flanging* which colors the sound with a false pitch effect caused by the addition of a signal of varying delay to the original signal.

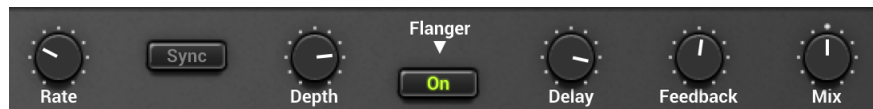

The algorithm implemented in this module is shown in Figure 12. The input signal is sent into a variable delay line. The output of this delay is then mixed with the dry signal and re-injected into the delay line with a feedback coefficient.

The effect of the **Flanger** module is to introduce rejection in the spectrum of the input signal at

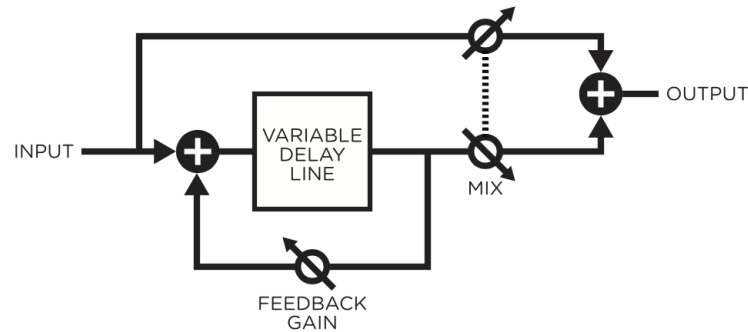

Figure 12: **Flanger** algorithm.

frequencies located at odd harmonic intervals of a fundamental frequency as shown in Figure 13. The location of the fundamental frequency f_0 and the spacing between the valleys and peaks of the frequency response is determined by the length of the delay line ($f_0 = 1/(2\text{delay})$), the longer the delay, the lower is f_0 and the smaller the spacing between the harmonics while decreasing the delay increases f_0 and hence the distance between the harmonics.

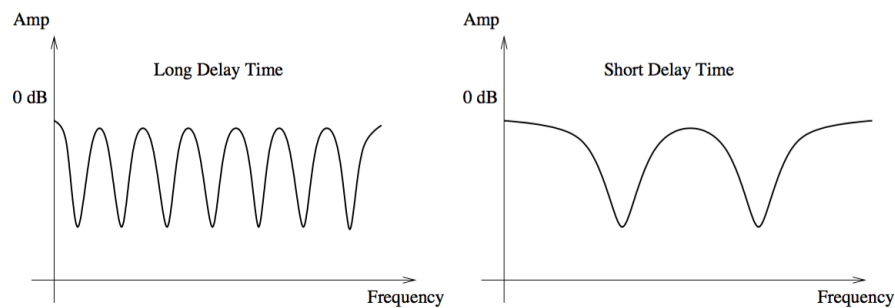

Figure 13: Frequency response of a **Flanger** module. Effect of the length of the delay line.

The amount of effect is determined by the ratio of wet and dry signal mixed together as shown in Figure 14. As the amount of wet signal sent to the output is increased, the amount of rejection increases. Finally, the shape of the frequency response of the **Flanger** module is also influenced by the amount of wet signal re-injected into the feedback loop as shown in Figure 15. Increasing the feedback enhances frequency components least affected by the delay line and located at even harmonic intervals of the fundamental frequency. As the feedback is increased, these peaks become sharper resulting in an apparent change in the pitch of the signal.

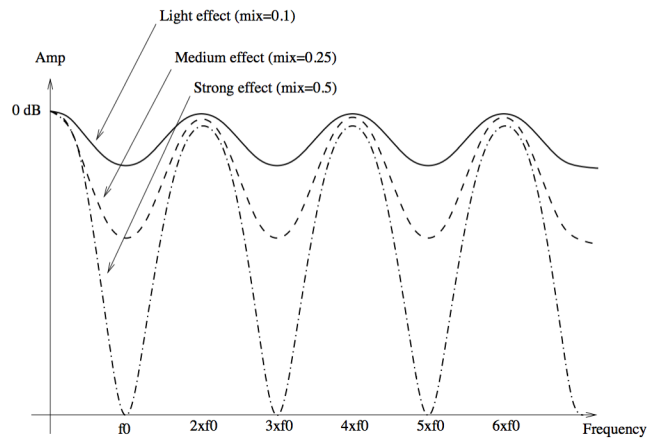

Figure 14: Effect of the mix between wet and dry signal on the frequency response of a **Flanger** module

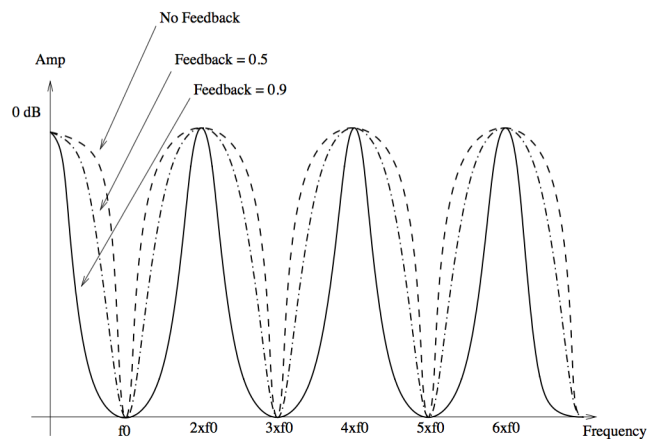

Figure 15: Effect of the amount of feedback on the frequency response of a **Flanger** module.

Tuning

The delay length, in milliseconds, is adjusted with the *Delay* knob. The length of this delay can be modulated by a certain amount depending on the adjustment of the *Depth* knob. In the left position, there is no modulation and the length of the delay line remains constant. As the knob is turned to the right, the length of the delay line starts to oscillate by an amount which increases as the knob is turned clockwise and at a frequency fixed with the *Rate* knob. The *Feedback* knob is a gain knob used to fix the ratio of wet signal re-injected into the delay. Finally, the *Mix* knob determines the amount of dry and wet signal in the output signal from the module. When this knob is adjusted in its leftmost position, only dry signal is sent to the output, in its center position, there is an equal amount of dry and wet signal in the output signal while in its rightmost position, only wet signal is sent to the output. Note that the *Depth* parameter is also adjustable from the **Play** view.

5.3.7 Phaser

The **Phaser** module implements the effect known as *phasing* which colors a signal by removing frequency bands from its spectrum. The effect is obtained by changing the phase of the frequency components of a signal using an all-pass filter and adding this new signal to the original one.

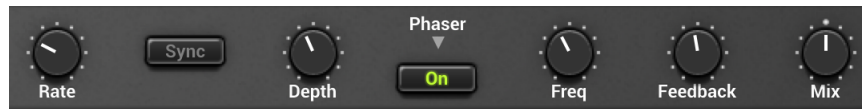

The algorithm implemented in this module is shown in Figure 16. The input signal is sent into a variable all-pass filter. This wet signal is then mixed down with the original dry signal. A feedback line allows the resulting signal to be re-injected into the filter. The effect of the **Phaser** module is to introduce rejection in the spectrum of the input signal depending on the tuning of the filter.

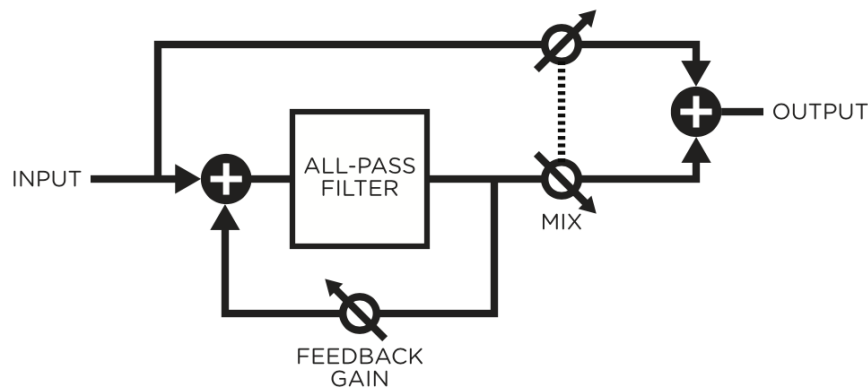

Figure 16: **Phaser** algorithm.

The all-pass filter modifies a signal by delaying its frequency components with a delay which increases with the frequency. This phase variations will introduce a certain amount of cancellation when this wet signal is mixed down with the original dry signal as shown in Figure 17. The rejection is maximum when the phase delay is equal to 180 degrees and a given component is out of phase with that of the original signal. The amount of effect is determined by the ratio of wet and dry signal mixed together as shown in Figure 17. As the amount of wet signal sent to the output is reduced, the amount of rejection increases. The shape of the frequency of the Phaser module is also influenced by the amount of wet signal re-injected into the feedback loop. Increasing the feedback enhances frequency components least affected by the all-pass filter. As the feedback is increased, these peaks become sharper. The functioning of the **Phaser** is very similar to that of the **Flanger**

module. The filtering effect is different however, since the **Phaser** module only introduces rejection around a limited number of frequencies which, in addition, are not in an harmonic relationship.

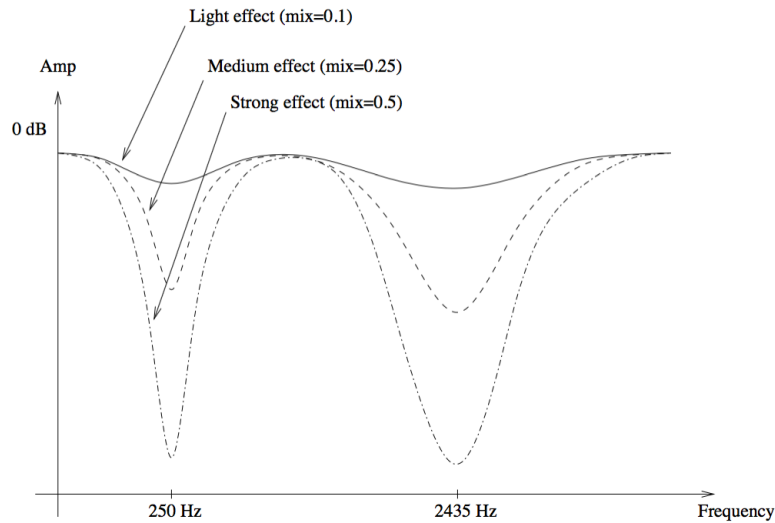

Figure 17: Frequency response of a **Phaser** module. Effect of the mix between wet and dry signal on the frequency response.

Tuning

The location of the first notch in the frequency response of the module is adjusted with the *Frequency* knob. This frequency can be modulated by an amount controlled with the *Depth* knob. In its leftmost position, the location of the first notch is fixed but it starts to oscillate by an amount which increases as the *Depth* knob is turned clockwise. The frequency of the modulation is controlled using the *Rate* knob. The *feedback* knob is used to fix the amount of wet signal re-injected into the delay. Finally, the *Mix* knob determines the amount of dry and wet signal sent to the output. When this knob is adjusted in the left position, only dry signal is sent to the output, in its center position, there is an equal amount of dry and wet signal in the output and in the right position, only wet signal is sent to the output.

5.3.8 Wah

The Multi-Effect module includes 2 different types of *Wah* effects: wah wah, and auto wah. These effects are used to enhance a frequency band around a varying center frequency using a bandpass filter. In the wah wah effect, the center frequency of the bandpass filter varies at a rate fixed by the user. In the case of the auto-wah, the variations of the center frequency is controlled by the amplitude envelope of the incoming signal.



The *Freq* knob is used to control the central frequency of the filter. Turning this knob clockwise increases the center frequency. In the case of the *Wah Wah* effect, the center frequency will oscillate around the value fixed by the *Freq* knob while with the *Auto Wah* effect, the setting of the *Freq* will fix the starting point value of the varying center frequency.



The *Depth* knob controls the excursion of the center frequency of the filter. In the case of the *Wah Wah* effect, this excursion is applied around the value fixed by the *Freq* knob while in *Auto Wah* effect the value of the center frequency increases from the value fixed by the *Freq* knob. Turning this knob clockwise increases the excursion of the center frequency. Note that the *Depth* parameter is also adjustable from the **Play** view.

Finally, the *Rate* knob controls the frequency or rate of the modulation of the center frequency of the filter. In the case of the *Wah Wah* effect, turning this knob clockwise increases the rate of the modulation. In the case of the *Auto Wah* filter, this knob is labeled *Speed* and controls the time constant of the envelope follower. Turning this knob clockwise decreases the time constant, or in other words the reaction time, of the envelope follower.

5.3.9 Notch Filter

The *Notch Filter* does essentially the opposite of a band-pass filter. It attenuates the frequencies in a band located around the center frequency and leaves those outside of this band unchanged as shown in Figure 18. As was the case for the *Wah Wah* effect, the filter can be modulated.

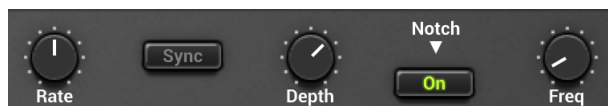

The *Freq* knobs is used to control the central frequency of the filter. Turning this knob clockwise increases the center frequency. The *Depth* knob controls the excursion of the center frequency of the filter around its center frequency. Turning this knob clockwise increases the excursion of the center frequency. Finally, the *Rate* knob controls the frequency or rate of the modulation of the center frequency of the filter. Turning this knob clockwise increases the rate of the modulation. Note that the *Depth* parameter is also adjustable from the **Play** view.

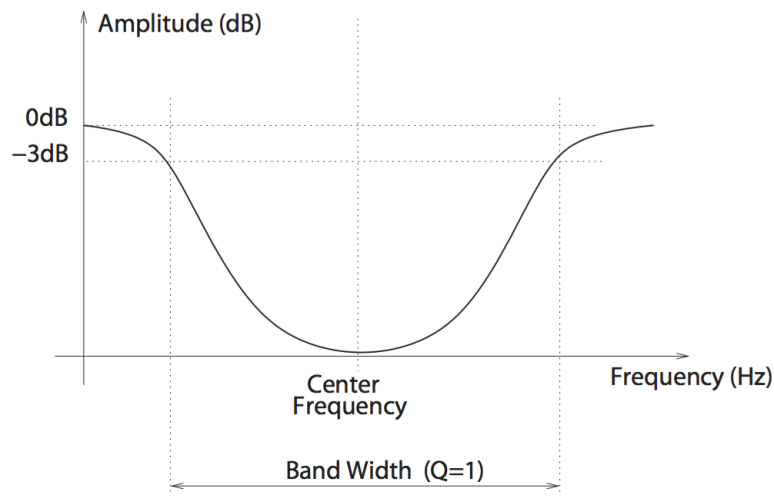

Figure 18: Frequency response of a notch filter.

5.3.10 Reverb

The *Reverb* effect is used to recreate the effect of reflections of sound on the walls of a room or hall. These reflections add space to the sound and make it warmer, deeper, as well as more realistic since we always listen to instruments in a room and thus with a room effect.

Impulse Response of a Room

The best way to evaluate the response of a room is to clap hands and to listen to the resulting sound. Figure 19 shows the amplitude of the impulse response of a room versus time. The first part of the response is the clap itself, the direct sound, while the remaining of the response is the effect of the room which can itself be divided in two parts. Following the direct sound, one can observe a certain amount of echoes which gradually become closer and closer until they can not be distinguished anymore and can be assimilated to an exponentially decaying signal. The first part of the room response is called the early reflexion while the second is called the late reverberation. The total duration of the room response is called the reverberation time (RT).

Adjusting the room effect

The size of a room strongly affects the reverberation effect. The *Size* selector is used to choose between the *Studio*, *Club*, *Hall* and *Large Hall* settings each reproducing spaces of different volumes from smaller to larger.

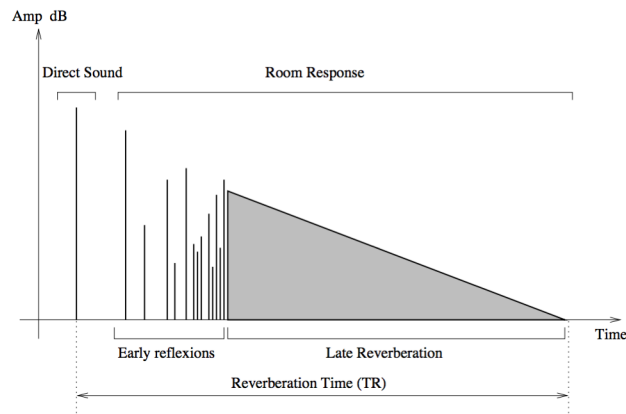
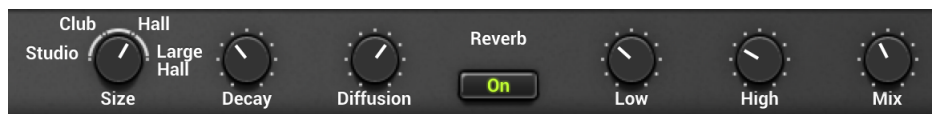

Figure 19: Impulse response of a room.

The duration of the reverberation time depends on both the size of the room and the absorption of the walls, which is controlled with the *Decay* knob. In a real room the reverberation time is not constant over the whole frequency range. As the walls are often more absorbent in the very low and in the high frequencies the reverberation time is shorter for these frequencies. These parameters are adjusted with the *Low* and *High* knobs respectively.

Another parameter which affects the response of a room is its geometry; the more complex the geometry of a room, the more reflexion are observed per unit of time. This quantity is known as the time density and can be set trough the *Diffusion* knob. In a concert hall, the time density is supposed to be quite high in order not to hear separate echoes which are characteristic of poor sounding rooms. The last parameter which affects our listening experience in a room, is the distance



between the sound source and the listener. While the room response is quite constant regardless of the position of the source and the listener, the direct sound (the sound which comes directly from the source) depends strongly on the position of the listener. The farther we are from the sound source the quieter is the direct sound relatively to the room response. The ratio between the direct sound and the room response is adjusted with the *Mix* knob which in other words is used to adjust the perceived distance between the source and the listener. In its leftmost position, only the direct sound is heard while when fully turned to the right, one only hears the room response. Note that the *Mix* parameter is also adjustable from the **Play** view.

5.4 The Play View

The **Play** view groups together the main parameters from the **Edit** and **FX** views. It is loaded when starting the instrument and can be accessed from another view by clicking on the *Play* button on the top part of the interface.

The middle section of this view allows one to switch *on* and *off* the **EQ**, **Compressor** and **Reverb** as well as the active effect modules. Key effect parameters are also adjustable as presented in the description of the different effect modules in section 5.3



The lower part of this view is dedicated to piano parameters. Key controls are provided as described in section 5.2. This section also includes a so-called *Character* parameter that is only accessible from this view. This parameter provides five (5) classic studio and stage signal path emulations, in other words the speaker, cabinet, pre-amp, microphone and recorder chain that follow the piano output and give different colors to the original piano sound. When this knob is in its leftmost position, no profile is applied and one can hear the direct output from the piano. Turning this knob to the right allows one to choose between the five different profiles which vary from less to more pronounce in character. Adding character might not always be necessary but it may help to find your sound to find its right place in a mix.



Pitch Wheel

The MIDI pitch wheel allows one to vary the pitch of the piano. The pitch wheel can be moved with the mouse but it is also automatically connected to the pitch wheel signal received from your MIDI keyboard.

The range of the pitch bend is 2 semi-tones up or down by default but can be changed. To adjust the range of the pitch bend, open the MIDI configuration window by clicking on the **MIDI** button located just below the MIDI let in the top part of the interface and use the **Pitch Bend Range** drop-down menu to select the range in semi-tones.

Modulation Wheel

The modulation wheel is linked to the *Depth* parameter of the **Tremolo** module. It can be activated on screen or from the modulation wheel of your MIDI controller (MIDI controller number 1). By default, the modulation wheel is inactive. The value of the *Depth* parameter of the **Tremolo** module is then fixed by the value saved in the currently loaded program. Upon touching the modulation wheel, the *Trem* switch located below the wheel, starts to blink. Once this switch is turned *on*, the value of the *Depth* parameter follows the position of the modulation wheel. Note that the position of the *Trem* switch is not saved in a program which means that once it is turned *on*, it will remain so until it is switched *off* even if new programs are loaded.

Ribbon

The lower part of this view includes a ribbon controller. The ribbon covers seven octaves and notes are played when clicking on the ribbon. The ribbon is useful to test sounds when no MIDI keyboard is connected to your computer.

6 Utility Section

The utility section is located at the top of the *Lounge Lizard EP* interface and it includes important parameters and monitoring tools. For information on *Banks* and *Programs* please refer to Chapter 4

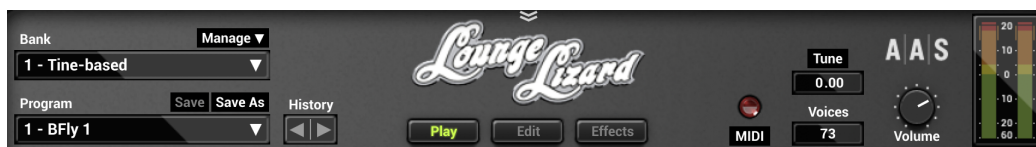

6.1 The MIDI LED

The MIDI LED is located on the left of the level-meter. The LED blinks when the synthesizer receives MIDI signal. If the application is not receiving MIDI signal, make sure that the host sequencer is sending MIDI to *Lounge Lizard EP*. If you are running in standalone mode, make sure that the MIDI controller you wish to use is well connected to your computer and that it is selected as explained in Section 7.

6.2 Polyphony

The *Voices* control located in the upper left corner of this section allows one to adjust the number of polyphony voices used by *Lounge Lizard EP*. The number of voices is adjusted by clicking on the control and selecting the desired number of voices. In general, a higher number of voices is desirable but keep in mind that the CPU load is proportional to the number of voices used.

6.3 Tuning

The *Tune* control, located to the right of the MIDI LED, is used to transpose the frequency of the keyboard. This control is composed of two numbers separated by a dot. The first number indicates a value in semi-tones while the second one indicates a value in cents (one hundredth of a semi-tone). The amount of transposition can be adjusted by click-dragging upward or downward on the semi-tone and cent controls. Double clicking on these controls brings back their value to zero. When the value of the *Tune* parameters is set to 0.00, the frequency of notes are calculated relative to A4 with a frequency of 440Hz.

An interesting feature of *Lounge Lizard EP* is that it can be tuned using different temperaments using Scala micro-tuning files. Temperament files are loaded by clicking on the *Tune* button which opens the Tuning pop-up window and displays the list of available tuning temperament files available.

By default, *Lounge Lizard EP* is set to stretched Temperament but equal temperament is also installed. Other files can be added to the list by copying them to the following folders:

On **Mac OS**:

/Users/[user name]/Library/Application Support/Applied Acoustics Systems/Scala Tunings/

On **Windows**:

%AppData%\Applied Acoustics Systems\Scala Tunings\

These folders can be displayed directly from *Lounge Lizard EP* by clicking on the *Show Tuning Files* button at the bottom of the *Tuning* pop-up window.

Selecting a Scala file in the list automatically triggers the loading of the corresponding temperament. The reference note that will be used as the base note for the scale described in the Scala file can be set using the Reference Note control appearing at the bottom of the *Tuning* window. The frequency of this reference note is calculated relative to the settings of the *Tune* control. Please note that the reference note does not appear in the window when the default temperament is chosen, it only appears once a Scala file is loaded.

6.4 History and Compare

The *History* control allows one to go back through all the modifications that were made to programs since the application was started. In order to travel back and forth in time, use the left and right-pointing arrows respectively. The application will switch between different program states and indicate the time at which they were modified.

The *Compare* button, located above the *Program* display, is used to switch between **Edit** and **Compare** mode. This button is visible only once a modification is applied to a given program. It allows one to revert to the original version of a program in order to compare it with the current version. When in **Compare** mode, edition is blocked and it is therefore not possible to modify any parameter. The **Compare** mode must then be switched off by clicking on the *Compare* button in order to resume edition.

6.5 Volume

The *Volume* knob is the master volume of the application. It is used to adjust the overall level of the output signal from the synthesizer. General level is increased by turning the knob clockwise.

6.6 Level Meter

The level meter allows one to monitor peak and RMS (root means square) level of the left (L) and right (R) output channels from the synthesizer. As a limiter is located at the output of *Lounge Lizard EP*, it is important to make sure that the amplitude of the signal remains within values that ensure that no distortion is introduced in the signal at the output.

The 0 dB mark on the level meter has been adjusted to correspond to -20 dBFS (full scale). This means that at that level, the signal is -20 dB below the maximum allowed value. This 0 dB level mark should typically correspond to playing at mezzo forte (moderately loud) level. This ensures a headroom of 20 dB which should be more than enough to cover the dynamics of most playing situations and therefore guarantee that no additional distortion is added in the output signal.

A peak value mark allows one to follow the maximum level values reached by the output signal. The limiter is triggered when this mark enters the red zone of the level meter (17 dB) and it remains active while the side vertical bars at the top of the level meter are switched *On*.

6.7 The About Box

The **About** box is open by clicking on the chevrons located at the very top of the interface or on the product or company logo. The box is closed by clicking again on the chevrons or outside the box. Useful information is displayed in this box such as the program's version number, the serial number that was used for the authorization and the email address that was used for registration. The box also includes a link to the pdf version of this manual.

7 Audio and MIDI Settings

This chapter explains how to select and configure Audio and MIDI devices used by *Lounge Lizard EP*. Audio and MIDI configuration tools are accessed by clicking on the *Audio Setup* button located in the lower left corner of the *Lounge Lizard EP* interface and the *MIDI* button located just below the MIDI led in upper part of the interface.

Note that in plug-in mode the audio and MIDI inputs, sampling rate, and buffer size are set by the host sequencer.

7.1 Audio Configuration

7.1.1 Selecting an Audio Device

Audio configuration tools are available by clicking on the *Audio Setup* button located in the lower left corner of the *Lounge Lizard EP* interface. The **Audio Setup** dialog first allows you to select an audio output device from those available on your computer. Multi-channel interfaces will have their outputs listed as stereo pairs.

On Windows, the audio output list is organized by driver type. The device type is first selected from the **Audio Device Type** drop-down list. If you have ASIO drivers available, these should be selected for optimum performance. The *Configure Audio Device* button allows you to open the manufacturer's setup program for your audio interface when available.

Once the audio input has been selected, you can then select a sampling rate and a buffer size from those offered by your audio interface.

7.1.2 Latency

The latency is the time delay between the moment you send a control signal to your computer (for example when you hit a key on your MIDI keyboard) and the moment when you hear the effect. Roughly, the latency will be equal to the duration of the buffers used by the application and the sound card to play audio and MIDI. To calculate the total time required to play a buffer, just divide the number of samples per buffer by the sampling frequency. For example, 256 samples played at 48 kHz represent a time of 5.3 ms. Doubling the number of samples and keeping the sampling frequency constant will double this time while changing the sampling frequency to 96 kHz and keeping the buffer size constant will reduce the latency to 2.7 ms.

It is of course desirable to have as little latency as possible. *Lounge Lizard EP* however requires a certain amount of time to be able to calculate sound samples in a continuous manner. This time depends on the power of the computer used, the preset played, the sampling rate, and the number of voices of polyphony used. Note that it will literally take twice as much CPU power to process audio at a sampling rate of 96 kHz as it would to process the same data at 48 kHz, simply because it is necessary to calculate twice as many samples in the same amount of time.

Depending on your machine you should choose, for a given sampling frequency, the smallest buffer size that allows you to keep real-time for a reasonable number of voices of polyphony.

7.2 MIDI Configuration

7.2.1 Selecting a MIDI Device

The list of available MIDI inputs appears at the bottom of the **Audio Setup** dialog. Click on the *Audio Setup* button located in the lower left corner of the *Lounge Lizard EP* interface and then click on the checkbox corresponding to any of the inputs you wish to use.

7.2.2 Creating MIDI Links

Every control on the *Lounge Lizard EP* interface can be manipulated by an external MIDI controller through MIDI control change assignments. In most cases this is much more convenient than using the mouse, especially if you want to move many controllers at once. For example, you can map the motion of a knob on the interface to a real knob on a knob box or to the modulation wheel from your keyboard. As you use the specified MIDI controllers, you will see the controls move on the *Lounge Lizard EP* interface just as if you had used the mouse.

In order to assign a MIDI link to a controller:

- On the *Lounge Lizard EP* interface, right-click/Control-click on a control (knob, button) and select the **MIDI Learn** command.
- Move a knob or slider on your MIDI controller (this can be a keyboard, a knob box, or any device that sends MIDI). This will link the control of the *Lounge Lizard EP* to the MIDI controller you just moved.

To deactivate a MIDI link, simply right-click/Control-click on the corresponding control on the *Lounge Lizard EP* interface and select the **MIDI Forget** command.

7.2.3 Creating a default MIDI Map

It is possible to define a set of MIDI links, called a MIDI map, that will be loaded automatically when *Lounge Lizard EP* is launched. Once you have defined a set of MIDI links that you wish to save, click on *MIDI* button to open the *MIDI* configuration window and click on the **Save Current as Default** button.

If you make changes to MIDI links after opening the program and wish to revert to the default MIDI map click on *MIDI* button to open the *MIDI* configuration window and click on the **Load Default** button.

If you wish to deactivate all the MIDI links at once open the *MIDI* configuration window and click on the **Clear MIDI Map** button.

7.2.4 MIDI Program Changes

Lounge Lizard EP responds to MIDI program changes. When a program change is received, the current program is changed to the program having the same number as that of the program change message in the currently loaded bank.

If you do not wish *Lounge Lizard EP* to respond to MIDI program changes, open the *MIDI* configuration window by clicking on the *MIDI* button and uncheck the **Enable Program Changes** option.

7.2.5 MIDI Bank Changes

In general, MIDI bank numbers are coded using two signals: the MSB (most significant byte) and LSB (least significant byte) transmitted using MIDI CC (continuous controller) number 0 and 32 respectively. The way these signals are used differs with different manufacturers.

In the case of *Lounge Lizard EP*, the value of the MSB signal is expected to be zero while the value of the LSB signal represents the bank number. Banks are therefore numbered from 0 to 127 with this number corresponding to the position of a bank within the list of banks as displayed by the Bank manager (see Section 4.3). For example, an LSB value of 0 corresponds to the first bank in the bank list while an LSB value of 10 corresponds to the eleventh bank in the list. Note that a bank change only becomes effective after the reception of a new MIDI program change signal.

If you do not wish *Lounge Lizard EP* to respond to MIDI bank changes, open the *MIDI* configuration window by clicking on the *MIDI* button and uncheck the **Enable Bank Changes** option.

7.2.6 Pitch bend

The MIDI pitch wheel allows one to vary the pitch of *Lounge Lizard EP*. The pitch wheel can be moved with the mouse but it is also automatically connected to the pitch wheel signal received from your MIDI keyboard.

The range of the pitch bend is 2 semi-tones up or down by default but can be changed. To adjust the range of the pitch bend, open the MIDI configuration window by clicking on the **MIDI** button located just below the MIDI led in the top part of the interface and use the **Pitch Bend Range** drop-down list to select the range in semi-tones.

7.2.7 Modulation wheel

Lounge Lizard EP responds to MIDI modulation (MIDI controller number 1). For more details, please refer to Section 5.4.

8 Using *Lounge Lizard EP* as a Plug-In

Lounge Lizard EP is available in VST, AAX and AudioUnit formats and integrates seamlessly into the industry most popular multi-track recording and sequencing environments as a virtual instrument plug-in. *Lounge Lizard EP* works as any other plug-in in these environments so we recommend that you refer to your sequencer documentation in case you have problems running it as a plug-in. We review here some general points to keep in mind when using a plug-in version of *Lounge Lizard EP*.

8.1 Audio and MIDI Configuration

When *Lounge Lizard EP* is used as a plug-in, the audio and MIDI ports, sampling rate, buffer size, and audio format are determined by the host sequencer.

8.2 Automation

Lounge Lizard EP supports automation functions of host sequencers. All parameters visible on the interface can be automatized except for the **Polyphony**, **Bank**, **Program** and **History** commands.

8.3 Multiple Instances

Multiple instances of *Lounge Lizard EP* can be launched simultaneously in a host sequencer.

8.4 MIDI Program Change

MIDI program changes are supported in *Lounge Lizard EP*. When a MIDI program change is received by the application, the current sound used by the synthesis engine is changed to that having the same index, in the currently loaded pack, as that of the MIDI program change message.

8.5 Saving Projects

When saving a project in a host sequencer, the currently loaded program is saved with the project in order to make sure that the instrument will be in the same state as when you saved the project when you re-open it. Note that banks of programs are not saved with the project which implies that if you are using MIDI program changes in your project, you must make sure that the bank you are using in your project still exists on your disk when you reload the project. The programs must also exist and be in the same order as when the project was saved.

8.6 Performance

Using a plug-in in a host sequencer requires CPU processing for both applications. The load on the CPU is even higher when multiple instances of a plug-in or numerous different plug-ins are used. To decrease CPU usage, remember that you can use the **freeze** or **bounce to track** functions of the host sequencer in order to render to audio the part played by a plug-in instead of recalculating it every time it is played.

9 License Agreement

IMPORTANT! CAREFULLY READ ALL THE TERMS AND CONDITIONS OF THIS AGREEMENT BEFORE OPENING THIS PACKAGE. OPENING THIS PACKAGE INDICATES YOUR ACCEPTANCE OF THESE TERMS AND CONDITIONS. IF YOU DO NOT AGREE WITH THE TERMS AND CONDITIONS OF THIS AGREEMENT, PROMPTLY RETURN THE UNOPENED PACKAGE AND ALL COMPONENTS THERETO TO THE PARTY FROM WHOM IT WAS ACQUIRED, FOR A FULL REFUND OF ANY CONSIDERATION PAID.

This software program, any printed materials, any on-line or electronic documentation, and any and all copies of such software program and materials (the “**Software**”) are the copyrighted work of Applied Acoustics Systems DVM Inc. (“**AAS**”), its subsidiaries, licensors and/or its suppliers.

1. **LICENSE TO USE.** The Licensee is granted a personal, non-exclusive and non-transferable license to install and to use one copy of the Software on a single computer solely for the personal use of the Licensee. Use of the Software is subject to this Agreement.
2. **RESTRICTIONS ON USE.** The Licensee may not nor permit third parties to (i) make copies of any portion of the Software, other than as expressly permitted under this Agreement; (ii) modify, translate, disassemble, decompile, reverse engineer or create derivative and/or competitive products based on any portion of the Software; (iii) provide use of the Software in a network, timesharing, interactive cable television, multiple CPU service bureau or multiple user arrangement to users not individually licensed by AAS, other than as expressly permitted by the terms of this license. The Software is licensed to you as a single product. Its component parts may not be separated for use on more than one computer.
3. **OWNERSHIP.** AAS retains title to the Software, including but not limited to any titles, computer code, themes, objects dialog concepts, artwork, animations, sounds, audio effects, methods of operation, moral rights, any related documentation and “applets” incorporated into the Software. AAS retains ownership of and title to all intellectual property rights in the Software, underlying technology, related written materials, logos, names and other support materials furnished either with the Software or as a result of this Agreement, including but not limited to trade secrets, patents, trademarks and copyrights therein. Licensee shall not remove or alter any copyright or other proprietary rights notices contained on or within the Software and shall reproduce such notices on all copies thereof permitted under this Agreement or associated documentation.
4. **LIMITED WARRANTY.** Except for the foregoing, THE SOFTWARE IS provided “AS IS” without warranty or condition of any kind. AAS disclaims all warranties or conditions, written or oral, statutory, express or implied, including but not limited to the implied warranties of merchantable quality or fitness for a particular purpose, title and non-infringement of rights of any other person. AAS does not warrant that THE SOFTWARE will meet the Licensee’s requirements or that the operation of the software will be uninterrupted or ERROR-FREE.

5. **LIMITATION OF LIABILITY.** TO THE MAXIMUM EXTENT PERMITTED BY APPLICABLE LAW, IN NO EVENT WILL AAS BE LIABLE TO THE LICENSEE OR ANY THIRD PARTY FOR ANY INDIRECT, SPECIAL, CONSEQUENTIAL, INCIDENTAL OR EXEMPLARY DAMAGES WHATSOEVER, INCLUDING BUT NOT LIMITED TO LOSS OF REVENUE OR PROFIT, LOST OR DAMAGED DATA, BUSINESS INTERRUPTION OR ANY OTHER PECUNIARY LOSS WHETHER BASED IN CONTRACT, TORT OR OTHER CAUSE OF ACTION, EVEN IF AAS HAS BEEN ADVISED OF THE POSSIBILITY OF SUCH DAMAGES, EXCEPT IN RELATION TO GROSS NEGLIGENCE OR WILFUL BREACH OF THIS AGREEMENT BY AAS. NO AAS AGENT, REPRESENTATIVE OR DEALER IS AUTHORIZED TO EXTEND, MODIFY OR ADD TO THIS WARRANTY ON BEHALF OF AAS. THE TOTAL LIABILITY OF AAS FOR DAMAGES, WHETHER IN CONTRACT OR TORT, UNDER OR RELATED IN ANY WAY TO THIS AGREEMENT SHALL BE LIMITED TO THE LICENSE FEES ACTUALLY PAID BY LICENSEE TO AAS, OR IF NO FEES WERE PAID, AAS' LIST PRICE FOR THE SOFTWARE COVERED BY THIS LICENSE. THE EXCLUSION OF IMPLIED WARRANTIES AND/OR THE LIMITATION OF LIABILITY IS NOT PERMITTED IN SOME JURISDICTIONS, AND SOME OR ALL OF THESE EXCLUSIONS MAY THEREFORE NOT APPLY.
6. **TERMINATION.** This License also shall extend to the Software and any updates or new releases thereof obtained by the Licensee, if any, subject to any changes to this License made by AAS from time to time and provided to the Licensee, provided AAS is under a separate obligation to provide to Licensee such updates or upgrades and Licensee continues to have a valid license which is in effect at the time of receipt of each such update or new release. This License shall remain in effect until terminated. The Licensee may terminate this Agreement at any time, upon notification to AAS. This Agreement will terminate immediately without notice from AAS if the Licensee fails to comply with any provision of this License. Any such termination by AAS shall be in addition to and without prejudice to such rights and remedies as may be available, including injunction and other equitable remedies. Upon receipt of notice of termination from AAS, the Licensee must (a) immediately cease to use the Software; (b) destroy all copies of the Software, as well as copies of all documentation, specifications and magnetic media relating thereto in Licensee's possession or control; and (c) return all original versions of the Software and associated documentation. The provisions of Sections 1, 3, and 5 shall survive the termination of this Agreement.
7. **GOVERNING LAW.** This Agreement shall be governed by and construed in accordance with the laws of the Province of Quebec, without regard to the United Nations Convention On Contracts for the International Sale of Goods and conflict of laws provisions, if applicable, and the parties hereby irrevocably attorn to the jurisdiction of the courts of that province. Les parties sont d'accord à ce que cette convention soit rédigée en langue anglaise. The parties have agreed that this agreement be drafted in the English language.
8. **SEVERABILITY.** If any of the above provisions are held to be illegal, invalid or unenforceable, such provision shall be severed from this Agreement and this Agreement shall not be

rendered inoperative but the remaining provisions shall continue in full force and effect.

9. ENTIRE AGREEMENT. This Agreement is the entire agreement between AAS and the Licensee relating to the Software and: (i) supersedes all prior or contemporaneous oral or written communications, proposals and representations with respect to its subject matter; and (ii) prevails over any conflicting or additional terms of any quote, order, acknowledgement, or similar communication between the parties during the term of this Agreement except as otherwise expressly agreed by the parties. No modification to the Agreement will be binding, unless in writing and signed by a duly authorized representative of each party.
10. NON-WAIVER. No delay or failure to take any action or exercise any rights under this Agreement shall constitute a waiver or consent unless expressly waived or consented to in writing by a duly authorized representative of AAS. A waiver of any event does not apply to any other event, even if in relation to the same subject-matter.

Index

- about, 42
- architecture, 12
- audio, 43
 - configuration, 8, 43
 - device, 43
 - latency, 43
- auto-wah, 14, 25, 35

- backup, 17
- bank, 15
 - backup, 17
 - create, 15
 - delete, 15
 - factory library, 18
 - rename, 15
 - sharing, 17
- bank manager, 15
- buffer size, 8, 43

- character, 39
- chorus, 14, 25, 30
 - mono, 30
 - stereo, 30
- clock, 20
- coarse, 19
- compare, 41
- compressor, 14, 25, 27
- contact, 9
- cpu load, 40

- damper, 24
 - sustain pedal, 25
- default MIDI map, 44
- delay, 14, 25, 29
- distortion, 29, 42
- drop-down menus, 19

- edit view, 12, 20
- effect
 - synchronization, 20
- effect view, 14

- EQ, 26
- equalizer, 14, 25

- factory library, 8
- fine tuning, 19
- flanger, 14, 25, 31
- fork, 22
- fx view, 14, 25

- hammer, 20
 - force, 21
 - noise, 21
 - stiffness, 20
- help, 7, 9
- history, 10, 41

- installation, 7
- inteface
 - resize, 12
- interface, 19
 - drop-down menus, 19
 - knobs, 19
 - numerical displays, 19
 - switches, 19

- knobs, 19

- latency, 43
- level meter, 42
- lfo
 - synchronization, 20
- library
 - restore, 18
- limiter, 42

- manual, 42
- master volume, 42
- micro-tuning, 41
- MIDI, 43
 - bank change, 45
 - configuration, 8, 44

- device, 44
- link map, 44
- links, 44
- pitch bend, 39, 45
- program change, 15, 45
- receiving, 40
- MIDI controller, 44
- MIDI led, 40
- minimum system requirements, 6
- modulation, 19
- modulation wheel, 12, 40
- modules, 19
- multi-effect, 14, 25
 - auto wah, 35
 - chorus, 30
 - delay, 29
 - distortion, 29
 - EQ, 26
 - flanger, 31
 - notch filter, 36
 - phaser, 34
 - reverb, 37
 - synchronization, 20
 - wah wah, 35
- notch filter, 14, 25, 36
- numerical displays, 19
- overdrive, 29
- parameters, 19
- peak, 42
- phaser, 14, 25, 34
- pickup, 23
- pitch bend, 12, 45
- pitch wheel, 39
- play view, 12, 39
- plug-in, 9
 - audio configuration, 46
 - automation, 46
 - formats, 46
 - MIDI configuration, 46
 - MIDI program change, 46
 - multiple instances, 46
 - performance, 47
 - saving projects, 46
- polyphony, 7, 40
- programs, 8, 15
 - backup, 17
 - bank manager, 15
 - copy, 15
 - factory library, 18
 - move, 15
 - saving, 15
 - sharing, 17
- release, 24
- release time, 23
- resize, 12
- restore factory library, 18
- reverb, 14, 37
- ribbon, 12, 40
- sampling rate, 7, 8
- save, 15
- save as, 15
- sc, 27
- scala files, 41
- signal flow, 12
- solid state, 29
- standalone, 7
- start-up, 7
- sustain pedal, 24, 25
- switches, 19
- synchronization, 20
- system requirements, 6
- tine, 22
- tone, 22
- transpose, 41
- tremolo, 12, 25
- tuning, 41
- utility section, 40
- voices, 40
- volume, 42

VU meter, 42

wah wah, 14, 25, 35

warm tube, 29