



▶▶ NEUMANN.BERLIN

## ▶ KH 80 DSP

---

INSTRUCTION MANUAL





## Contents

<b>The KH 80 DSP studio monitor</b> .....	3
<b>Delivery includes</b> .....	3
<b>About this manual</b> .....	3
<b>Product overview</b> .....	4
<b>Installing and connecting the KH 80 DSP</b> .....	5
Preparing the loudspeakers .....	5
Preparing the room .....	5
Positioning the loudspeakers .....	6
Connecting audio signals .....	7
Connecting network cables .....	8
Connecting/disconnecting the KH 80 DSP to/from the mains power supply .....	8
<b>Configuring and using the KH 80 DSP</b> .....	9
Switching the KH 80 DSP on/off .....	9
Functionality of the Neumann logo .....	10
SETTINGS switch .....	11
Resetting the KH 80 DSP .....	11
Firmware update .....	11
Adjusting the frequency response using the backpanel controls .....	12
Adjusting the acoustic level .....	12
Configuring standby .....	13
Adjusting standby behaviour .....	13
<b>Cleaning and maintaining the KH 80 DSP</b> .....	15
<b>Troubleshooting</b> .....	15
<b>Specifications</b> .....	15
<b>Acoustical measurements and block diagram</b> .....	16
<b>Accessories</b> .....	16
<b>Installation angles</b> .....	17



## The KH 80 DSP studio monitor

Thank you for purchasing a Neumann studio monitor. The KH 80 DSP features a Mathematically Modeled Dispersion™ Waveguide (MMD™), DSP acoustical controls, control via an IP network and an extensive range of mounting hardware. This allows the loudspeaker to be used in diverse acoustical conditions, with any source equipment and in a wide variety of physical locations. The KH 80 DSP represents the latest in acoustic and electronic simulation and measurement technologies to ensure the most accurate sound reproduction possible.

Depending on the size, Neumann's two-way loudspeaker systems are designed for use as near field monitors or as rear loudspeakers in larger multi-channel systems. They can be used in project, music, broadcast, and post production studios for tracking, mixing, and mastering.

### Delivery includes

- 1 KH 80 DSP
- 4 Self-adhesive feet
- 1 Safety Guide
- 1 Supplement "Getting Started Quickly"

Delivery also includes European, UK or US mains cables

### About this manual

This operating manual describes the physical setup and autonomous operation of the KH 80 DSP. For information about using the KH 80 DSP in a network with the Neumann.Control iPad® App please refer to the app.

Some of the advantages of exploring Neumann.Control are:

- More extensive acoustical controls for more accurate audio reproduction
- System-wide control such as volume control, soloing and muting
- Rapid system re-purposing

To download the app go to the Apple App Store and search for "Neumann.Control".





## Product overview

Front panel

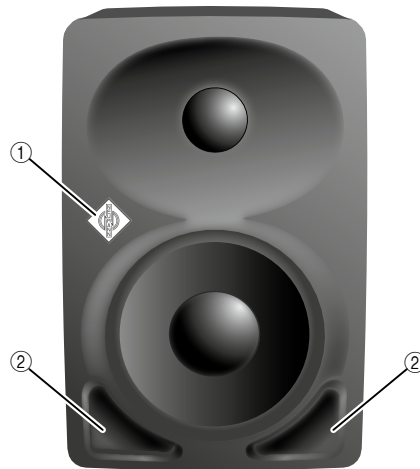

- ① Neumann logo
  - for information on the functionality of the Neumann logo refer to chapter “Functionality of the Neumann logo”
- ② Bass reflex ports

Back panel

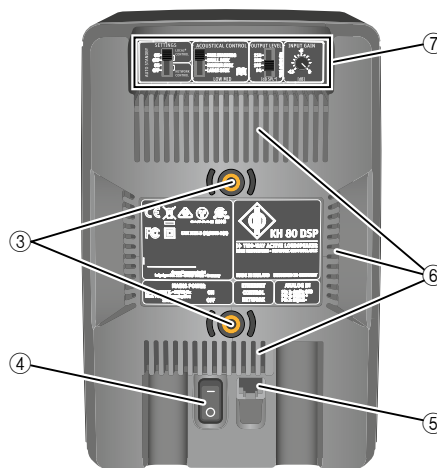

- ③ Threaded inserts (M6) for Neumann mounting hardware
- ④ On/off switch
- ⑤ RJ-45 socket for network control
- ⑥ Cooling vents
- ⑦ Control switches

Bottom

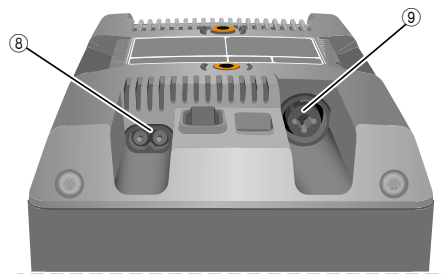

- ⑧ Mains socket
- ⑨ XLR/jack analog input socket



## Installing and connecting the KH 80 DSP



### CAUTION

Danger of injury and material damage due to tipping/dropping of the product!

If improperly mounted, the product and/or the mounting hardware (e.g. rack) can tip over or drop down.

- ▶ Always have the product mounted by a qualified specialist according to local, national and international regulations and standards.
- ▶ Use the mounting systems recommended by Neumann and always provide sufficient additional protection against tipping or dropping.

### CAUTION

Damage to the product due to overheating!

If air cannot circulate properly around the cooling vents on the rear of the product, the amplifier(s) may overheat leading to premature activation of the thermal protection system which limits the maximum output level of the loudspeaker. In rare cases, damage to the product may also occur.

- ▶ Never cover the cooling vents.
- ▶ When installing the product into tight spaces such as wall recesses, maintain an air gap of at least 5 cm (2") around the top, rear and side panels of the product and provide sufficient air circulation. If necessary, use forced-air cooling (e.g. in OB vans).



For information on installation, please refer to the supplied "Getting Started Quickly" supplement. This will help you set up the loudspeakers in a way that will give you the best acoustic performance from the system.

For further information on setting up loudspeakers, please refer to the "Questions & Answers" section on the product page at [www.neumann.com](http://www.neumann.com).

For more information on building systems using Neumann loudspeaker products, please refer to the Product Selection Guide at [www.neumann.com](http://www.neumann.com)

## Preparing the loudspeakers

### CAUTION

Risk of staining surfaces!

Some surfaces treated with varnish, polish or synthetics may suffer from stains when they come into contact with other synthetics. Despite a thorough testing of the synthetics used by us, we cannot rule out the possibility of staining.

- ▶ Do not place the loudspeaker on delicate surfaces.

To place the loudspeaker on a flat surface:

- ▶ Attach the supplied self-adhesive feet to the bottom of the cabinet.

This reduces the risk of scratching the surface and acoustically isolates the loudspeaker from the surface.

## Preparing the room

- ▶ Arrange all acoustically relevant surfaces and objects symmetrically on either side of the listening axis of the room (left/right).
- ▶ Minimize the sound that is reflected back to the listening position by using angled surfaces and/or acoustical treatment.



This product has been optimized for use in recording studios. In order not to affect the quality of reproduction, make sure that the product is used in an EMC (electromagnetically compatible) environment.



## Positioning the loudspeakers

- Carry out the following steps very accurately, since the more accurate the physical arrangement of the loudspeakers in the room, the more accurate the reproduction will be at the listening position.

- Distances**
- Observe the recommended distances between the loudspeakers and your listening position (imperial dimensions are approximate):
    - Minimum: 0.50 m (2')
    - Recommended: 0.8–1.75 m (2'6"–6')
    - Maximum: 3.0 m (9')

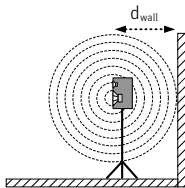

- Avoid positioning the loudspeaker at a distance “ $d_{wall}$ ” of 0.8 to 1.75 m (2'6"–6') from the wall behind the loudspeaker. When positioning bass managed loudspeakers, avoid a distance “ $d_{wall}$ ” of 0.8 to 1 m (2'6"–3') from a solid wall behind the loudspeaker. Similarly, avoid these distances from solid side walls or a solid ceiling. Respecting these positioning limitations reduces the chances of dips in the low frequency response (comb filtering) caused by strong reflections.

### Arranging the loudspeakers at an angle

- Print out the diagram “Installation angles” that can be found at the end of this operating manual.
- Place the diagram at the listening position or center of the listening area.
- Using a tape measure, place the loudspeakers at the same distance from the center of the diagram “Installation angles”. To ensure good imaging, do this at an accuracy of at least 1 cm ( $\frac{1}{2}$ ").
- If the loudspeakers cannot be placed at the same distance from the listening position, compensate for distance differences  $> 1$  cm ( $\frac{1}{2}$ " ) by delaying closer loudspeakers by 30  $\mu$ s/cm (76  $\mu$ s/inch). Delay can be set directly in the loudspeaker using the Neumann.Control iPad® App.
- Check the location of the loudspeaker cabinet. This depends on the application:
  - 2.0 systems (stereo):  $\pm 30^\circ$ , plus optional subwoofer(s)
  - 5.1 systems:
    - ITU-R BS.775-1:  $0^\circ, \pm 30^\circ, \pm 110^\circ (\pm 10^\circ)$ , plus optional subwoofer(s) (center, front left/right, surround left/right)
    - ANSI/SMPTE 202M:  $0^\circ, \pm 22.5^\circ$ , arrays to the surround left and to the surround right, plus optional subwoofer(s)
  - 7.1 systems:  $0^\circ, \pm 30^\circ, \pm 90^\circ, \pm 150^\circ$ , plus optional subwoofer(s) (center, front left/right, side left/right, back left/right)
  - 3D systems: See the recommendations from Dolby, DTS, Auro3D and ITU-R BS.2051-0 for loudspeaker positioning.

The acoustical axis of the KH 80 DSP is located at the midpoint of the bass and tweeter drivers.

- Always point the acoustical axis, in the horizontal and vertical planes, towards the listening position.

**i** The acoustical axis is a line perpendicular to the loudspeaker’s front panel along which the microphone was placed when tuning the loudspeaker’s crossover during design. Pointing the acoustical axis, in the horizontal and vertical planes, towards the listening position or center of the monitoring area will give the best measured and perceived sound quality.

- Position the loudspeaker so that there is a direct line of sight from the listening position to the bass and tweeter drivers.

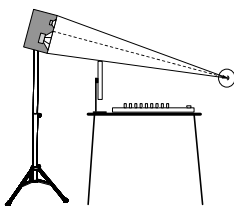
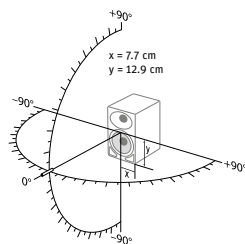



## Connecting audio signals

- ▶ Always use good quality cables to achieve the maximum cable lengths shown below:

Signal (connector)	Cable length	Connection
Analog (XLR)	up to 100 m (300')	directly to the ANALOG INPUT socket (XLR/Jack) (see below)
Analog (Jack)	up to 100 m (300')	directly to the ANALOG INPUT socket (XLR/Jack) (see below)
Analog (RCA)	up to 10 m (30')	via an adapter (RCA-XLR or Jack-XLR) to the ANALOG INPUT socket (XLR/Jack) (see below)

If possible, use a balanced connection (XLR, stereo Jack) in order to avoid interference in the cable.

### Connecting analog signals to the KH 80 DSP

Connecting XLR, Jack or RCA cables

- ▶ Only connect analog signals to the KH 80 DSP.
- ▶ Connect the left and right output of your analog audio source to the XLR input sockets of the respective loudspeaker.

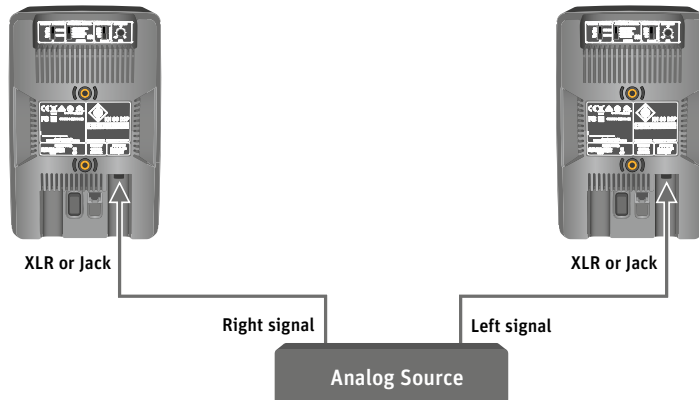

- ▶ Use an XLR or Jack adapter (not supplied) to connect unbalanced cables (e.g. RCA cables).
- ▶ Use this adapter directly at the source and connect the adapter via a properly wired balanced XLR cable to the loudspeaker. The connection of pin 3 to ground should be as close as possible to the source to maximize hum rejection on the cable.
- ▶ Use the following wiring if you want to make your own RCA to XLR cable:

Wiring	Pin	Signal
<p>Unbalanced RCA to balanced XLR connections</p>	1	Audio ground
	2	Signal +
	3	Signal -



## Connecting network cables

To use the extended functionality offered by the Neumann.Control iPad® App, the loudspeaker must be connected to a standard network switch using a user supplied standard Ethernet cable (Cat 5 or better). The maximum length of the cable is 100 m.

Refer to the Neumann.Control iPad® App for information about how to use loudspeakers in a network.

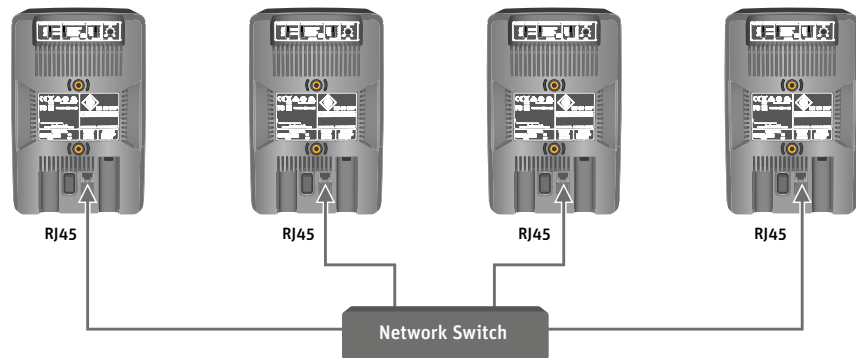

## Connecting/disconnecting the KH 80 DSP to/from the mains power supply

To connect the KH 80 DSP to the mains power supply:

- ▶ Make sure that the on/off switch is set to “OFF”.
- ▶ Connect the figure-8 connector of the supplied mains cable to the mains socket.

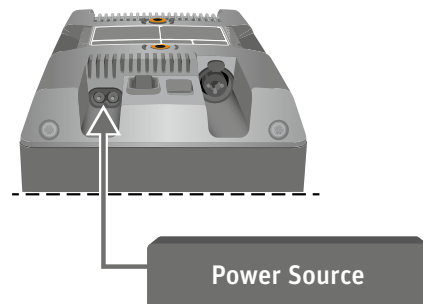

- ▶ Connect the mains plug of the mains cable to a suitable wall socket.

To disconnect the KH 80 DSP from the mains power supply:

- ▶ Set the on/off switch to “OFF”.
- ▶ Pull the mains plug out of the wall socket.





## Configuring and using the KH 80 DSP

### Switching the KH 80 DSP on/off

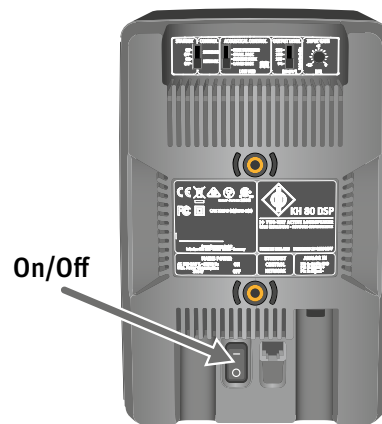

▶ Set the on/off switch to:

- “ON” to switch on the loudspeaker. The Neumann logo lights up solid red while the DSP system boots up. After approximately 5 seconds it turns white indicating the loudspeaker is ready to be used. If the logo brightness has been set to less than 100% in the Neumann.Control iPad® App, it will be dimmed or off after the bootup phase is complete.
- “OFF” to switch off the loudspeaker. The Neumann logo switches to red for a short moment and then goes off.



There is a five second delay before sound can be heard from the loudspeaker in order to avoid noises (pops) from preceding equipment switched on at the same time. Conversely, switching off the loudspeaker immediately mutes the audio.



## Functionality of the Neumann logo

Action	Logo indication
<b>Firmware activities</b>	
Loudspeaker is booting up	Solid red
Loudspeaker boot up error	Fast red flashing
Loudspeaker firmware is being updated	Solid rosé
Loudspeaker resetting to factory default settings	Rosé flutter flash
<b>Everyday operation</b>	
Operating normally (dimnable via Neumann.Control)	Solid white
Loudspeaker in active system is solo'ed in Neumann.Control	Solid white
Loudspeaker system output level is dimmed or muted (GUI button on Operate page)	Solid rosé
Neumann.Control is saving changes to the loudspeaker's memory (not Operate page commands)	Solid rosé
<b>Protection and Standby</b>	
Protection system is activated (takes priority over other indications)	Red
<b>Neumann.Control Alignment</b>	
Setup: Identify the loudspeaker	Rosé pulses (2 Hz) + audible ID tone
Guided Alignment: Loudspeaker is selected	Rosé pulses (0.5 Hz)
Manual Alignment: Loudspeaker is selected	Solid rosé



## SETTINGS switch

The SETTINGS switch has two functions which can be turned on or off independently.

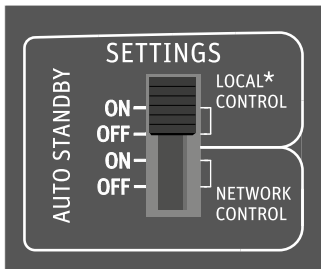

### STANDBY

If the SETTINGS switch has been set to one of the two AUTO STANDBY = ON positions, the KH 80 DSP will switch to standby after 90 minutes.

Standby means that the network interface, signal processing circuitry and power amplifiers are all powered down. Standby mode is automatically deactivated when a sufficiently large audio signal is detected at the analog input. The time taken to resume normal operation and hear sound is 5 seconds. It is possible to change the time before standby mode is activated using the Neumann.Control iPad® App.

Standby can be disabled by moving the SETTINGS switch to one of the two AUTO STANDBY = OFF positions.

 For detailed information on standby please refer to chapter “Configuring standby” on page 13.

### CONTROL

If the SETTINGS switch has been set to one of the two LOCAL CONTROL positions, the KH 80 DSP will not react to network commands. Control of the loudspeaker will be from the backplate only.

If the SETTINGS switch has been set to one of the two NETWORK CONTROL positions, the KH 80 DSP will react to network commands from the Neumann.Control iPad® App. The other backplate controls will be ignored.

If the SETTINGS switch is set to NETWORK CONTROL but there is no network connection and active Neumann.Control iPad® App, the last used network configuration will be used.

If you have configured any settings via the Neumann.Control iPad® App and you remove the network cable, the current settings will stay active.

By switching from network control to local control you can easily switch between a configuration measured in the Neumann.Control iPad® App and settings made directly on the loudspeaker.

This can make sense if you want to temporarily use the loudspeaker in a different location than your measured studio environment.

The loudspeaker does not lose its settings even when disconnecting it from the network or the mains supply.

## Resetting the KH 80 DSP

To reset the KH 80 DSP internal controls to their factory default values:

- Switch on the KH 80 DSP.
- While the Logo is still red indicating the boot up phase, move the SETTINGS switch up and down repeatedly. Keep doing this until a few seconds after the logo turns white. The Logo will then light up with a red flutter flash for a few seconds before reverting to white.

## Firmware update

Firmware updates are done via the Neumann.Control iPad® App. When it is opened it surveys the network for loudspeakers and checks if the firmware is up to date. If a firmware update is needed, you will be prompted to follow the on-screen instructions. It takes approximately 10 seconds per loudspeaker to do the update.



## Adjusting the frequency response using the backpanel controls

When the LOW MID control is set to FREE STANDING or, via the Neumann.Control iPad® App, the acoustical controls have been set to 0 dB, the KH 80 DSP loudspeaker is designed to have a flat frequency response in anechoic conditions. When the loudspeaker is installed in your monitoring environment, the response changes. The same loudspeaker installed in different positions in the same room may require different acoustical control settings. In a symmetrical installation, left/right pairs (front or back) will probably have the same acoustical settings.

- ▶ Before using your loudspeaker system for the first time, align the frequency response of the loudspeakers in the room in order to obtain the desired response.
- ▶ Repeat the above step if you change the physical conditions in your studio.
- ▶ At your listening position, determine the frequency response of each loudspeaker.
- ▶ Use the ACOUSTICAL CONTROL switch to compensate for the acoustical loading in the low-mid frequency range due to nearby large solid objects (e.g. mixing consoles, desks or computer screens).



ACOUSTICAL CONTROL switch	Possible settings
Low-Mid	Free Standing (0 dB), Small Desk (-1.5 dB), Medium Desk (-3 dB), Large Desk (-4.5 dB)

## Adjusting the acoustic level

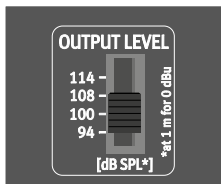
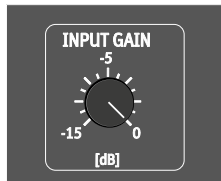

- ▶ On your KH 80 DSP loudspeakers, set the OUTPUT LEVEL switch to 94 dB SPL and the INPUT GAIN control to -15 dB.
- ▶ Play a broadband pink noise test signal that is set to -18 dBFS (Europe) or -20 dBFS (USA) on the mixing console's output level meters.
- ▶ Measure the sound pressure level at the listening position using a sound level meter with the following settings:
  - "C"-weighted
  - slow integration time
- ▶ Set the OUTPUT LEVEL switch and INPUT GAIN control of your loudspeakers so that the desired acoustic level is obtained.

Recommended sound pressure levels:

Application	Sound pressure level
Film	85 dB(C)
Broadcast	79 to 83 dB(C)
Music	No defined reference levels

If the Neumann logo flashes red, the loudspeaker's protection system has been activated. To avoid this and achieve the desired output level, use larger loudspeakers or add a bass managed subwoofer to the system.

Examples of sound pressure levels as a function of the input and output level of the KH 80 DSP:

Input signal dBu	0 (0.775 V)	0 (0.775 V)	+4 (1.23 V)	-20 (77.5 mV)
INPUT GAIN control dB	0	-15	-4	-15
OUTPUT LEVEL switch dB SPL	100	100	94	114
Sound pressure level dB SPL at 1 m	100	85	94	79

## Configuring standby

The KH 80 DSP will switch to standby depending on the applied input level, standby time, output gain level settings and the position of the SETTINGS switch.

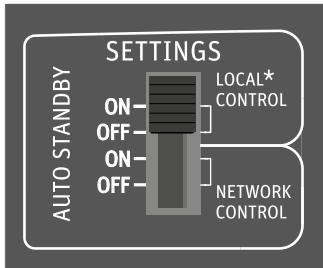

### Standby settings in backplate mode

- ▶ Set the SETTINGS switch to LOCAL CONTROL - AUTO STANDBY = ON.

The standby time is set to 90 minutes.

The output level depends on the OUTPUT LEVEL switch and INPUT GAIN control settings on the back of the loudspeaker. Adjust these according to your setup.

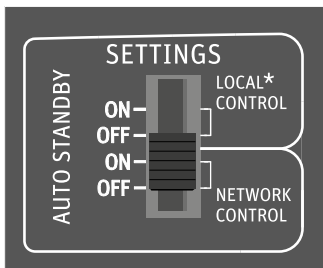

### Standby settings in network mode

- ▶ Set the SETTINGS switch to NETWORK CONTROL - AUTO STANDBY = ON.

The following values can be configured individually using the Neumann.Control iPad® App:

- standby time
- threshold below which the KH 80 DSP will switch to standby
- output level

## Adjusting standby behaviour

### Standby is too sensitive

When standby is too sensitive, the KH 80 DSP does not switch to standby when it is supposed to or it wakes up from standby when it is not supposed to.

Possible reasons:

The source might have some noise or spikes which wake up the loudspeaker or prevent it from switching to standby. This might also lead to various KH 80 DSP behaving differently while using the same settings.

Observe the following steps to find out if there is any noise or spikes which could lead to randomly waking up the loudspeakers:

- ▶ Switch the auto standby function off by setting the SETTINGS switch to the OFF position of the LOCAL CONTROL section.
- ▶ Set the OUTPUT LEVEL switch to 114 dB in order to be able to hear any disturbing signal.
- ▶ Listen closely if you hear any spikes.
- ▶ Alternatively, record the loudspeaker output with a microphone and analyse the recording.
- ▶ Try to identify if there is any correlation to anything switching on and off in the house (e. g. refrigerator, etc.)

You can test if standby works correctly by connecting a short XLR cable to the input of the loudspeaker with no device connected to the other end of the cable.

- ▶ In backplate mode, set the OUTPUT LEVEL switch to 100 dB. The loudspeaker should switch to standby after 90 minutes.
- ▶ In network mode, set the standby time to a desired value and set the standby level to 30 dB via the Neumann.Control iPad® App.
- ▶ Set the SETTINGS switch to NETWORK CONTROL - AUTO STANDBY = ON. The loudspeaker should switch to standby after the time you set.

 Since the loudspeaker continuously watches the input signal, even spikes which are coming from the source or are induced into the cable could prevent the loudspeaker from switching to standby. Ensure that no signal spike from the source or spikes induced into the cabling can wake the loudspeaker up.

### Standby is too insensitive

When standby is too insensitive, the KH 80 DSP switches to standby when it is not supposed to or does not wake up from standby when it is supposed to.

Possible reasons:

The standby threshold level is above the signal level. When the input and output levels of the KH 80 DSP are set very low but the source has a very high level, this leads to a very low audible output signal.

- ▶ In backplate mode, increase the output level of the source or the input and output levels of the KH 80 DSP in order to increase the sound pressure level above the standby threshold.
- ▶ In network mode, increase the output level of the source or the input and output levels of the KH 80 DSP in order to increase the sound pressure level above the standby threshold.
  - Set the standby time to the desired time (for test purposes you can set it to a shorter time) via the Neumann.Control iPad® App
  - Set the standby level to a lower level (e. g. 17 dB) via the Neumann.Control iPad® App.
  - Set the SETTINGS switch on the back of the KH 80 DSP to NETWORK CONTROL - AUTO STANDBY = ON

In general, you should keep the gain settings of the loudspeaker as low as possible (e. g. INPUT GAIN control - 0, OUTPUT LEVEL switch 94 or 100 dB SPL) and the level of your source as high as possible to get the best signal to noise ratio and keep induced disturbances as low as possible.

The wakeup signal depends on the level which is connected to pin 2 of the XLR (Tip of the TRS jack) connector. If an unbalanced signal is connected to pin 3 of the XLR connector (ring of the TRS jack), the signal cannot be detected. In this case the signal is also inverted in phase.

Ideally, the source should be connected to the loudspeaker via a balanced XLR to XLR or XLR to TRS jack cable. If there is only an unbalanced source available, the connection should be done according to the following diagrams.

#### Mini jack (3.5 mm) or jack (6.3 mm) headphone output of a television or hi-fi system:

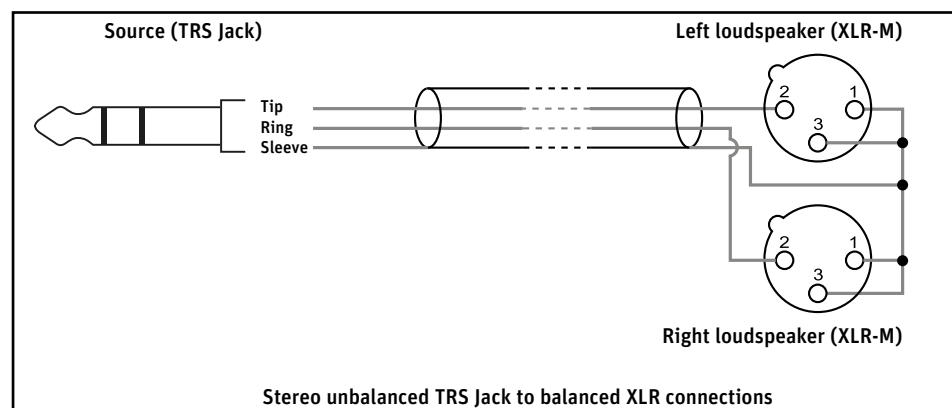

#### RCA line outputs of a television (if level is adjustable) or RCA pre-amp outputs of an AV receiver (one cable is required for each loudspeaker):

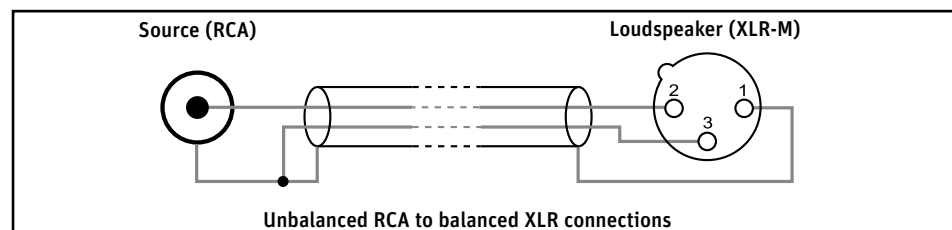

We recommend performing a reset of the KH 80 DSP (see “Resetting the KH 80 DSP” on page 11) to make sure there are no unreasonable values set. After that, create a new system with the Neumann.Control iPad® App to prevent original values from being transferred to the loudspeakers again.



## Cleaning and maintaining the KH 80 DSP

### CAUTION

Damage to the product caused by liquids!

Liquids entering the product can cause a short-circuit in the electronics and damage or even destroy the product.

▶ Keep all liquids away from the product!

- ▶ Before cleaning, disconnect the product from the mains power supply.
- ▶ Use a soft, dry, and lint-free cloth to clean the product.

## Troubleshooting

Problem	Cause	Solution
The Neumann logo is off, no sound is heard from the KH 80 DSP	The KH 80 DSP main fuse has blown.	Have the product checked by an authorized Neumann service partner.
The Neumann logo is off or not clearly visible, but sound is heard from the KH 80 DSP	The Neumann logo is switched off or dimmed.	Switch on the Neumann logo and switch off the dimming (see page 9) .
The KH 80 DSP is humming	Incorrect wiring in the audio cable and/or poor quality grounding in the audio cable.	Check the cabling, especially if unbalanced cabling has been used - see the cable wiring diagram on page 7. Use gold plated connectors. Set the output level of the KH 80 DSP as low as possible and set the output level of the audio source as high as possible, without causing it to clip.
The loudspeaker sounds very “thin” in the bass. The low frequency response is very low.	Incorrect wiring in the audio cable or adapter.	Check the cabling, especially if unbalanced cabling has been used - see the cable wiring diagram on page 7.
Standby is too sensitive or too insensitive	Incorrect standby settings or spikes and noise from the source.	Check the standby settings and the source signal - see “Adjusting standby behaviour” on page 13.

For further information, please refer to the “Questions & Answers” section on the product page at [www.neumann.com](http://www.neumann.com).

## Specifications

For a complete list of the product specifications please refer to the product page of the KH 80 DSP at [www.neumann.com](http://www.neumann.com).

Product properties	
Power supply	100 to 240 V~, 50/60 Hz
Power consumption (230 V / 100 V)	Standby <330 mW / <50 mW Idle 9 W / 8 W Full output 180 W
Dimensions (H x W x D)	233 x 154 x 194 mm (9 1/8" x 6" x 7 5/8")
Weight	3.4 kg (7 lbs 8 oz)
Temperature	
Operation and storage, unpacked	+10 °C to +40 °C (+50 °F to +104 °F)
Transport and storage, packed in original packaging	-25 °C to +60 °C (-13 °F to +140 °F)
Relative humidity	
Operation and storage, unpacked	max. 75 % (non-condensing)
Transport and storage, packed in original packaging	max. 90 % (non-condensing)



## Acoustical measurements and block diagram

Additional technical data such as acoustical measurements and a block diagram can be found on the product page of the KH 80 DSP at [www.neumann.com](http://www.neumann.com).

## Accessories

Product	Description
LH 28	Tripod stand adapter
LH 29	TV spigot (lighting stand adapter)
LH 32	Wall L-bracket
LH 37	Subwoofer adapter
LH 43	Surface mounting plate
LH 45	Wall bracket
LH 46	Adjustable ceiling drop adapter
LH 47	Mounting adapter plate
LH 48	Tripod adapter plate
LH 61	Adjustable L-bracket
LH 64	Omnimount/VESA adapter
LH 65	Table stand





## Installation angles

