



# Large-Flat Series Cinema Screen Perm-Fix Model

www.cyberscreens.co.uk - sales@cyberscreens.co.uk  
T: 01438 311625 - F: 01438 311626  
Unit 7 Arlington Business Park, Whittle Way  
Stevenage SG1 2BE



ISO-9001-2000  
International certification



- Simple yet elegant frame fabricated from high quality aluminum alloy
- Projection surface utilizes the Grandview PS series flexible screen with mini-type and fine diamonds that work effectively to remove purple light and light waves as well as fully reverting color. This preserves contrast, image details and reduces glare. Project surface back-side utilizes special gray-scale PVC composite material. This special material filters excess light to preserve the image-presenting quality of the projection surface. The frame structure ensures a flat surface.

## Product Features

- The simple yet elegant frame is made from high quality aluminum alloy
- Surface structure's design ensures that the display area is stable and prevents the formation of v-wave wrinkles at the center of the screen's surface
- The projection surface utilizes the Grandview PS series flexible screen with mini-type diamond veins that removes purple-light and fully reverts color. This material preserves contrast, image details and reduces glare while also presenting a clear picture at any angle.
- The projection surface's backside utilizes a special gray-scale PVC composite material. This special material filters excess light to preserve the image-presenting quality of the projection surface. With a viewing angle of 140 degrees and gain factor of 2.2, the flexible material ensures vivid pictures and a flexible, flat surface. With Grandview's Large-Flat series screens, viewers can have a movie theatre experience right at home.
- Two sliding hooks positioned behind the projection screen allow for easy installation for a hanging wall display.
- Suitable for use in home theaters, conference areas, outdoor recreational settings, and etc.

## Large-Flat Perm-Fix Product Features

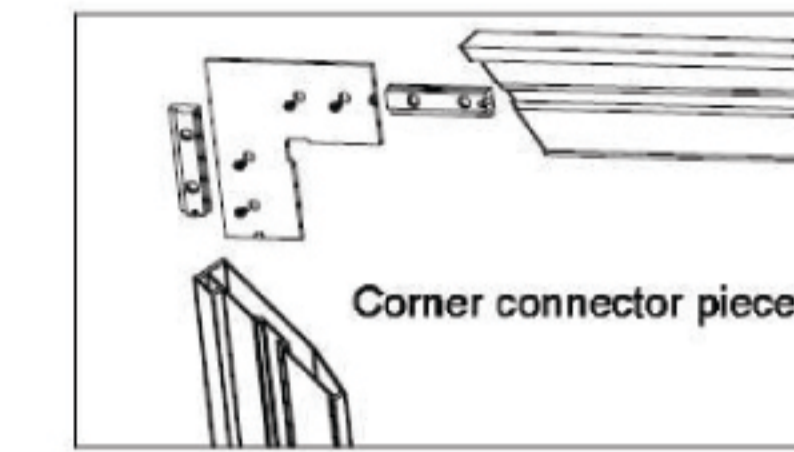

Corner connector pieces connect the outside of the frame

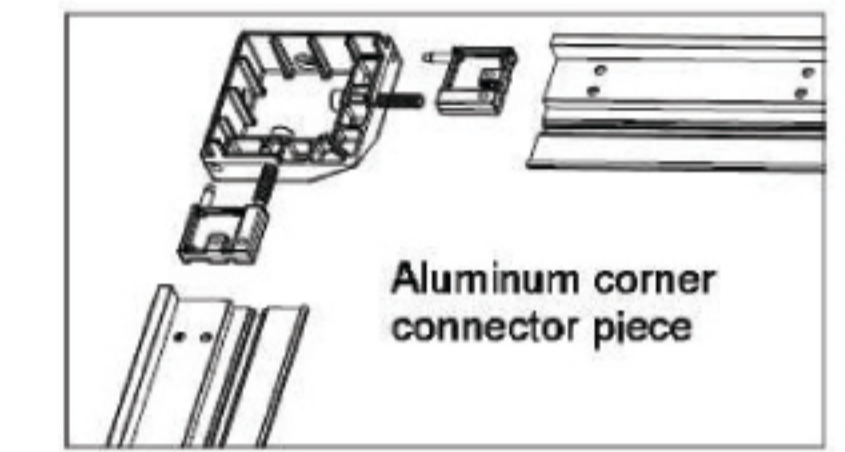

Aluminum corner connector pieces connect the outside of the frame

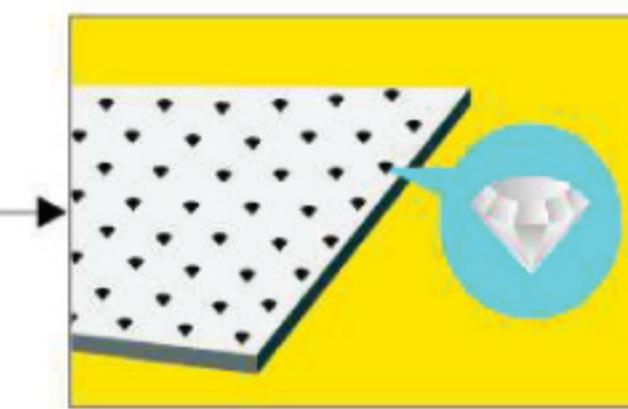

Grandview PS Series flexible material



Installation hooks allow for a convenient and easy setup

## Large-Flat Cinema Screen Perm-Fix Model (optional front and rear projection screen fabrics)

Grandview PS Series flexible screen



The view angle of PS Series Flexible screen: 100

The gain of PS series Flexible screen

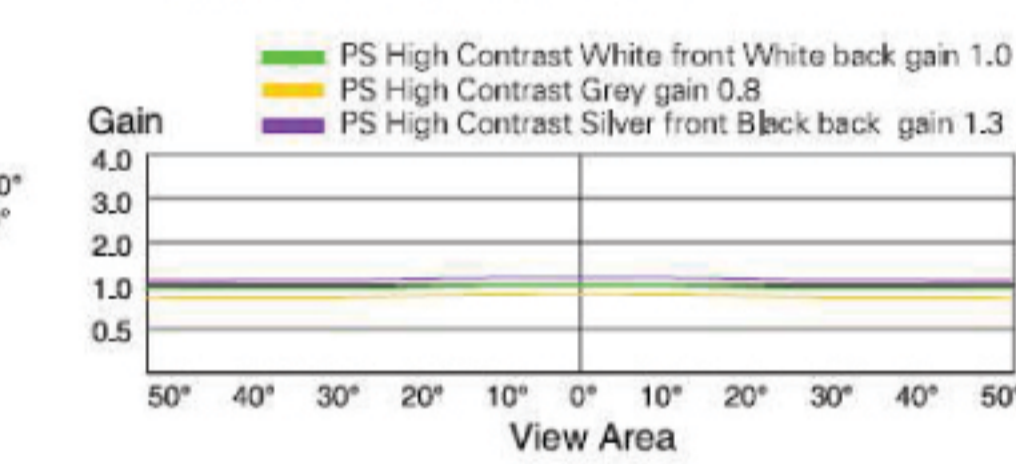

PS Series flexible screen

- Washable
- Flame retardant
- Mildew resistant
- View Area 100°
- Gain 1.0
- Environment Protection

Grandview PS Series Flexible Rear screen



The view angle of PS Series Flexible Rear screen: 140

The gain of PS series Flexible Screen: 2.2

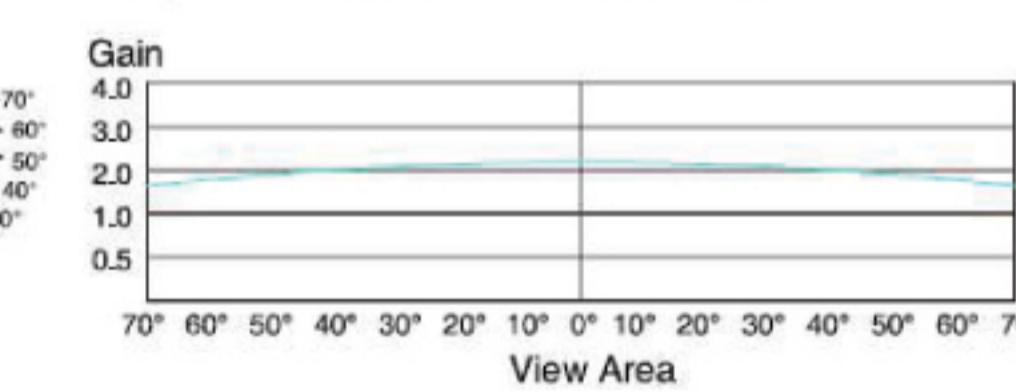

PS Series Flexible Rear screen

- Washable
- Flame retardant
- Mildew resistant
- View Area 140°
- Gain 2.2
- Environment Protection

## Product Safety

- When installing, make sure it is facing forward. the back of the screen will be labeled with a sticker.
- Please read the following as any damage to the screen surface will affect the quality of the picture:
  - 1.The frame is made with lightweight aluminum. Please handle with care.
  - 2.Avoid contact or touching the screen surface as it may cause scratches or tears.
  - 3.Do not write or draw on the surface.
  - 4.Clean the screen with a soft cloth and lukewarm water. Do not use any detergent or cleaning products.
  - 5.Use a cotton cloth to carefully wipe off the dust on the frame to prevent any damages
  - 6.If it is not in use for a long period of time, cover the screen to shut out dust and dirt.
- To prevent unnecessary damage, the operating and maintenance of the screen should be done by adults.

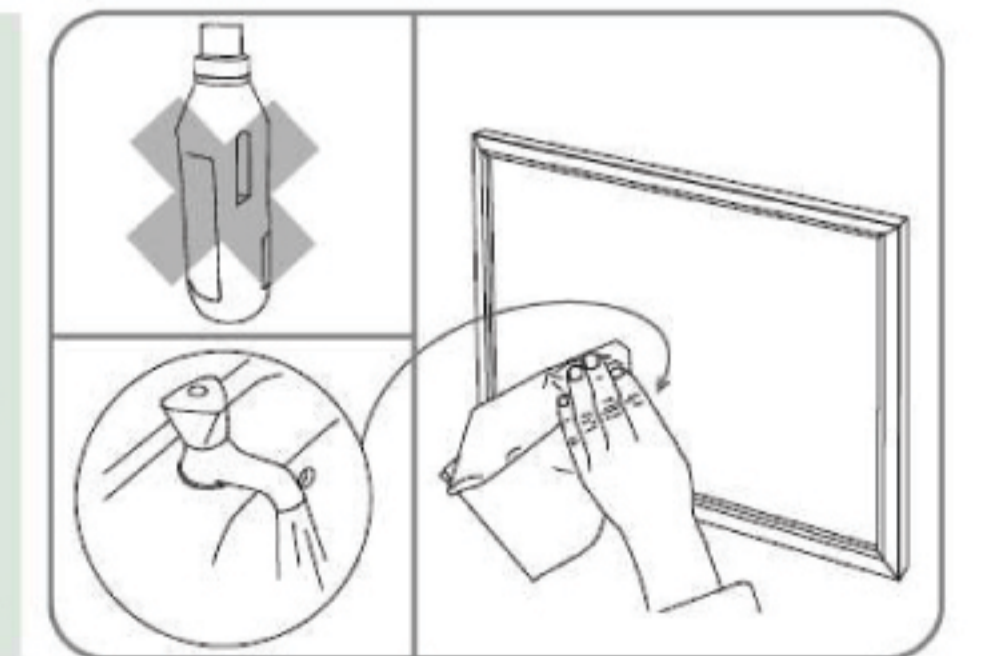

## Warnings



Ignoring the safety warnings may lead to injuries and/or damaging the product.



Fixtures should be installed in a secure place to avoid accidents or the screen falling.



Please contact your local dealer for repairs or maintenance. Please contact our company if you have any further questions. Avoid taking apart the fixtures yourself. Loose parts may cause the screen to fall.



Refrain from hanging anything on the screen as it may cause the screen to fall.

Attractive alloy/velvet frame

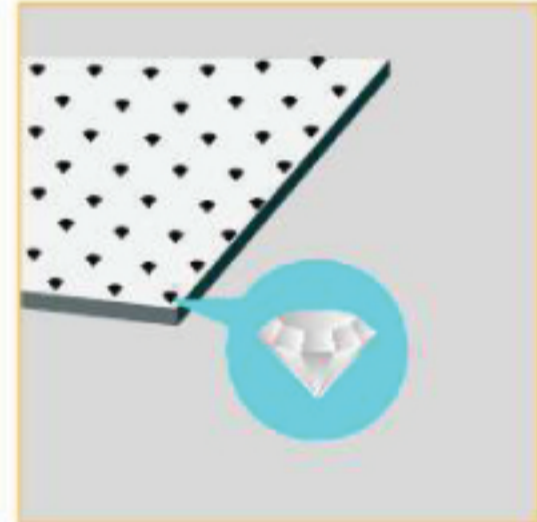

PS Series flexible screen that effectively removes light-waves

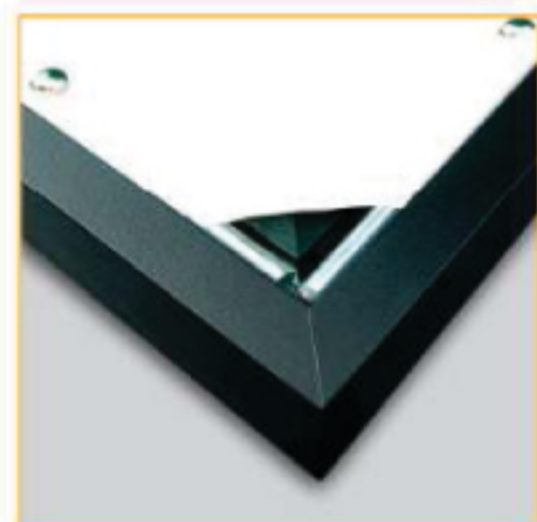

The structure ensures balanced pulling pressure on all sides



Versatile and convenient adjustable mounting bracket



# SPECIFICATIONS

## Prestige Model Sizes and Specifications

### Format 16:9

Specification(in)	77	92	106
Viewing Area W	mm 1704	2037	2346
	in 67-3/32	80-3/16	92-3/8
Viewing Area H	mm 958	1145	1319
	in 37-23/32	45-1/16	51-15/16
L total length	mm 1826	2159	2468
	in 71-7/8	85	97-5/32
A size	mm 1080	1267	1441
	in 42-17/32	49-7/8	56-23/32
C size	mm 400	500	600
	in 15-3/4	19-11/16	23-5/8
Net Weight (kg)	7.9	9.3	10.7

## Perm-Fix Cinema Screen Package Specifications

### Prestige Model

Format	4:3		16:9	
	Packaging LxWxH		Packaging LxWxH	
Specification	mm	in	mm	in
77	1853x250x155	72-15/16x9-27/32x6-3/32	1955x250x155	78-17/32x9-27/32x6-3/32
92	2157x250x155	84-29/32x9-27/32x6-3/32	2325x250x155	91-17/32x9-27/32x6-3/32
106	2442x250x155	96-1/8x9-27/32x6-3/32	2634x250x155	103-11/16x9-27/32x6-3/32

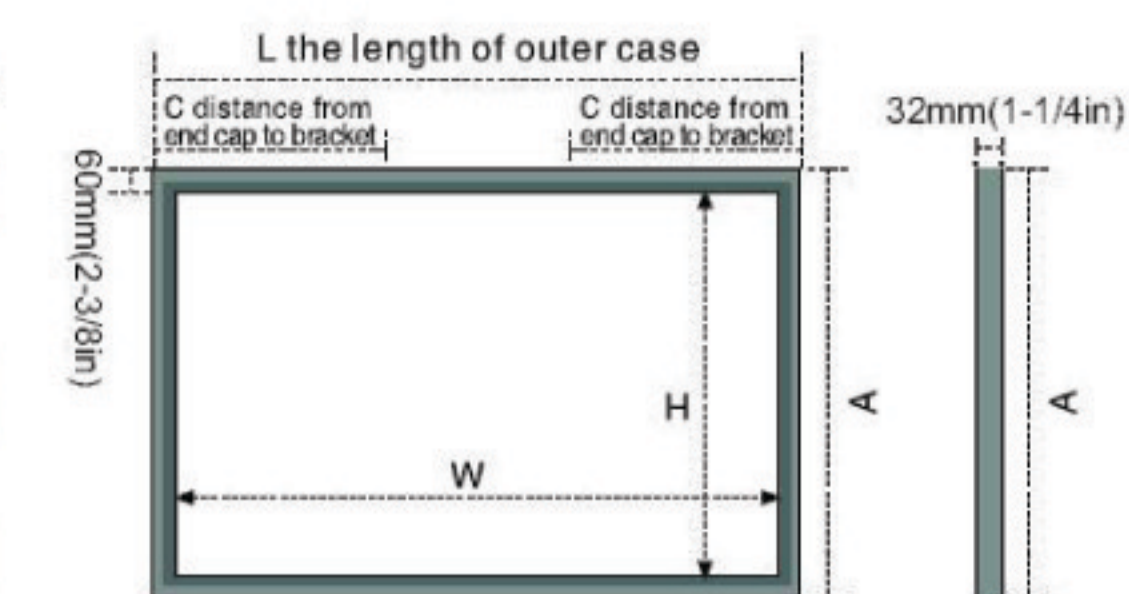

Signature Model

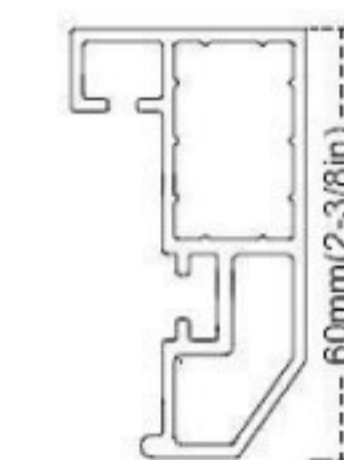

Signature Model corner connector piece side view

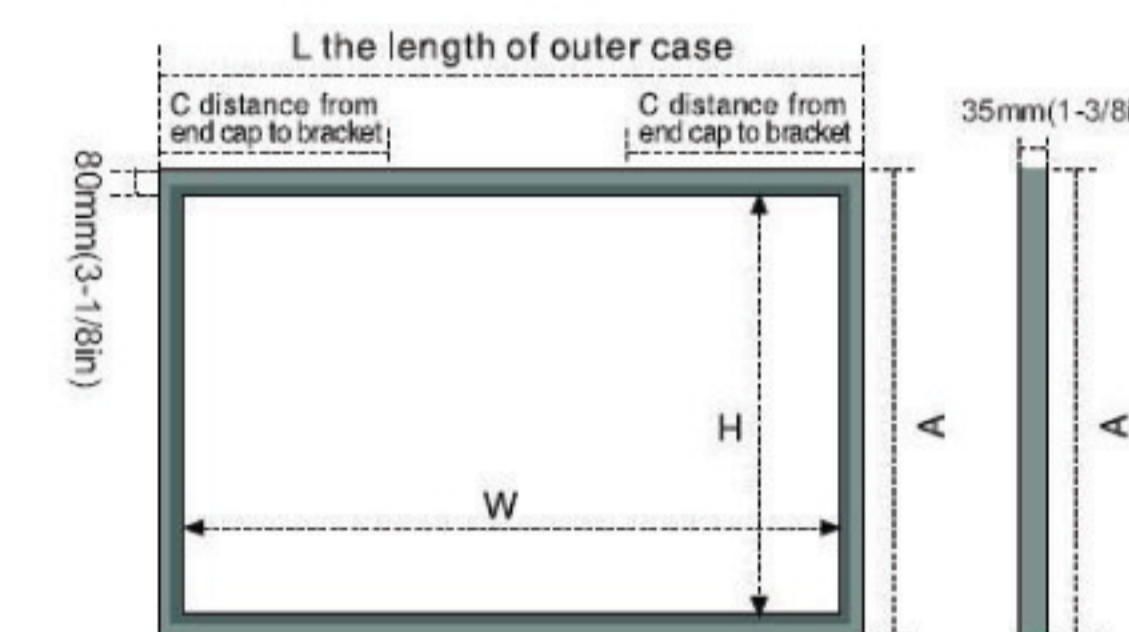

Prestige Model

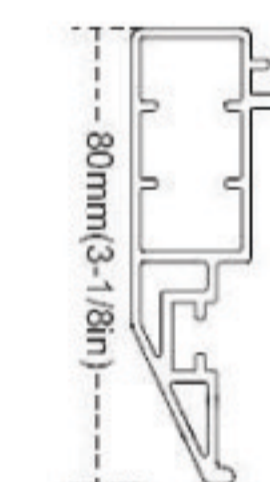

Prestige Model corner connector piece side view

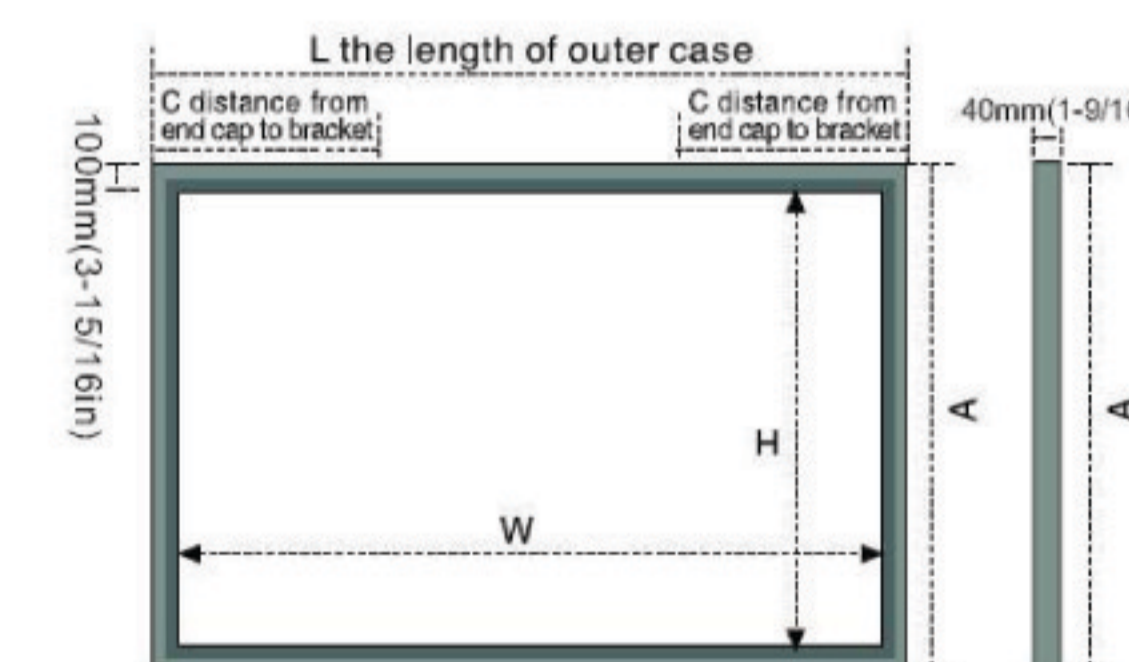

Ultimate Model

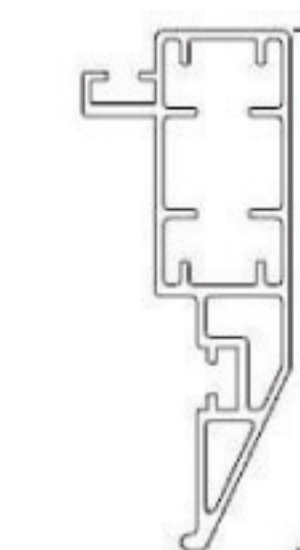

Ultimate Model corner connector piece side view

www.cyberscreens.co.uk - sales@cyberscreens.co.uk  
 Unit 7 Arlington Business Park,  
 Whittle Way, Stevenage SG1 2BE

T: 01438 311 625 - F: 01438 311 626