

EMOTIVA®



RMC-1 & RMC-1L

16 Channel Cinema Processor with Dolby Atmos® & DTS-X™ Technology
User Manual

Important Safety Precautions and Explanation of Symbols



The exclamation point within an equilateral triangle is intended to alert the user to the presence of important installation, operation, and service instructions in this manual.



The lightning flash with arrowhead symbol within an equilateral triangle is intended to alert the user to the presence of uninsulated dangerous voltages within the enclosure that may be of sufficient magnitude to constitute a risk of electrical shock to the user.

Please read this manual thoroughly before attempting to install, configure, or operate the Emotiva RMC-1 or RMC-1L. After successful installation and configuration of the RMC-1, be sure to retain this manual in a safe place for future reference.

Safety is a key component of a long lasting and trouble free installation. Please read and follow all instructions and heed all warnings on the RMC-1 and in this manual. The vast majority of the subsequent safety precautions are common sense. If you are not comfortable with the installation of audio/video entertainment equipment, you should seek the services of a qualified installation professional or call us for help.



WARNING: TO REDUCE THE RISK OF FIRE OR ELECTRIC SHOCK, DO NOT USE THE RMC-1 NEAR WATER OR IN WET LOCATIONS, DO NOT EXPOSE IT TO RAIN OR MOISTURE, DO NOT EXPOSE IT TO DRIPPING OR SPLASHING FROM OTHER SOURCES, AND ENSURE THAT NO OBJECTS FILLED WITH LIQUIDS (SUCH AS VASES) ARE PLACED ON IT. DOING SO MAY RESULT IN DAMAGE TO THE RMC-1 AND THE RISK OF ELECTRIC SHOCK, WHICH MAY RESULT IN BODILY INJURY OR DEATH.



WARNING: TO REDUCE THE RISK OF ELECTRIC SHOCK, DO NOT REMOVE THE COVER FROM THE RMC-1. THERE ARE NO USER-SERVICEABLE PARTS INSIDE THE RMC_1. REFER ALL SERVICE TO QUALIFIED SERVICE PERSONNEL.

Do not install the RMC-1 near or above any heat sources such as radiators, heating vents, or other apparatus that produce heat. Do not block any ventilation openings or heat sinks. Avoid installing the RMC-1 directly above other heat-producing equipment unless sufficient ventilation or forced-air cooling is provided.

Do not install the RMC-1 in locations without proper ventilation. The RMC-1 should not be operated on a bed, sofa, rug, or similar surface that may block vents. The RMC-1 should not be installed in an enclosed location such as a bookcase, cabinet, or closed equipment rack unless sufficient forced-air ventilation is provided.

Always install your RMC-1 according to the manufacturer's instructions and only use attachments or accessories specified by the manufacturer.

Do not install the RMC-1 on any stand, shelf, or other piece of furniture that is unable to support its weight. If a cart is used to move the RMC-1, use caution to avoid injury from tip-over.

Connect the RMC-1 only to power sources of the correct voltage (as shown in this manual and on the RMC-1).

Protect power supply cables from being pinched, walked on, or otherwise damaged. Be especially careful where the power cable enters the power outlet and the RMC-1 unit.

Only connect the RMC-1 to an electrical outlet or extension cord of appropriate type and rating.

DO NOT defeat the safety purpose of a grounding or polarized plug by removing ground pins or using unsafe adapters. A polarized plug has two blades - one wider than the other. A grounding plug has a third ground prong in addition to the two main conductors. The wide blade or third grounding prong is provided for your safety. If the provided plug does not fit your outlet, consult an electrician to replace your obsolete outlet. If you replace the power cord on the RMC-1, only use one of similar type and equal or greater current rating.

The power cable for the RMC-1 should be unplugged from the outlet during severe electrical storms, or when unused for a long period of time.

Only replace the fuses in the RMC-1 with fuses of proper value and voltage rating.

The RMC-1 should only be cleaned as directed in the manual. Avoid spraying liquids directly onto the RMC-1 and NEVER spray liquids into the vents. Care should be taken so that small objects do not fall into the inside of the RMC-1.



You should seek service for your RMC-1 by qualified service personnel if any of the following occur:

1. The power-supply cord or the plug has been damaged.
2. Objects or liquid have fallen or spilled into the vents.
3. The RMC-1 has been exposed to rain.
4. The RMC-1 exhibits a marked change in performance.
5. The RMC-1 has been dropped, or its enclosure or chassis is damaged.

NOTE: TO COMPLETELY DISCONNECT THE RMC-1 FROM THE AC POWER MAINS, DISCONNECT THE AC POWER CORD FROM THE AC RECEPTACLE.

NOTE: THE RMC-1 AC POWER CORD MUST REMAIN READILY ACCESSIBLE AT ALL TIMES.

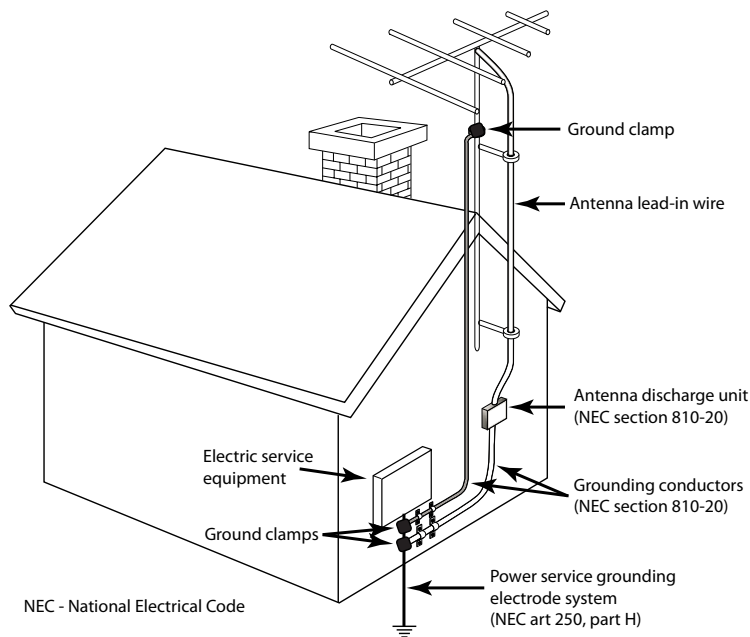
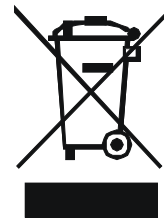
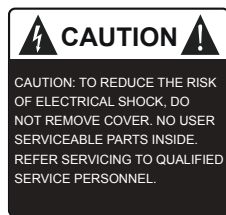

FCC Interference Statement

Note: This equipment has been tested and found to comply with the limits for a Class B digital device, pursuant to Part 15 of the FCC rules. These limits are designed to provide reasonable protection against harmful interference in a residential installation. This equipment generates, uses and can radiate radio frequency energy and, if not installed and used in accordance with the instructions, may cause harmful interference to radio communications. However, there is no guarantee that the interference will not occur in a particular installation. If this equipment does cause harmful interference to radio or television reception, which can be determined by turning the equipment off and on, the user is encouraged to try to correct the interference by one or more of the following measures:

Reorient or relocate the receiving antenna.

Increase the separation between the equipment and receiver.

Connect the equipment to an outlet on a circuit different from that of the receiver.

Consult the manufacturer or an experienced radio/TV technician for help.

For questions regarding service, please contact:

Emotiva Audio Corporation
Attn: Repair Department
139 Southeast Parkway Court
Franklin, TN 37064

1-877-366-8324
www.emotiva.com

Emotiva RMC-1 & RMC-1L

16 Channel Reference Cinema Processors
with Dolby Atmos® and DTS-X™ Technology

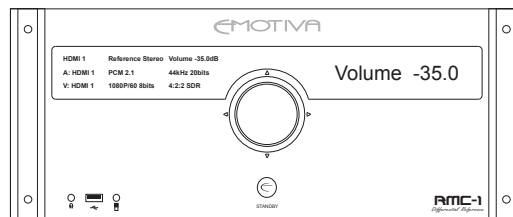

Contents

Important Safety Precautions and Explanation of Symbols

FCC Interference Statement

Introduction	2
About This Manual	3
Unpacking.....	4
Welcome to the Emotiva RMC-1	5
Specifications.....	10
Operating the RMC-1	12
The RMC-1 Menu System.....	26
Operating the RMC-1	66
Care and Maintenance	84
Troubleshooting	91
Appendices.....	93
Emotiva Audio Corporation Five-Year Limited Warranty	98
Notes.....	102

Manufactured under license from Dolby Laboratories. Dolby, Dolby Atmos, Dolby Vision, and the double-D symbol are trademarks of Dolby Laboratories. Copyright © 2018 Dolby Laboratories. All rights reserved.

Manufactured under license from DTS, Inc. DTS, the Symbol, DTS and the Symbol together, DTS:X, and the DTS:X logo, Neural:X, and the Neural:X logo, are registered trademarks and/or trademarks of DTS, Inc in the United States and/or other countries. ©DTS, Inc. All Rights Reserved.

Introduction

Introduction

Thank you for choosing the new Emotiva RMC-1 Sixteen Channel Processor, with Dolby Atmos® and DTS-X™ technology. The RMC-1 is the culmination of years of research and design into audio equipment and surround sound processing, and represents the state-of-the-art in surround sound processors.

The RMC-1 is based on an all new custom designed hardware platform that delivers cutting edge video performance and true audiophile calibre sound quality. Powerful DSP processors decode the latest surround sound formats; high-quality DACs deliver superb quality audio to a highly optimized balanced analog signal path; and hardware-based interstage ASRCs (asynchronous sample rate converters) ensure immunity from the jitter that plagues other processors. The front panel features dual high-resolution graphical OLED displays, which can be configured to provide a variety of useful information about your audio and video sources and the operating status of the RMC-1. Control is via a single large knob, surrounded by an illuminated halo ring, which combines a precision digital encoder and an automotive grade multi-axis controller. The halo ring is blue in normal operation, but has programmable illumination that assists with menu navigation, and pulsates in intelligent patterns to show changes in volume. The RMC-1 can also be controlled using the included all-metal remote control, by most whole-home control systems, or by a remote control application on your computer or smart phone. Firmware updates, when necessary, are no more complex than inserting a USB memory stick. The RMC-1 includes three expansion ports on its rear panel which can accommodate a variety of different hardware expansion modules; the RMC-1L offers exactly the same features and performance, but in a slightly more streamlined cabinet, and lacks the rear panel expansion ports.

Regardless of how you configure it, we designed the RMC-1 first and foremost to deliver true audiophile sound quality. As an audio component, whether playing stereo music or multi-channel surround sound, the RMC-1 delivers performance and sound quality equal to those you would expect from the best high-end analog preamp. As a cinema processor, the RMC-1 supports both traditional surround sound formats like Dolby TrueHD and DTS-HD Master Audio, and the latest cutting edge immersive object-based surround sound formats – Dolby Atmos and DTS:X, and extracts the best possible performance from each. The RMC-1 also includes a full set of powerful controls that let you get the absolute best from your room and speakers. Dirac Live™ provides state of the art room correction with extensive user customization options. Powerful parametric equalizers are available for audiophiles who prefer to manually dial-in their own correction parameters. The RMC-1 can also import filter settings directly from the Room Equalization Wizard™ program, and for those who prefer them, we've included real tone controls with variable bass and treble turnover frequencies and true Fletcher-Munson Loudness compensation.

The RMC-1 provides bit-perfect video switching of all the latest video formats; all of the video inputs and outputs on the RMC-1 are fully compliant with HDMI 2.0b and HDCP 2.2, and support the latest 4k UHD video formats, including HDR and Dolby Vision. Our advanced color OSD displays important status information directly on your TV or projector screen, and our Video On Standby feature allows you to watch video, and even change video inputs, while your audio system is in Standby.

Enjoy your new RMC-1.

The Emotiva Team

About This Manual

About This Manual

This manual will provide you with all the information you need to install and configure your RMC-1 or RMC-1L to achieve its optimum potential.

You may wish to record serial numbers or other purchase information on the Notes page at the back of this manual.

Note: The features, performance, displays, and controls on the Emotiva RMC-1 and RMC-1L are identical. The only significant difference is the three expansion ports on the rear panel of the RMC-1, which can be used to house up to three hardware expansion modules. The RMC-1L is a few inches shorter than the RMC-1, lacks the rear panel expansion ports, and has a slightly smaller front panel Standby button than the RMC-1. From now on we will simply refer to both as the RMC-1. Everything in this manual applies to both the RMC-1 and the RMC-1L unless otherwise noted.

Unpacking

Unpacking

Your RMC-1 was carefully packed and should reach you in perfect condition. If you notice any shipping damage or other issues when you unpack it, please contact Emotiva immediately.

Gently remove your RMC-1 from the packing carton and remove all wrappings and shipping material.

It is important to save the box and all packing materials in case your processor ever needs to be moved or shipped back to the factory for service.

We truly value customer feedback and would like to hear from you.

What's In The Box

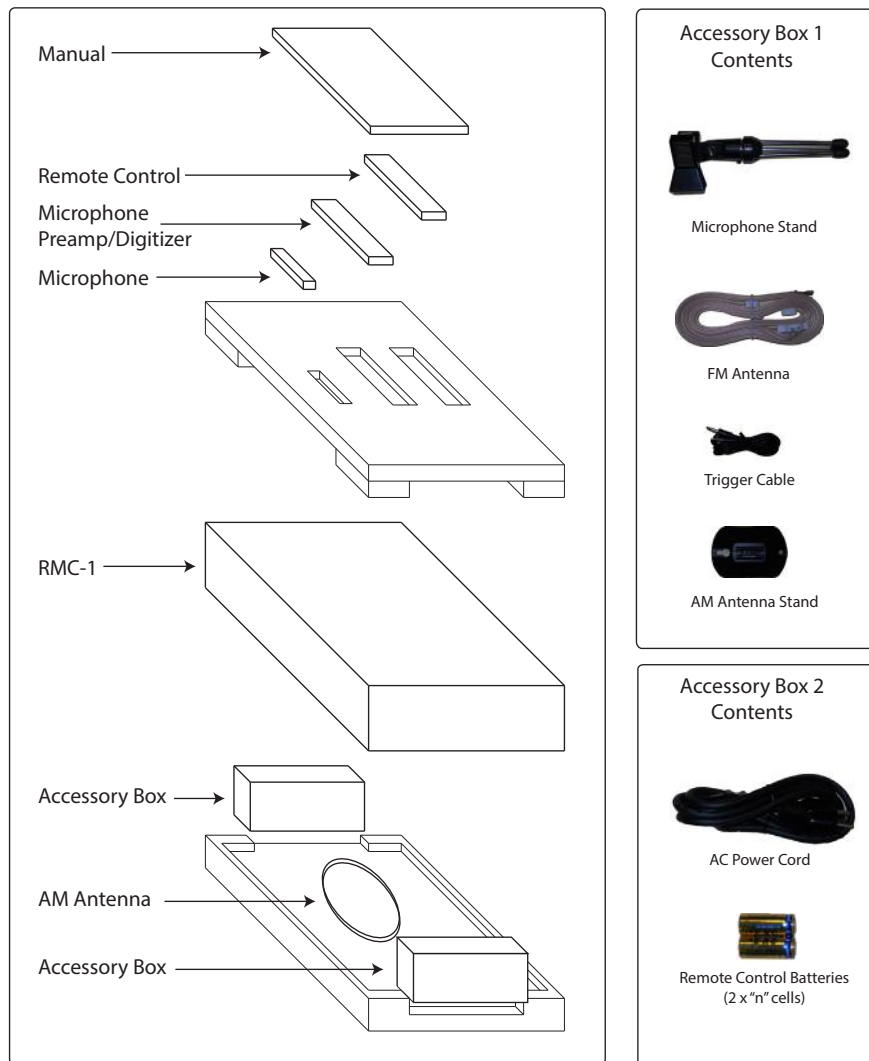

Welcome to the RMC-1

Welcome to the Emotiva RMC-1

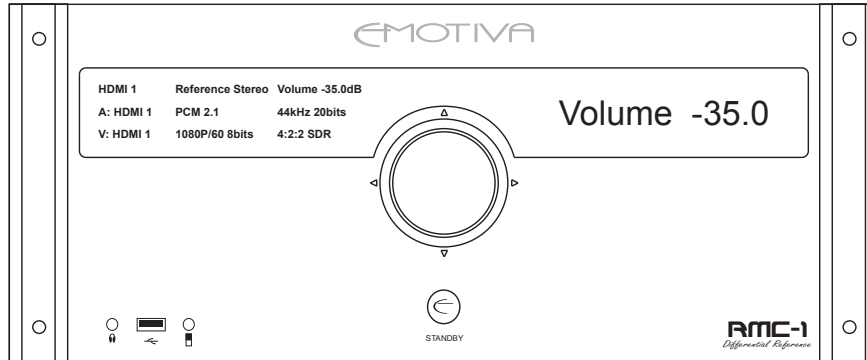

The Emotiva RMC-1 combines enhanced flexibility, cutting edge features, true audiophile sound quality, superior video switching capabilities, and a comprehensive yet easy to use menu and control system - all in a single cinema processor that will redefine your expectations for both stereo music and surround sound performance.

Power, Flexibility, And Ease Of Use

Modern home theater systems can be very complex. To make the RMC-1 powerful and flexible, yet simple to configure and operate, we developed our own custom menu and control system. Frequently used options are easy to find and access, more in-depth options are arranged logically, and the current status is always clearly displayed on the dual informative front panel OLED displays, and the highly configurable on-screen display. The RMC-1 can be controlled from the unique multi-axis front panel encoder, from its iconic solid metal remote control, or using the handy remote control app, which is available for Apple and Windows computers and Android phones. The RMC-1 can also be integrated into most universal remote and whole-home control systems.

Because the RMC-1 is all about power and control, it gives you unprecedented flexibility to configure your system to sound just the way you want it to. Advanced bass management supports up to three subwoofers, and lets you set independent crossover points for each set of speakers. Two entirely separate sets of manual parametric equalizers let you create custom response curves, and can import settings directly from the popular Room EQ Wizard (REW). Settings can be saved as files, exported to a computer, and saved settings can be modified using a simple XML or text editor. Precision bass and treble controls, separate from the more advanced EQ settings, make simple response adjustments easy, and true Fletcher-Munson loudness compensation keeps your music sounding good, even at very low listening levels.

Welcome to the RMC-1

Video Switching For The Latest 4k UHD Video Standards

Home theater video is continually evolving to deliver a sharper picture, more colors, and more advanced features - which can make it difficult to keep track of what you actually need to take advantage of the latest video content and this year's 4k displays. The RMC-1 has eight HDMI video inputs and two HDMI video outputs, all of which support HDMI 2.0b and HDCP 2.2. The RMC-1 supports the full HDMI 2.0b 18 Gbps video data rate, so it supports full 4k UHD video, at frame rates up to 4k/60, with full 12-bit color, and 4.4.4 chroma subsampling. It also supports static and dynamic HDR, including Dolby Vision, for a brilliant picture, with pure, intense colors, and remarkable contrast. The RMC-1 provides everything you need to get the most from the latest streaming content and 4k UHD Blu-Ray discs.

Audiophile Sound Quality

Regardless of how you configure it, we designed the RMC-1 first and foremost to deliver true audiophile sound quality, so it always sounds great. As an audio component, whether playing stereo music or multi-channel surround sound, the RMC-1 delivers performance and sound quality equal to those you would expect from the best high-end analog preamp. As a home theater processor, the RMC-1 supports both traditional surround sound formats like Dolby TrueHD and DTS-HD Master Audio, and the latest cutting edge immersive formats – Dolby Atmos and DTS:X, and gives you the best possible sound quality with each.

The RMC-1 combines superb quality analog circuitry, which enables all of your high quality music to sound its best, with precision digital processing, and plenty of channels and decoding options to ensure you the ultimate listening experience with the latest blockbuster movies and concert videos. Audiophile quality AKM4490 Verita DACs, operating in fully balanced Mono mode, are used for all of the RMC-1's main outputs, and the highest quality analog circuitry and components are used in the RMC-1's fully balanced analog signal paths. With the RMC-1, you really can have a superb stereo music system, and a truly awesome home theater audio system, in a single convenient, practical, and easy to master audio component.

Dolby Atmos® And DTS:X™

Until recently, most popular surround sound formats offered either 5.1 or 7.1 channels, and surround sound music and movie sound tracks were mixed to work well with the standard speaker layouts. Some audiophiles and dedicated video fans chose to install more speakers, including more surround channels, and even speakers above the screen, but all the existing surround sound decoders could do was guess what to send to those speakers. The result was sometimes interesting, but usually less than compelling.

The latest immersive surround sound formats, the most popular of which are Dolby Atmos and DTS:X, have broken this barrier by encoding audio content based on object location rather than static speaker channels. As a result, when decoded properly, this new immersive content can take full advantage of larger numbers of speakers, which can include both surround speakers in a wider variety of locations, and height speakers, specifically positioned to enable sounds to appear above the listener, for a truly immersive three dimensional listening experience.

Welcome to the RMC-1

In order to take full advantage of this new technology, a surround sound processor must both include the advanced technology necessary to decode it properly, and support enough channels to deliver a compelling immersive experience. The Emotiva RMC-1 provides support for sixteen audiophile quality fully balanced audio output channels, which can be configured as fifteen full-range channels and one subwoofer output, or thirteen full-range channels and up to three subwoofer outputs. In addition to this, the RMC-1 includes three expansion slots, which can accommodate up to twelve additional output channels, when and if they are needed, as well as a variety of additional input options.

The RMC-1 supports all of the standard channel configurations specified by the applicable licenses for Dolby Atmos and DTS:X, as well as continuing to fully support existing high quality surround sound formats like Dolby TrueHD and DTS-HD Master Audio. Users familiar with the previous standards will notice a few changes in how they are decoded. All Dolby Atmos content will be decoded using the new Dolby Atmos renderer; and Dolby TrueHD and other Dolby Digital content will be decoded exactly as before; but the older Dolby PLIIx surround synthesizer has been replaced with the more advanced Dolby Surround Upmixer. Likewise, DTS:X content will be decoded by the DTS:X decoder; and DTS-HD Master Audio and DTS Digital content will continue to be decoded as before; but the DTS Neo:6 upmixer has been replaced by the new DTS Neural:X upmixer. New licensing requirements also mandate that, while stereo content may be upmixed into surround sound using a variety of different options, each specific type of digitally encoded content is now associated with a specific upmixer option.

What Is Dolby Atmos?

Dolby Atmos is a surround sound technology which is commonly used in movie theaters and for the sound tracks on Blu-Ray and 4k UHD movie discs and streaming content. With virtually all previous surround sound formats, like Dolby TrueHD and DTS Master Audio, the audio content consists of several tracks, each intended to be played via a specific speaker. With Dolby Atmos, the audio content is divided into bed channels and objects. The bed channels are each played from a specific speaker. However, sound objects are defined as having locations in space; when the audio information is decoded, each object is optimally assigned to one or more speakers, based on the speaker layout you have. Most previous surround sound formats support either five or seven speakers plus a subwoofer; Dolby Atmos adds the option to include width and height speakers. Height channels are used to portray objects above the listener, and are reproduced either by speakers mounted in the ceiling, or by special speakers mounted on top of certain other main channel speakers, and positioned to bounce their audio signal off the ceiling, so it reaches the listener from above.

What Is DTS:X?

DTS:X is an object oriented surround sound technology, and is the main competitor to Dolby Atmos in the USA. While the current version of DTS:X supports fewer channels and options than the current version of Dolby Atmos, the basic principle is quite similar, and updates are planned. We can expect both Dolby Atmos and DTS:X to evolve over time, and the RMC-1 has both the channels and the processing power needed to continue to evolve with them.

Specifications

Flexible Audio Processing Modes

The RMC-1 offers the ultimate combination of advanced surround sound processing modes and purist audiophile options. In addition to the latest high-resolution and immersive object oriented surround-sound modes, Reference Stereo Mode provides absolutely pure audiophile sound with no processing whatsoever, and our refined Direct Mode includes minimal processing options, but still offers bass management.

Powerful Manual Room Correction

For those who prefer to do their own room adjustments, the RMC-1 provides powerful manual parametric equalization controls. The RMC-1 allows you to create two entirely independent EQ presets; each preset includes 11 fully adjustable bands of parametric equalization for each speaker. You can then independently configure each input to use either of the manual speaker presets or the results of the automatic room correction.

Integration With Room EQ Wizard (REW)

Room EQ Wizard is a very popular free software program that allows you to perform many different measurements on your audio system, analyze the results, produce a wide variety of reports and graphs, and calculate correction parameters for use with a parametric equalizer. Correction filter settings generated by REW can be imported into the RMC-1, and filter settings from the RMC-1 can be exported directly to REW. Parametric equalizer filter settings on the RMC-1 are imported and exported using a standard XML file format, which allows them to be exchanged with REW, or exported for manual editing and then re-imported, or saved for later analysis and use.

Dirac Live Automatic Room Correction System

The RMC-1 features the latest version of Dirac Live™, the most advanced automatic room correction system available for both audiophile and home theater systems. Dirac Live performs a series of measurements, then uses sophisticated mathematics to calculate a set of filters which correct both the frequency and time domain response of your room and speakers. The result is crystal clear, accurate sound reproduction, with a cohesive sound stage and excellent rendition of transients - even in less than ideal rooms.

Convenient Tone Controls

In addition to manual parametric equalizers, the RMC-1 also includes true Tone Controls. Both Bass and Treble Controls include fully configurable turnover points, and the Tone Controls are available both as temporary adjustments (Tone Trims) and as persistent controls (which remain set until changed). The Tone Controls and Tone Trims operate independently of each other, and both can be used in conjunction with either Dirac Live or the Manual EQ Presets enabled.

Specifications

True DSD Playback

The RMC-1 offers audiophile quality playback of DSD audio (when received via HDMI from an SACD or a DSD audio file). DSD audio is routed directly to the DACs in the RMC-1, and bypasses all format conversions and other processing, for the most accurate audio rendition possible. The RMC-1 also supports playback of DSD audio content via its USB Stream Input using the DoP (DSD-over-PCM) standard. (This feature is still in the final stages of development and will be available shortly.)

Popular Remote Control Options

The RMC-1 offers a wide range of remote control options, including a solid metal infrared (IR) remote control, network-based remote control, and remote control apps for a variety of portable devices (including Apple devices, Android devices, and Windows computers). Remote control codes will be provided for programming intelligent IR remote controls and for developing network-based remote control applications.

Advanced Video On Standby Mode

The RMC-1 incorporates an advanced feature which not only allows you to watch - or continue to watch - video on your monitor while the RMC-1 is in Standby Mode, but even allows you to change sources while in Standby. This feature is great if you just want to do a quick check of the weather, or let the kids watch TV without turning on your main system.

Multiple Zones

The RMC-1 offers an independent second audio zone, which can deliver a stereo version of the same content that is selected in the Main Zone, or can be configured to play audio from a different source (either digital or analog).

Specifications

Digital Decoding Modes

Dolby Atmos®

Dolby TrueHD

Dolby Digital Plus

Dolby Digital 5.1

DTS:X™

DTS-HD Master Audio

DTS-HD High Resolution Audio

DTS 5.1

DTS ES Discrete 6.1

PCM-Multi 5.1

PCM-Multi 7.1

Digital Post Processing Modes

Dolby Surround Upmixer (DSU)

DTS Neural:X upmixer

Audio Operating Modes

Reference Stereo (purist stereo mode)

Direct Mode (minimal processing; with bass management)

Stereo Mode

All Stereo Mode

Display and OSD

Display

OLED (dual blue; high resolution 256 x 60 pixel graphical; variable brightness)

OSD

Color OSD is displayed over live video, including 4k and 3D sources

(variable transparency; multiple operating modes provide different levels of information)

Specifications

Inputs / Outputs

Analog Inputs

- 1 pair (stereo) – Reference quality analog audio (balanced; XLR)
- 3 pair (stereo) – Reference quality analog audio (unbalanced; RCA)

Digital Inputs

- 8 – HDMI 2.0b / HDCP 2.2
- 4 – Toslink optical S/PDIF digital audio
- 4 – Coax (RCA) electrical S/PDIF digital audio
- 1 – AES/EBU (XLR) digital audio
- 2 – USB Type A digital data (for firmware updates and future enhancements)
- 1 – USB Type B digital audio (“USB DAC” input)
- 1 – Ethernet port (RJ-45) (network connection for Dirac and remote control applications)

Other Inputs

- Internal high-performance AM/FM tuner
(antenna connections: FM - “F” connector; AM - push terminals)

Analog Outputs

- 16 channels – Reference quality main analog audio (balanced XLR)
- 1 pair (stereo) – analog line level Zone 2 output (unbalanced)
- 1 – high quality headphone output (1/8” stereo connector)

Digital Outputs

- 2 – HDMI 2.0b with HDCP 2.2
- 1 – Toslink optical S/PDIF digital audio
- 1 – Coax (RCA) electrical S/PDIF digital audio

Expansion Ports (for future expansion modules)

- RMC-1 (rear panel) – 3
- RMC-1L – N/A

Power / Environmental

Dimensions

RMC-1 – Unboxed: 17” Wide x 15.5” Deep x 7” High (not counting feet)

RMC-1 – Unboxed: 17” Wide x 15.5” Deep x 7.525” High (with feet)

RMC-1L – Unboxed: 17” Wide x 15.5” Deep x 5.25” High (not counting feet)

RMC-1L – Unboxed: 17” Wide x 15.5” Deep x 6” High (with feet)

Operating the RMC-1

Operating the RMC-1

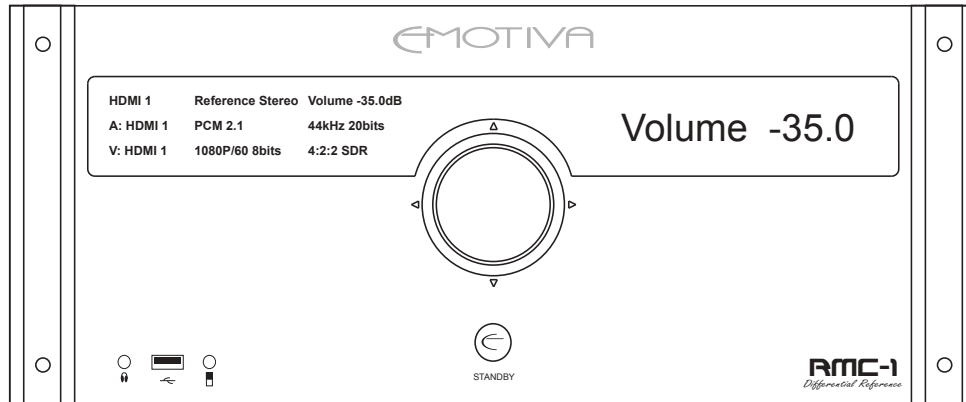

Audio Modes

Reference Stereo Mode

Reference Stereo Mode provides the purest listening experience, with the fewest options for processing or modifying the signal.

In Reference Stereo Mode:

- The output is always *TWO CHANNEL STEREO*.
- There is *NO* bass management, and *NOTHING* is sent to the subwoofer.
- You *CANNOT* use the Loudness Control, or the Tone Presets, or the Tone Trims.
- You *CANNOT* use Dirac Live or the manual Parametric EQ Presets.
- Level Trims, which operate in the analog domain, are still available.
- Speaker Distance adjustments are active for digital inputs but not for analog inputs.
- Stereo analog input signals are passed straight to the Volume Control and the outputs.
- Stereo digital input signals are converted to analog then sent to the Volume Control.
- Surround sound digital signals are decoded, mixed down to stereo (the Center Channel and LFE signals, if present, are mixed into the stereo output), and converted to analog.

Note: Because Reference Stereo Mode does not include bass management, care should be used when playing “small” speakers in this mode. Reference Stereo Mode can ONLY be selected using the “Mode Up/Down” buttons if your front speakers are set to Large, but can be selected as the current mode in the Main Zone Configuration Menu, and can be configured as the default mode for an input.

Note: In Reference Stereo Mode and Direct Mode, you cannot use the Dolby Surround Upmixer, the DTS Neural:X upmixer, or any other post processing mode intended to “enhance” the audio signal. Decoding is limited to converting digital surround signals to analog using the highest quality, purest decoding method possible.

Direct Mode

Direct Mode provides a relatively pure listening experience, and eliminates most processing, but still retains bass management.

In Direct Mode:

- The output contains the same number of channels as the input signal.
- No extra channels are synthesized; if the output channel that corresponds to a given input channel is not present, that channel signal is mixed into the appropriate available channels.
- Bass management *IS* available and the subwoofer *IS* active.
- You *CANNOT* use the Loudness Control, or the Tone Presets, or the Tone Trims
- You *CANNOT* use Dirac Live or the manual Parametric EQ Presets.
- Level Trims, which operate in the analog domain, are still available.

Operating the RMC-1

- Speaker Distance adjustments are available for both analog and digital inputs.
- Stereo digital signals are presented directly to the processor.
- Stereo analog input signals are converted to digital and passed to the processor.
- Surround sound digital signals are decoded, and passed to the processor.
- Multi-channel discrete digital signals (like multi-PCM) are passed directly to the processor.
- All signals receive bass management - but no other processing.
- If an LFE signal is present, and subwoofers are also present, the LFE content will be routed to the subs along with low-frequency content from the main channels (as determined by the bass management settings).

Stereo Mode

Stereo Mode provides a full complement of processing and control options - with a stereo output.

In Stereo Mode:

- The output is always *TWO CHANNEL STEREO*.
- Bass management *IS* available and the subwoofer *IS* active.
- Loudness Control, the Tone Controls, and the Tone Trims are active.
- Dirac Live and the manual Parametric EQ Presets are active.
- Level Trims are active.
- Speaker Distance adjustments are available for both analog and digital inputs.
- Stereo digital signals are presented directly to the processor.
- Stereo analog input signals are converted to digital and passed to the processor.
- Surround sound digital signals are decoded, down-mixed to stereo, and passed to the processor.
- Multi-channel discrete digital signals (like multi-PCM) are down-mixed to stereo and passed to the processor.
- If an LFE signal is present, and one or two subwoofers are also present, the LFE content will be routed to the subs along with low-frequency content from the main channels (as determined by the bass management settings).

All Stereo Mode

All Stereo Mode provides a full complement of processing and control options - with a stereo output. In addition, the left signal is routed to all left side speakers and the right signal is routed to all right side speakers for a "room filling" experience. In All Stereo Mode:

- The output is always *TWO CHANNEL STEREO - routed to all speakers*.
- The left channel is routed to all left side speakers; the right channel to all right side speakers; and the center channel speaker receives a mix of left and right.
- Bass management *IS* available and the subwoofer *IS* active.
- Loudness Control, the Tone Presets, and the Tone Trims are active.
- Dirac Live and the manual Parametric EQ Presets are active.
- Level Trims are active.

Operating the RMC-1

- Speaker Distance adjustments are available for both analog and digital inputs.
- Stereo analog signals are converted to digital audio and routed through the processor.
- Stereo digital input signals are routed through the processor.
- Surround sound digital signals are decoded, mixed down to stereo, and converted to analog (the Center Channel and LFE signals, if present, are mixed into the stereo output).
- After all processing is completed, the left signal is routed to ALL left side speakers and the right signal is routed to ALL right side speakers; and the center channel speaker receives a mix of left and right. .
- If an LFE signal is present, and one or two subwoofers are also present, the LFE content will be routed to the subs along with low-frequency content from the main channels (as determined by the bass management settings).

Immersive (Digital) Surround Sound Formats

Immersive digital surround sound formats like Dolby Atmos and DTS:X contain high-quality multi-channel audio, in the form of both fixed channels, and audio objects, which are assigned to the appropriate speakers when the audio stream is decoded.

Dolby Atmos content is always decoded by the Dolby Atmos Renderer.

DTS:X content is always decoded by the DTS:X decoder.

Discrete (Digital) Surround Sound Formats

Discrete digital surround sound formats like Dolby TrueHD and DTS-HD Master Audio contain high-quality discrete multi-channel digital audio; each channel is stored separately, and the decoded audio is an exact replica of the original content.

For audio encoded in these formats, the RMC-1 will automatically detect the format and use the correct decoder.

Upmixing Surround Sound

The Dolby Surround Upmixer (DSU), and the DTS Neural:X upmixer, are used to synthesize extra channels from the content in existing channels. They may be used to convert stereo content into surround sound content, or to synthesize additional surround sound channels for existing surround sound content.

Dolby Atmos content is decoded by the Dolby Atmos Renderer; upmixing may not be applied to it.

DTS:X content is decoded by the DTS:X decoder; upmixing may not be applied to it.

Dolby Digital and Dolby TrueHD content is decoded by the appropriate decoder; the Dolby Surround Upmixer may be used with it to synthesize extra channel content.

DTS Digital and DTS-HD Master Audio content is decoded by the appropriate decoder; the DTS Neural:X upmixer may be used with it to synthesize extra channel content.

Either the Dolby Surround Upmixer or the DTS Neural:X upmixer may be used with stereo or multi-channel PCM digital content to synthesize extra channel content.

Operating the RMC-1

How the RMC-1 Treats Content in Different Surround Sound Formats

The combination of surround sound decoding and surround sound processing the RMC-1 uses for a given input signal will depend on the format of the incoming signal, and on how you have configured the Surround Mode in the Setup Inputs Menu and Main Zone Menu.

The Setup Inputs Menu allows you to configure the default behavior independently for each input for each type of input signal:

In *Auto Mode* - the RMC-1 will attempt to process the incoming signal to match the number of speakers you have configured - within the constraints listed above. For example, if your RMC-1 is configured for 5.1 speakers, a Dolby TrueHD 5.1 channel input signal will be decoded to 5.1 channels, and a Dolby TrueHD 7.1 channel input signal will be decoded to 7.1 channels, then mixed down to 5.1 channels. If your RMC-1 is configured for 7.1 speakers, a Dolby TrueHD 5.1 channel input signal will be decoded to 5.1 channels, then the Dolby Surround Upmixer will be used to synthesize additional rear surround content to create a 7.1 channel output optimized for your 7.1 channel system.

In *Last Used Mode* - the RMC-1 will use as it's default the same decoding and processing options as were used the last time a similar signal was received on that input.

You will also have the option of manually configuring an initial default mode for each input - for each type of input signal which may be received. The specific options available will depend on the type of input.

Regardless of what decoding and post processing modes are selected automatically by the RMC-1, you will always be able to manually choose to use any combination of decoding and processing modes that are appropriate for the type of input signal being received - either by using the Mode Selector buttons on the front panel or remote control, or from the Main Zone Menu.

Note: If your front speakers are NOT set to Large, Reference Stereo Mode must be configured from the menu system; it cannot be selected manually using the Mode Up/Down buttons.

Note: Dolby Atmos and DTS:X content includes internal configuration settings that enable it to override the default preferences you have configured in your RMC-1. So, for example, a specific Dolby Atmos disc may be configured to render to only four height speakers, which would override the default behavior of expanding that content to all available height speakers.

The RMC-1 Start-Up Routine

The RMC-1 is controlled by a custom Linux-based operating system. Even though loading and initializing the operating system is a complex process, the start up sequence on the RMC-1 has been optimized to minimize the delays you will experience in normal operation.

The start up routine for the RMC-1 will progress differently depending on whether you have enabled the Video on Standby feature in the configuration menu.

Operating the RMC-1

Video On Standby

The RMC-1 has a feature which allows it to operate in a special Standby mode when you switch it into Standby. In this mode, all video and audio processing is disabled, but the RMC-1 will still pass audio and video directly to your TV or monitor, and the controls on the RMC-1 will still allow you to change sources. This feature may be used to allow your family to continue to watch TV on the TV monitor connected to the RMC-1 even when “the big stereo” is turned Off.

The Video on Standby feature is configured in the Setup | Advanced Menu (to use this mode, configure Standby in the RMC-1 for “Video Remains On”).

When the Video on Standby feature is NOT Enabled

When you turn on the rear panel Power switch, the RMC-1 will go into Standby Mode (the halo ring around the front panel Standby button will illuminate amber).

When you then press the front panel Standby button, the RMC-1 will load and initialize the operating system. During this time, the Emotiva logo will appear in the front panel display, and a progress bar will be shown along the bottom of the display.

When the RMC-1 is fully initialized, the display will change to the normal Information display.

Pressing the Standby button on the front panel or the remote control will return the RMC-1 to Standby Mode.

When the Video on Standby feature IS Enabled

When you turn on the rear panel Power switch, the RMC-1 will go into a special Standby Mode which allows the Video on Standby feature to operate even though the main power is off.

When you first turn on the rear panel switch, the halo ring around the front panel Standby switch will illuminate blue. The RMC-1 will then load and initialize the operating system, during which time the Emotiva logo will appear in the front panel display a progress bar will be shown along the bottom of the display.

When the RMC-1 is fully initialized, the display will switch off and the halo ring around the front panel Standby button will illuminate amber. At this point the RMC-1 is in a special Standby mode and the Video on Standby feature is operational.

Note: When the Video on Standby feature is enabled, pressing the Standby button (from On) places the RMC-1 in a special standby mode. The RMC-O/S remains loaded in this mode, and so doesn't have to be re-loaded when you turn the RMC-1 back On. Leaving the Video on Standby Mode enabled allows the RMC-1 to switch from Standby Mode to On very quickly. For this reason, you may prefer to have Video on Standby Mode enabled even if you don't watch video while the RMC-1 is in Standby Mode.

Note: When the RMC-1 is On, or in High Power Standby mode, pressing and holding the Standby button will switch the RMC-1 into Lowest Power Standby mode. (Press and hold the button until a relay click is heard.)

Operating the RMC-1

Bass Management

The RMC-1 has three outputs designated for connecting subwoofers. These can be configured in a number of ways, depending on the number of subwoofers you have, the number of height speakers you have, and your bass management preferences.

The Center Sub output may be configured as either LFE, Mono, or None.

The Left/Right Subs may be configured as either Mono, Dual Mono, Height Speakers, or None.

If the Center Sub is configured as LFE, then all Low Frequency Effects (LFE) content from surround sound sources will be routed directly to the Center Sub, LFE content will NOT be routed to the other subs, and no content will be routed to the Center Sub by the bass management system.

The Dolby Atmos consumer standard only specifies a single subwoofer channel. This channel contains the sum of any content that originates in the Low Frequency Effects (LFE) channel of surround sound material, and any low frequency content that is routed to the subs by the bass management system. This channel is then distributed to however many subwoofers you have configured. (Each subwoofer may be calibrated and adjusted separately, but they all receive the same content, in what would be considered “mono”, “dual mono”, or “triple mono”.)

However, because some users prefer to use different subwoofers for music and for movies, we have included an extra option that provides significantly more flexibility.

If you connect any combination of one, two, or three subwoofers to the appropriate outputs, and configure those outputs as Mono or Dual Mono, all of your subs will be treated equally, and will be used for both LFE content and content directed to your sub by the bass management system.

However, by connecting one subwoofer to the Center Sub output, and then configuring that output as LFE, you may instruct the RMC-1 to use that subwoofer exclusively for LFE content. That sub, in effect, becomes your “low frequency effects speaker” for movies. All LFE content is routed only to that sub, and any low frequency content that is redirected from any other channels by the bass management system is routed to your OTHER sub or subs.

Note: If you plan to connect two subs to the Left Sub and Right Sub outputs, then you must configure the Left/Right Subs outputs as Dual Mono. If you plan to connect only a single sub to those outputs, then you MUST connect it to the Left Sub output, and you must configure the Left/Right Subs as Mono. When Left/Right Subs is set to Mono ONLY the Left Sub output is active. (This setting is independent from the configuration of the Center Sub output.)

Enhanced Bass

Enhanced Bass is a feature which allows you to combine the bass output of your subwoofers with the bass output of your large main speakers.

When Enhanced Bass is **disabled** (normal operation), bass from the LFE channel is routed to your subwoofer (or subs), bass below the crossover frequency of any speaker you have configured as small is also routed to your sub or subs, and bass from any channels you have configured as large is routed to the intended main speaker.

Operating the RMC-1

When Enhanced Bass is **enabled** on the RMC-1, bass from the LFE channel is routed to your subwoofer (or subs), bass below the crossover frequency of any speaker you have configured as small is also routed to your sub or subs, and bass from any channels you have configured as large is routed to the intended main speaker. **IN ADDITION**, bass **from all main speakers configured as large (including the center channel)** is also routed to your sub or subs. (The range of frequencies which is shared with other speakers by speakers set to Large is still controlled by their configured crossover frequency. The default setting for this is 80 Hz, but it may be changed by temporarily setting each speaker to Small, and then adjusting the Crossover Frequency setting associated with it.)

Note: Enhanced Bass is designed to boost the overall amount of bass available. Music is rendered more accurately when Enhanced Bass is DISABLED. Also, since there is no industry standard, Enhanced Bass may be implemented differently on devices other than the RMC-1.

Tone Presets and Tone Trims

In addition to Dirac Live, and the parametric equalizer Preset options, the RMC-1 offers Tone Controls for making broad adjustments to large segments of the frequency band. Bass and Treble Tone Controls have independently configurable turnover points, and operate just like traditional “Bass and Treble” knobs or sliders.

The Tone Presets accessed via the Setup | Speakers | Presets | {preset} | Equalization | System EQ Menu are retained when the RMC-1 is powered Off. The Tone Trims accessed via the Main Zone | Trims | Tone Menu are temporary trims, and are not retained when the RMC-1 is turned Off.

Note: The Tone Presets and Tone Trims on the RMC-1 operate independently, and in addition to the Parametric EQs and Level Trims. (You can use them all at the same time and the effects will add together.)

Note: The RMC-1 utilizes automatic normalization routines to ensure that, no matter what combination of settings you make in the various Tone Presets, Tone Trims, and Level Controls, the RMC-1 will NOT digitally clip the audio signal. Therefore, no combination of settings made in the Level Trims, Tone Presets, or Tone Trims should result in clipping.

Note: Even though the normalization routines in the RMC-1 will prevent clipping under normal circumstances, it is POSSIBLE, by applying positive gain to multiple overlapping bands in the Parametric Equalizers in the RMC-1, to create a situation that will cause the RMC-1 to clip.

WE STRONGLY RECOMMEND THAT YOU AVOID APPLYING POSITIVE GAIN TO MULTIPLE OVERLAPPING PEQ BANDS. If you do so, please check carefully for clipping, and reduce the settings on those bands if any clipping occurs. (If clipping does occur due to band overlap, you must reduce the gain in one of the bands; you CANNOT eliminate it using the Level Trims.)

Operating the RMC-1

Headphone Output

The RMC-1 includes a high-quality front panel Headphone Output; the Main Outputs on the RMC-1 are muted when headphones are plugged into this output. When headphones are connected, all internal EQ processing is disabled (Dirac Live and the Speaker Presets are disabled while the headphones are connected.)

The RMC-1 also includes a unique level of intelligence in how it handles Level Trims and Tone Trims for the headphones; both sets of trims are configured and stored independently for the Main Outputs and the Headphone Outputs. When no headphones are connected, the Tone Trim and Level Trim settings you make apply to the Main Outputs; when headphones are connected, the Tone Trim and Level Trim settings apply to the headphones. When you unplug your headphones, the trim settings return to their previous settings for the Main Outputs; when you plug your headphones back in, they return to the previous settings for the headphones.

Note: Trim settings for BOTH the Headphone Output and Main Outputs are not persistent, and both are reset when you switch the RMC-1 into Standby Mode or switch it Off.

Playing SACD Audio in Pure DSD

There are a wide variety of disc players which support playback of standard SACD discs (and the SACD portion of hybrid discs). These discs are recorded in a special digital audio format called DSD (direct stream digital).

For audio purists who prefer to play the DSD content from SACD discs directly, without modification or processing, the RMC-1 supports direct playback of DSD audio content received over an HDMI connection. In order to utilize this feature, your player must be configured to deliver the unaltered DSD "bitstream" to the RMC-1 via HDMI.

Note: Different players require different settings to enable them to output DSD digital audio without converting it; and some players may not offer this option. On some players, you will select "DSD" as your output mode; on some you may select "bitstream" as your output mode when playing SACDs; and on others you will DISABLE the option "convert SACD output to PCM"; some players may require you to set multiple options on different menu pages.

Note: Many SACDs include versions of the same content in both Stereo and Surround Sound. These are actually separate tracks on the disc, and you must choose the one you want when playing the disc.

Note: Some players can also play DSD audio directly from a DXD or DSDIFF digital audio file. As long as the result is output to the RMC-1 as standard DSD via HDMI it should play as DSD.

Because DSD digital audio cannot be processed in the normal way, and because most purists who choose to listen to unconverted DSD content prefer to avoid any and all conversions and processing, the playback options for DSD content on the RMC-1 are limited. Two channel DSD content may be played in modes equivalent to Stereo and All Stereo, with no bass management or other processing. Surround Sound DSD content may be played in its original 5.1 channels, or the RMC-1 can be configured to duplicate the Surround Channels into the Rear Surround Channels (if you have a 7.1 or 7.2 system), also with no bass management or other processing.

Operating the RMC-1

If your player only supports converting DSD content to PCM, then the RMC-1 will treat it as it would any other PCM digital audio input. If you require bass management, or any other features not available with a DSD signal input, then you should configure your player to send its output to the RMC-1 in PCM format when playing SACDs.

Note: To play digital audio from an SACD, you MUST use an HDMI connection. The copy protection present on all SACD discs (including the SACD layer of hybrid discs) restricts the formats in which players are legally allowed to provide an audio output when playing them. When playing an SACD disc, players are allowed to provide analog audio (if they have analog outputs), and they are allowed to provide a digital audio output over an HDMI connection. They are NOT allowed to provide digital audio from other standard types of digital audio outputs (like Coax S/PDIF or Toslink). When playing an SACD disc, the player will mute all digital outputs OTHER THAN HDMI.

(If you connect only the Coax digital output of your universal disc player to the appropriate input on your RMC-1, you will be able to use that connection to play CDs, and to play the CD layer on hybrid SACDs, but you will get silence if you attempt to play an SACD, or the SACD layer of a hybrid disc, through that output. Some players may provide a lower quality digital audio output from their non-HDMI outputs, and some players will play a few seconds of music from those outputs before the copy protection mutes them, but the only output you can use to play full quality digital audio from an SACD disc is HDMI.)

Future enhancements will enable the RMC-1 to play DSDx2, and to accept DSD via USB (DoP).

Using the RMC-1 Tuner

The RMC-1 includes a high-quality AM/FM tuner, which can play all standard content from terrestrial radio stations. The RMC-1 tuner plays standard FM broadcasts (but not “digital” or “HD” radio broadcasts).

The RMC-1 display will show station or program identification information that is received via the RBDS data system used by many FM stations.

Note: The Name field, which can be configured for each station that is entered as a preset, is manually entered by the user, and is NOT derived from the RBDS information.

Pressing the Tuner direct input button on the remote control will select the Tuner as the active input. Once the Tuner is your selected Input, you can use the direct control buttons on the remote control to move between stations or radio bands.

The AM/FM Button can be used to switch between the AM and FM radio bands.

The Station Up and Station Down buttons can be used to move directly to the next/last configured station preset.

The Seek Up and Seek Down buttons can be used to instruct the RMC-1 to seek in the chosen direction for the next available station with sufficient signal strength to provide acceptable listening quality.

Operating the RMC-1

The Tune Up and Tune Down buttons can be used to instruct the RMC-1 to move up or down to the next station frequency increment.

Note: The Tune buttons allow you to “manually” shift the frequency up or down to the next valid location for a station - whether any station is currently broadcasting at that frequency with sufficient strength for the RMC-1 to tune it or not. This is equivalent to manually turning a tuning dial, and can be used to configure preset stations that are too weak for the RMC-1 to detect automatically, or to configure preset stations that are not currently on the air.

Operating the RMC-1

Manual Room Correction

The RMC-1 offers two separate Manual Room Correction Presets; each Preset can be labelled with a user-defined name; and each includes 11 bands of independent Parametric EQ for each speaker/channel, and Tone Presets (which are applied to all speakers). Each Input on the RMC-1 can be configured to use either of the two Presets, or the results of the Dirac Live Automatic Room Correction.

The parametric equalizers (parametric EQ or PEQ for short) offer 11 independently adjustable frequency bands for each channel/speaker. The center frequency, the width of the band, and the gain or cut, can be independently adjusted for each of those bands. The center frequency for each band is specified in Hz; the width of each band is specified in both Q and in Hz; and the gain is specified in dB. A band with a Q of 1.4 is approximately equivalent to a band in an old-style graphic equalizer; a higher Q value corresponds to a narrower band.

Note: You may adjust the width of each PEQ band by changing either the Q or the width in Hz. Because of the way the RMC-1 updates the display, only the value you are working with will change in real time on the display; the other value will change to match when you exit the field you are adjusting.

There are many different ways in which you can determine the proper values required to calibrate your system and your room using a parametric equalizer. A wide variety of textbooks are available on the subject of room equalization for those who are interested. Some audiophiles prefer to take manual measurements using a sound pressure level (SPL) meter or real-time audio analyzer (RTA). For them the RMC-1 includes sophisticated calibration tools, including a pink noise generator and a highly configurable sine wave generator. Some audiophiles prefer various software solutions; one very popular and incredibly flexible software room calibration tool is Room Equalization Wizard (REW). Some basic tools, including a simple SPL meter, only provide the information you need to manually determine what corrections to make; others, like REW, can provide you with specific values to enter into each PEQ filter on the RMC-1 to achieve a specific result.

The configuration controls for the Parametric EQ on the RMC-1 have been optimized to make this process as simple and efficient as possible - and to minimize the number of buttons you have to press to get the job done:

- You may, of course, adjust all of the filter bands for one speaker, then move on to the next speaker. However, if you prefer to adjust a specific band for all speakers, then move on to adjust the next band for all speakers, the RMC-1 facilitates this by remaining set to the particular EQ band number you're working on when you switch between speakers. For example, if you're adjusting Filter 3 for your Front Right speaker, and you then switch to the Front Left speaker, you will be taken directly to the settings for Filter 3 for the Front Left speaker; this way you can very easily adjust each Filter band sequentially for all your speakers.
- Test Tone Level and Test Tone Frequency settings are global; even though the controls for the Test Tone Generator appear on several different menu screens, there is only a single Test Tone Generator which you are accessing from different places. Therefore, as you move from place to place in the menu system where the Test Tone Generator is used, the Test Tone Generator will remain set at the last Level and Frequency you select until you change it. When you exit the area of the menu where the Test Tone Generator is used, it will automatically switch Off.

Operating the RMC-1

Configuring Triggers

The RMC-1 has four fully independent triggers, each one of which may be configured to activate an associated piece of trigger-enabled equipment when specific conditions are met. For example, you could use the triggers to activate the amplifiers that power your main front speakers whenever you play music, and the amplifier that powers your surrounds, and your powered subwoofer, only when you're listening to a surround sound source.

The triggers on the RMC-1 are configured by checking various boxes in the Setup Triggers Menu.

First, each trigger must be configured to be active when the Main Zone, Zone 2, or both zones are On. The trigger will *only* be active when one or more of the zones it is associated with are active.

Next, each trigger must be configured to be associated with one or more Inputs. The trigger will *only* be active when one or more of the Inputs it is associated with are active.

For triggers associated with Zone 2, the trigger will be active whenever Zone 2 is On *AND* one of the Inputs associated with that trigger is selected.

For triggers associated with the Main Zone, there is an additional condition that must be met. For the Main Zone, each trigger must also be associated with one or more Speaker groups. The trigger will be active whenever the Main Zone is On, *AND* one or more of the Inputs associated with that trigger is active, *AND* one or more of the Speaker groups associated with that trigger is active.

Note: The triggers respond based on how the RMC-1 is configured; the RMC-1 does not detect the presence or absence of an active audio signal on specific channels.

Note: The option to configure associated Speaker groups only pertains to the Main Zone. Therefore, if you only have Zone 2 checked for a particular trigger, the Speakers column will not be displayed. However, if you have both Zone 2 and the Main Zone checked for that trigger, the Speakers column will be displayed; but please remember that the settings in that column *ONLY* pertain to the Main Zone and don't affect the status of Zone 2 triggering.

Note: All of the RMC-1 trigger logic is based on how the RMC-1 is currently configured. Whether your RMC-1 will send audio to the Surrounds will depend on which Input you have selected, the Mode you have configured that Input to use, the configuration of the Preset you have associated with that Input - including whether Surrounds are set to None in that Preset, and the source signal itself. If all these conditions are met, such that the RMC-1 is delivering audio content to the Surrounds, then any triggers associated with Surrounds will be active if their other requirements have also been met.

By default, the four triggers on the RMC-1 are configured as follows:

- Trigger 1: Main Zone (only), *ALL* Inputs, *ALL* Speakers
- Trigger 2: Main Zone *AND* Zone 2, *ALL* Inputs, *ALL* Speakers
- Trigger 3: Zone 2 (only), *ALL* Inputs
- Trigger 4: Main Zone *AND* Zone 2, *ALL* Inputs, *ALL* Speakers

Operating the RMC-1

Note: *In many situations, there are multiple ways of configuring the triggers on the RMC-1 to produce a certain result. Also, once a sufficient combination of conditions is met to cause a given trigger to be active, additional redundant conditions will be ignored. For example, if you configure a trigger to be active when a certain input and Surrounds are active, it will be active when that input and a surround sound mode are selected. Configuring that same trigger to also be active when that same input and Fronts are active would be redundant - because the Fronts are always active when the Surrounds are active - but the extra condition won't affect the end result.*

Headphone

Since triggers are most often used to switch amplifiers On and Off, the triggers on the RMC-1 are normally configured to be disabled when a pair of headphones is plugged into the *front panel headphone jack*. If you uncheck the Headphone Override box for a particular trigger, this override will be disabled.

Note: *The Headphone Override option is useful if you are using one of the RMC-1's triggers to activate your monitor, and you sometimes watch TV wearing headphones; if you uncheck the Headphone Override for that trigger, that trigger will remain active (assuming the other configured conditions are met), even when headphones are plugged in.*

Note: *The RMC-1 detects when headphones are connected by sensing a plug physically inserted into the front panel Headphone jack. If you leave a headphone extension cable plugged into the jack - but with no headphones connected, the RMC-1 will act as if headphones are connected. Also note that, if you use a separate headphone amplifier connected to one of the RMC-1 line level outputs, the RMC-1 will be unaware that you're using headphones.*

As an example of how the Triggers work on the RMC-1, let's assume you have a stereo amplifier which you use to power your Front Left and Front Right speakers, and a five-channel amplifier that you use to power your Surrounds, Backs, and Center speakers. You want both amplifiers to be On when you listen to surround sound movies, but only the Fronts and your stereo amp to be on when you listen to stereo CDs. For this example, we'll assume that you only use the Main Zone.

One way to achieve this result would be to connect your two channel amplifier to Trigger 1, and your five-channel amp to Trigger 3.

You would configure Trigger 1 to be activated *ONLY* by the Main Zone, but leave all the Input boxes checked, and leave all the Speaker boxes checked. This would configure your two-channel amp to be On whenever the Main Zone was on.

You would then configure Trigger 3 to be activated *ONLY* by the Main Zone, leave all the Input boxes checked, but uncheck all Speaker association boxes *EXCEPT* the box for Surrounds. This would configure your five-channel amp to be On whenever the Main Zone is On and any Input is selected, but *ONLY* if you have a mode that uses surround sound selected. Your Surrounds will be Off if you're using Reference Stereo or Direct Mode, but On if you use the Dolby Surround Upmixer or the DTS Neural:X upmixer.

The RMC-1 Menu System

The RMC-1 Menu System

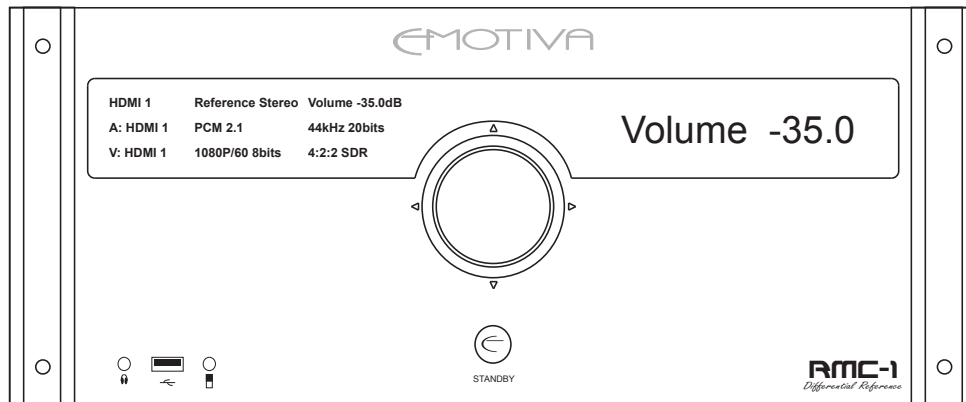

The RMC-1 Menu System

The front panel of the RMC-1 is dominated by a pair of large, bright, easy to read blue OLED displays. The displays can be set to any of six different brightness levels, including totally off. If the display is fully dimmed, it will illuminate for a few seconds when you press the Info button, and, when you activate the Menu, the display will illuminate for as long as you are using the Menu.

HDMI 1

HDMI 1	Surround	Volume -35.0dB
A: HDMI 1	PCM 7.1	48kHz 24bits
V: HDMI 1	1920x1080p/60	RGB 8bits

Volume -35.0dB

FM 104.90MHz	Surround	Volume -35.0dB
Mono 0dBuV		
V: HDMI 1	1920x1080p/60	RGB 8bits

The information displayed on each screen can be configured in the Setup | Preferences menu. By default, the front panel display shows three lines of detailed information about the source that is currently selected, and the audio and video modes currently in effect. When you operate a direct control, like the Volume knob or buttons, or one of the Input selector buttons, the display will momentarily switch to a large, easy to read, representation of the item being chosen or adjusted. When you use the Menu System, the display will switch to show that, then return to the Information screen when you exit the Menu. When using the Setup Menu, settings made on any screen are automatically updated or saved when you exit the screen.

For all menus *except* the Setup Menus, the on screen display will show the same content as the front panel display. In the Setup Menus, if a certain menu screen displays a list of more than three items, the front panel display will show the current item and a single item above and below it, while the on-screen display shows the entire list of items. Also, in the Setup Menu, certain menus show additional useful information on the OSD version (like the user defined name of the Presets).

The RMC-1 Menu System

The knob on the front panel of the RMC-1 is connected to a precision, automotive quality, combination multi-axis controller and encoder.

- Rotating this knob controls the output Volume on the RMC-1.
- Pressing this knob (in) momentarily toggles the Mute function On and Off.
- Pressing this knob (in) and holding it for a few seconds enters and exits the menu system.
- Rocking the knob, or pressing it to the side like a joystick, enables you to navigate the menu, and duplicates the function of the Up, Down, Left, and Right arrows on the remote control.

This is what the front panel menu on the RMC-1 looks like when configuring the various settings for the HDMI 1 Input in the Setup | Inputs Menu.

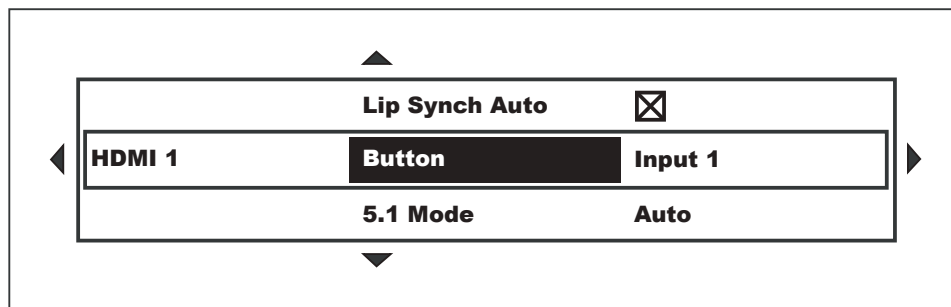

This is what the same Setup | Inputs Menu for HDMI 1 looks like in the on-screen display.

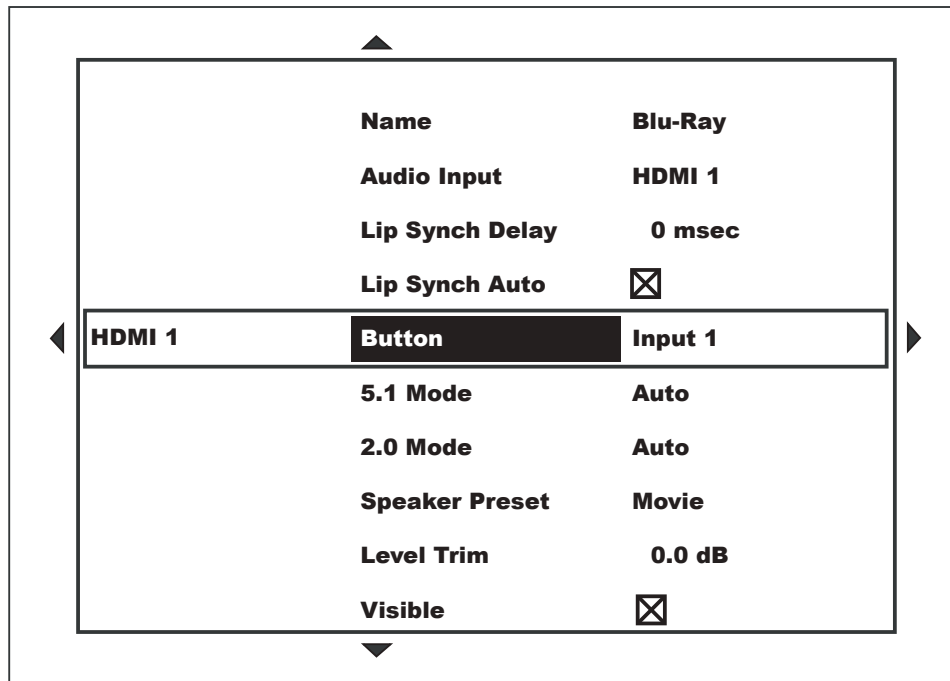

The RMC-1 Menu System

The Menu System is entered by pressing the Menu button on the remote control, or by pressing and holding the encoder knob for a few seconds. Pressing the button a second time, pressing and holding the knob a second time, or using the Left arrow button or encoder control when you are already at the top level of the menu, exits the menu and returns you to the Information Screen. Menu navigation is accomplished using the Up, Down, Left, and Right functions on the encoder of the navigation buttons on the remote control.

The menu system of the RMC-1 is intuitive, and was carefully optimized to make the RMC-1 not only flexible and powerful, but easy to use.

When using the Menu System, the center line of the menu is active. The lines above and below the active center line remain visible to provide context.

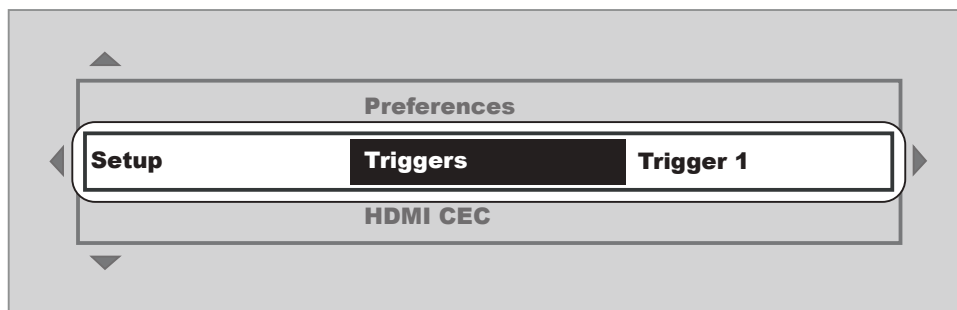

The small arrows to the left, right, above, and below show you which directions you can move in the menu from your current location. Highlight LEDs will also illuminate in the halo ring around the front panel encoder knob to indicate valid directions for movement within the menu.

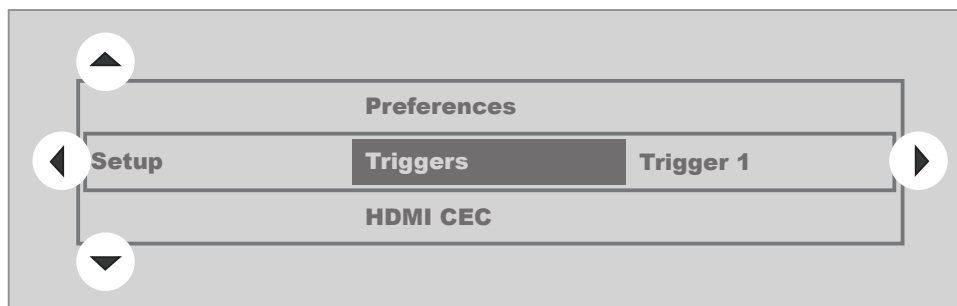

The RMC-1 Menu System

This example will show you exactly how the process works, although it seems a lot more complicated on paper than it does in real life. Once you have an RMC-1 in front of you in person, you'll see how simple and intuitive the RMC-1 Menu System really is.

In this example we'll configure Trigger 1 to come on when the Main Zone Power is On and When Zone 2 Power is On.

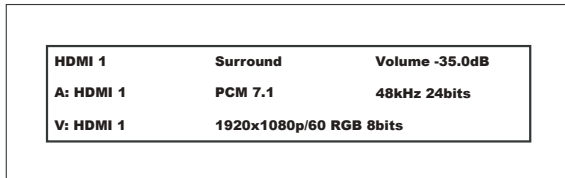

In normal operation the RMC-1 will usually display the Information Screen.

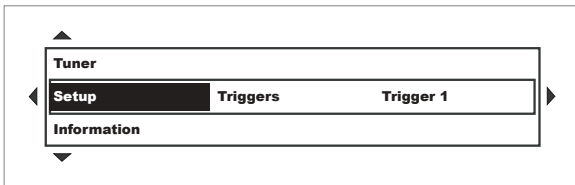

Press and hold the encoder, or press the Menu button, to bring up the Main Menu screen. The highlight shows that the Setup Menu is already the active choice, and the arrows show that we can move up to the Tuner Menu or down to the Information Menu.

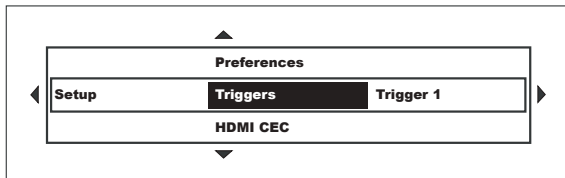

Press the Right arrow button to enter the Setup Menu. Now the highlight shows that the active choice is Triggers, and we can move up to the Setup Preferences Menu or down to the Setup Network Menu. Use the Right arrow button to move to the Setup Triggers Menu.

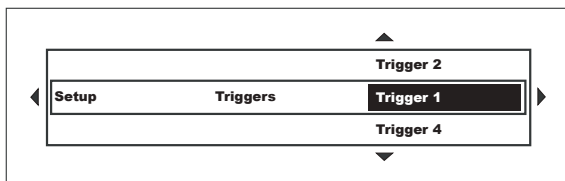

Since we want to configure one of the Triggers, use the Up, Down, and Right arrow buttons to select the particular Trigger we want. At this point the arrows show that we can move up or down to select the Trigger we want to configure. Since Trigger 1 is already the active choice, use the Right arrow button to select it and enter into the Trigger 1 section of the Setup Triggers Menu.

The RMC-1 Menu System

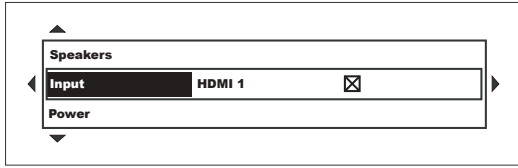

This time the highlight is showing us that the active choice is to configure how Trigger 1 responds to each Input. Since this time the default choice is not the one we want, use the Down arrow button to move to Power, which is the option we want.

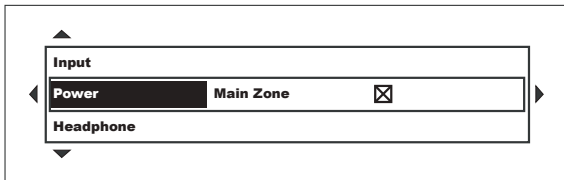

Now the highlight is showing the choice we want, so use the Right arrow button to select it and move into that part of the menu.

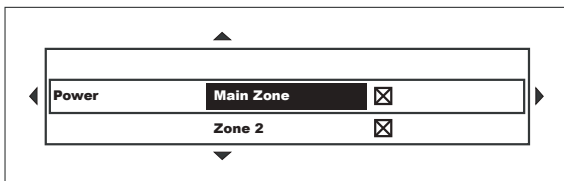

As you can see, we're in the final menu screen for configuring how Trigger 1 will respond to Power conditions. All we have to do is use the Up and Down arrow buttons to select Main Zone, and then Zone 2. Then, for each of those, use the Right arrow button to move to the check box, the Up and Down arrow buttons to check the box, and the Left arrow button to move back to where we are. After we've checked the box for both zones, we'll use the Menu button to exit back to the Information screen.

Note: Since, in our example, we wanted Trigger 1 to remain active when any combination of Inputs and Speakers was used, we left the Inputs and Speakers check boxes set to their default condition - which is "all checked".

Note: Whenever you use the Left arrow button to exit a Menu screen, or use the other arrow buttons to move around the Menu System, all changes you've made in any screen you leave are automatically saved: check a box and it stays checked; uncheck a box and it stays unchecked; change a value and it stays where you set it. You don't have to remember to save settings, or to exit the Menu screen using the correct button. And, at any point, you can exit the Menu System using the Menu button and all your settings will be saved.

Note: Before experimenting with new options or settings, we recommend that you save your current configuration; that way you can discard your changes and return to it if you change your mind. See [Creating a Configuration Backup](#) for details.

Once you try the RMC-1 menu system for a few minutes, you'll realize how incredibly intuitive it really is - and how easy it makes controlling the amazing power and flexibility of the RMC-1.

The RMC-1 Menu System

Main Menu

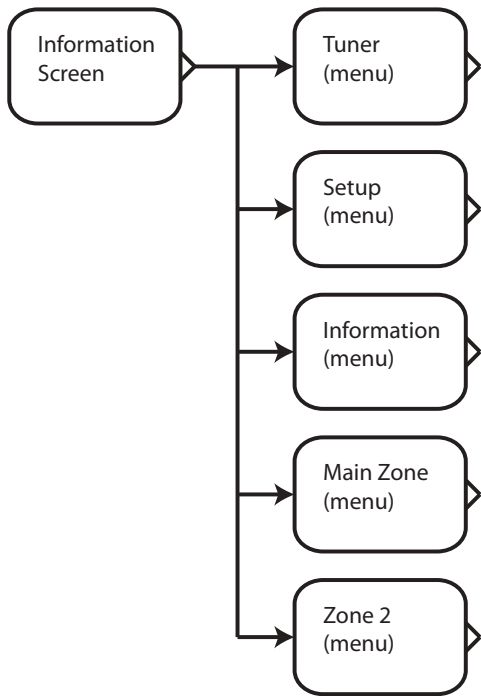

The RMC-1 **Menu System** is displayed by pressing the Menu button, and is displayed on the RMC-1 front panel display and the on-screen display. The Menu System is divided into five major functional categories.

Tuner (menu)

The Tuner menu provides the controls used to operate the RMC-1's built-in high quality AM/FM tuner. Station Presets and Station Names are also configured from this menu.

Setup (menu)

The Setup menu provides all the controls used to configure the RMC-1's various features and settings. These will be covered in detail in the Setup Menu section.

Information (menu)

The Information menu displays information about the RMC-1's Network Address and about the currently installed versions of the RMC-1's various firmware modules.

Note: Information displayed on this screen is read-only. The RMC-1's Network information and Friendly Name can be changed from the Setup Menu if desired.

Note: The Menu screen may appear on either the Left Screen or Right Screen, depending on how your RMC-1 is configured.

Main Zone (menu)

The Main Zone menu provides the controls used to operate the RMC-1's main listening zone in day-to-day use, including Input and Mode selection and the Tone and Level Trims.

Note: Trim adjustments made in the Main Zone menu are temporary and are not saved when the RMC-1 is shut down. To make permanent adjustments, use the Setup menu

Zone 2 (menu)

The Zone 2 menu provides the controls used to operate the RMC-1's second listening zone in day-to-day use.

The RMC-1 Menu System

Tuner Menu

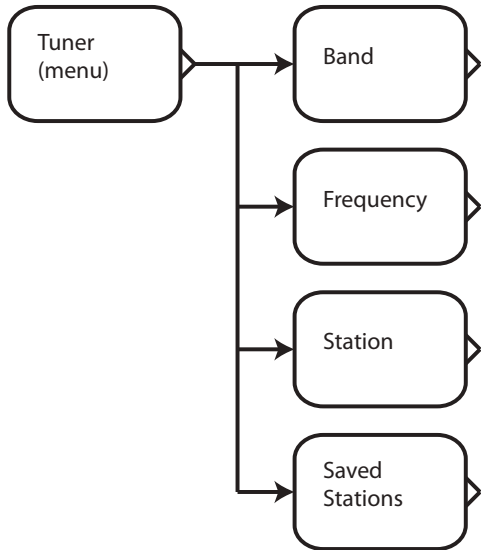

The **Tuner Menu** is used to select a station on the RMC-1's built-in high quality AM/FM tuner, and to create, rename, and delete station presets.

Band & Frequency

The Band and Frequency controls are used to select a radio station to listen to by number (frequency). To do so, simply select the appropriate band (AM or FM) and frequency of the station you wish to listen to.

Station

The Station control is used to select a station to listen to by name. (With this option, you will be able to select any station you have saved and named.)

Saved Stations

The Saved Stations control will act differently depending on whether the station you are currently on has already been saved as a Preset station or not.

If the currently selected station has NOT already been saved - then you will be offered the option to Add it to your list of preset stations. After you choose to Add the current station, you will be offered the option of entering a name for it.

If the currently selected station has already been saved in your list of presets - then you will be offered the choices of Renaming the station preset, or of Forgetting it (deleting it from the list).

Information Menu

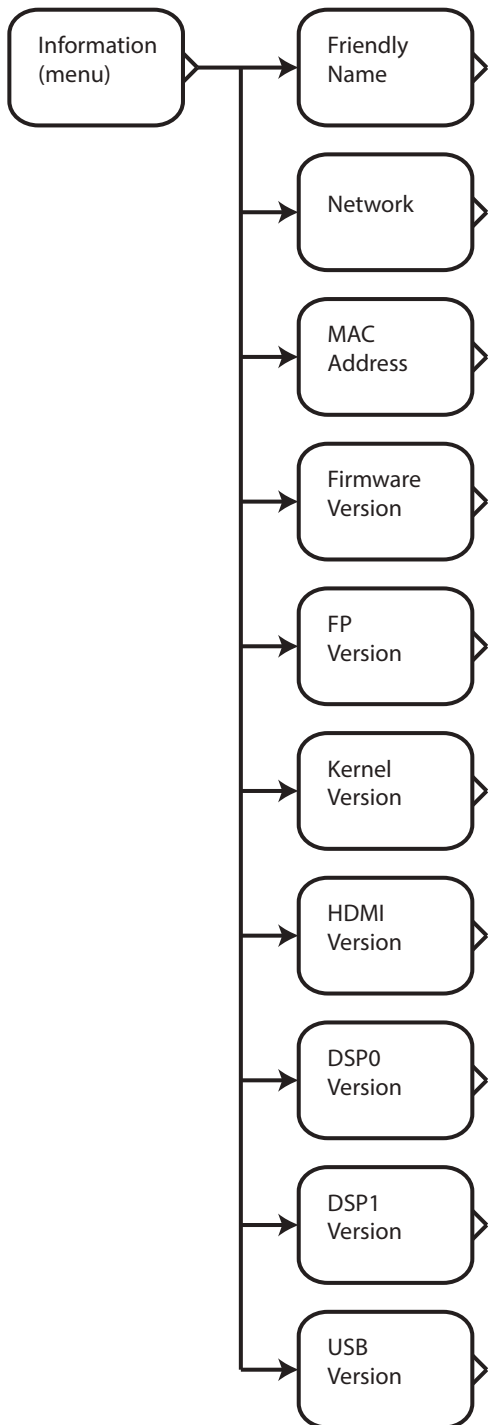

The **Information Menu** gives you access to information about the current Network configuration of the RMC-1, shows the versions of the currently installed firmware modules, and allows you to see the RMC-1's Friendly Name.

The information displayed on this screen is configured from other screens in the Setup Menu and cannot be changed from this screen.

Friendly Name

The Friendly Name is used by various remote control applications to identify the RMC-1 (the default is "RMC-1").

Network

The Network Address is the IP address assigned to your RMC-1. If the RMC-1 is configured to use DHCP, then this address is set by your DHCP server; otherwise it may be entered manually. A valid Network Address is required to configure Dirac Live, and to control the RMC-1 using a network attached remote control. If your RMC-1 isn't connected to a network this address may show as 0.0.0.0 (none).

MAC Address

This is the hardware address assigned to the network interface on the RMC-1. This address may be requested by some routers in order to allow the RMC-1 to access the Internet.

Firmware Version

This is the current version of the main RMC-1 firmware installed on your RMC-1.

FP Version

This is the current version of the Front Panel firmware installed on your RMC-1.

The RMC-1 Menu System

Kernel Version

This is the current version of the operating system kernel installed on your RMC-1. The RMC-1 operates on a highly-customized version of the Linux operating system.

HDMI Version

This is the current version of the HDMI firmware installed on your RMC-1.

DSP0 Version

This is the current version of the DSP0 firmware installed on your RMC-1.

DSP1 Version

This is the current version of the DSP1 firmware installed on your RMC-1.

USB Version Version

This is the current version of the USB interface firmware installed on your RMC-1.

The RMC-1 Menu System

Main Zone Menu

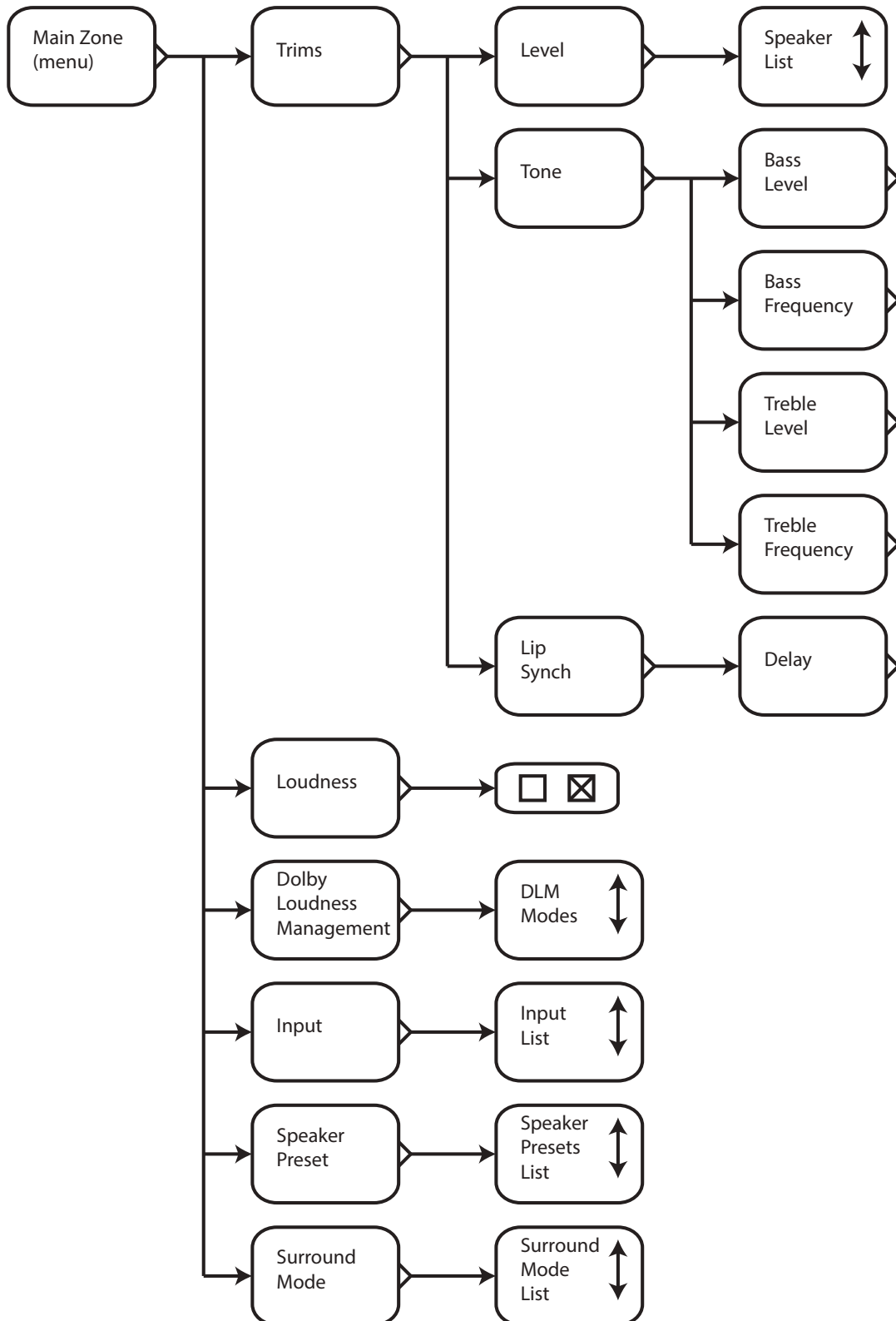

The RMC-1 Menu System

The **Main Zone Menu** contains the settings and controls typically used in the day-to-day operation of your RMC-1. These are settings that are typically chosen each time when viewing content; settings that remain in effect across multiple viewing sessions are accessed from the Setup Menu.

Note: The Level and Tone Trim settings on the Main Zone Menu are temporary trim settings, and apply only to the current listening session. To make changes to these settings that will persist after you restart the RMC-1, you will need to change them in the Setup Menu.

Note: The default settings for several parameters on the Main Zone Menu will be dependent on settings elsewhere in the Setup Menu.

For example, if you have previously set the Treble Adjustment for a given speaker to +5 dB at 5 kHz in the Setup Menu, the Treble Trim in the Main Zone Menu will still initially show the level for that speaker as 0 dB. If you then set the Treble Trim to +5 dB at 5 kHz, that adjustment will be ADDED to the other setting - with the result that Treble will actually be boosted by +10 dB at 5 kHz. If you set the Treble Trim to -5 dB at 5 kHz, it will be ADDED to the +5 dB setting in the Setup Menu - with the result that the Treble will actually be set to +0 dB (flat). When you restart your RMC-1, the Treble adjustment you made in the Setup Menu will remain in effect, while the Treble Trim adjustment you made in the Main Zone Menu will revert to the default +0 dB.

Note: While “stacking” controls for extra gain or cut at a specific frequency is usually not recommended, the RMC-1 will generally normalize the overall level to prevent clipping if you choose to do so.

Note: When the Tuner is selected as your Input, the middle row on the display will show the signal strength of the current station, and whether it is being received stereo or monaural. Since there is no video signal associated with the Tuner, the third row will continue to display information about the last selected video input.

Level Trim

The Level Trim is used to temporarily alter the relative level of each set of speakers. For each set of speakers you may change the level by up to +/- 12 dB in 0.5 dB steps.

Bass Level Tone Trim & Bass Frequency Trim

The Bass Level Tone Trim is used to temporarily alter the relative level of the bass for all speakers by up to +/- 12 dB in 0.5 dB steps.

The Bass Frequency Trim allows you to configure the turnover frequency for the Bass Level Tone Trim to any frequency between 40 Hz and 400 Hz.

Treble Level Tone Trim & Treble Frequency Trim

The Treble Level Tone Trim is used to temporarily alter the relative level of the treble for all speakers by up to +/- 12 dB in 0.5 dB steps.

The Treble Frequency Trim allows you to configure the turnover frequency for the Treble Level Tone Trim to any frequency between 500 Hz and 10 kHz.

The RMC-1 Menu System

Note: The Level Trims, Bass and Treble Trims, and Lip Synch Delay Trim in the Main Zone Menu are independent of those in the Setup Menu and changes configured in the trims operate IN ADDITION TO the levels and settings configured in the Setup Menu.

Lip Synch Delay Trim

The Lip Synch Delay Trim adjusts the lip synch delay from 0 mSec to 200 mSec in 1 mSec steps.

Loudness

The Loudness check box allows you to enable or disable true Fletcher Munson loudness compensation. Loudness compensation adjusts the audio frequency response to compensate for the varying frequency response of human hearing at low volume levels. Our hearing is increasingly less sensitive to very high and very low frequencies as the listening level is reduced, and the Fletcher Munson loudness curve compensates for this by applying a boost to those frequencies that increases as the level is reduced.

Dolby Loudness Management

Enables Dolby Loudness Management and selects which DLM mode to use. When enabled, Dolby Loudness Management attempts to control the dynamic range of incoming audio. Dynamic Range Control (DRC) reduces the dynamic range (the loudness difference between loud and quiet sounds) to make it easier to hear quiet sounds when the overall volume level is low; this is sometimes referred to as "midnight mode". Dialog Normalization seeks to make the dialog in various program material play at a similar level to improve intelligibility.

Note: This option is only available for content encoded in Dolby (not DTS or analog). The exact effect produced by the various settings is determined by information encoded into the source material.

Note: Because DLM only works with Dolby encoded content, it will only function if your source or Blu-Ray player is sending the full digital bit stream, encoded in a Dolby digital format, to the RMC-1 for decoding (if your source is converting the bit stream to PCM, or is in some other format, then DLM will have no effect).

All Off disables both Dynamic Range Control and Dialog Normalization; **DRC Off** disables Dynamic Range Control but enables Dialog Normalization; **Auto** enables DRC (when the flag in the content requests it) and enables Dialog Normalization; **On** enables both DRC and Dialog Normalization.

Input

The Input control is used to select which input on the RMC-1 to listen to or view. Inputs may also be assigned to individual Input Select buttons in the Setup Menu.

The RMC-1 Menu System

Speaker Preset

The RMC-1 has both Dirac Live automatic room correction, and two full banks of parametric equalization that can be used for precise, detailed manual correction of room and system frequency response. The Speaker Preset control allows you to select between the Presets that you have configured in the Setup Menu; listed by the names you have assigned.

Note: Your RMC-1 is configured to use the Presets, and Dirac Live Automatic Room Correction, from the Setup Menu, under Setup Speakers. Dirac Live is executed and configured from a separate computer, which must have network access to connect to the RMC-1 and the Internet.

Surround Mode

The Surround Mode control is used to select which surround mode is used by the RMC-1 to decode incoming audio. This control will present you with a list of available modes and allow you to override the RMC-1's default selection. Selecting Auto on this menu will instruct the RMC-1 to automatically choose the best decoding and processing modes based on the incoming audio.

Note: The RMC-1 will automatically detect the surround mode used by incoming audio and only allow you to choose modes that are appropriate for the type of incoming signal that is detected. If you set the RMC-1 to Auto, it will automatically select the best choice for a given type of input signal; if you configure a specific mode, then that mode will be used; if you configure the RMC-1 to Last Used, then it will use the same surround mode that you manually selected the last time a similar type of input signal was detected.

The RMC-1 Menu System

Dolby Atmos® And DTS:X™ Compatibility

The Emotiva RMC-1 provides support for sixteen audiophile quality fully balanced audio output channels, which can be configured as fifteen full-range channels and one subwoofer output, or thirteen full-range channels and up to three subwoofer outputs. The RMC-1 supports all of the standard channel configurations for Dolby Atmos and DTS:X.)

	Dolby Atmos	DTS:X	Dolby Digital Upmixer	DTS Neural:X Upmixer
Dolby Atmos content	YES	x	x	x
DTS:X content	x	YES	x	x
Dolby Digital content (except Atmos)	x	x	YES	x
DTS Digital content (except DTS:X)	x	x	x	YES
Stereo Analog content	x	x	YES	YES
Stereo PCM content	x	x	YES	YES
Multi-channel PCM content	x	x	YES	YES
DSD content	x	x	x	x

- Dolby Atmos content is *ALWAYS* played using the Dolby Atmos decoder.
- The Dolby Surround upmixer can be used with analog stereo content.
- The Dolby Surround upmixer can be used with stereo PCM or multi-channel PCM content.
- The Dolby Surround upmixer can be used to add channels to non-Atmos Dolby content.
- The Dolby Surround upmixer *CANNOT* be used with Dolby Atmos content.
- The Dolby Surround upmixer *CANNOT* be used with *ANY* DTS digital audio content.

- DTS:X content is *ALWAYS* played using the DTS:X decoder.
- The DTS Neural:X upmixer can be used with analog stereo content.
- The DTS Neural:X upmixer can be used with stereo PCM or multi-channel PCM content.
- The DTS Neural:X upmixer can be used to add channels to DTS content (other than DTS:X).
- The DTS Neural:X upmixer *CANNOT* be used with DTS:X content.
- The DTS Neural:X upmixer *CANNOT* be used with *ANY* Dolby digital audio content.

- The Emotiva RMC-1 supports the standard modes in the Dolby Atmos and DTS:X technology, but does not include any proprietary upmixing technology or options precluded by license.

Dolby Atmos®

Dolby Atmos is a surround sound technology which is commonly used in movie theaters and for the sound tracks on Blu-Ray and 4k UHD movie discs and streaming content. With virtually all previous surround sound formats, like Dolby TrueHD and DTS Master Audio, the audio content consists of several tracks, each intended to be played via a specific speaker. With Dolby Atmos, the audio content is divided into bed channels and objects. The bed channels are each intended to be played from a specific speaker. However, sound objects are defined as having specific locations in space; when the audio information is decoded, each object is assigned to one or more speakers based on the speaker layout you have. Most previous surround sound formats support

The RMC-1 Menu System

either five or seven speakers plus a subwoofer; Dolby Atmos adds the option to include width speakers. Dolby Atmos also specifically supports “height channels”. Height channels are used to portray objects above the listener, and are reproduced either by speakers mounted in the ceiling, or by special speakers mounted on top of certain other main channel speakers, and positioned to bounce their audio signal off the ceiling, so it reaches the listener from above.

Users familiar with the options available under previous surround sound standards may find the options offered by Dolby Atmos systems to be somewhat confusing.

- *ALL DOLBY ATMOS CONTENT IS PLAYED ON THE RMC-1 USING THE DOLBY ATMOS DECODER.*

When Dolby Atmos content is decoded by a Dolby Atmos decoder, both the bed channels and the sound objects are assigned to the appropriate speakers by the Atmos Renderer. Because the Atmos technology is able to assign any object to any speaker or speakers it chooses, and will do so in what it considers to be optimum fashion, there is no option or need to upmix content to ensure that all speakers are used. The Dolby Atmos decoder *ONLY* works on Dolby Atmos content.

- The Dolby Atmos system includes the Dolby Surround upmixer. The Dolby Surround upmixer is a separate option designed to convert non-Atmos content into full surround sound audio, including support for height channels. *THE DOLBY SURROUND UPMIXER CAN BE USED WITH STEREO ANALOG CONTENT, STEREO OR MULTI-CHANNEL PCM DIGITAL AUDIO CONTENT, OR DOLBY DIGITAL CONTENT **OTHER THAN ATMOS CONTENT**, INCLUDING DOLBY DIGITAL AND DOLBY TRUEHD AUDIO. THE DOLBY SURROUND UPMIXER **CANNOT** BE USED WITH DOLBY ATMOS CONTENT OR WITH CONTENT ENCODED USING ANY DTS DIGITAL AUDIO FORMAT.*

DTS:X™

DTS:X is an object oriented surround sound technology, and is the main competitor to Dolby Atmos in the USA.

- *ALL DTS:X CONTENT IS PLAYED ON THE RMC-1 USING THE DTS:X DECODER.* When DTS:X content is decoded by the DTS:X decoder, the decoder assigns the audio content to the appropriate speakers, and is able to assign any object to any speaker or speakers it chooses (within the limitations of the technology). Because of this, there is no option or need to upmix content to create additional channels.

- The DTS:X system includes the DTS Neural:X upmixer. The DTS Neural:X upmixer is a separate option designed to convert non-DTS:X content into full surround sound audio, including support for height channels. *THE DTS NEURAL:X UPMIXER CAN BE USED WITH STEREO ANALOG CONTENT, STEREO OR MULTI-CHANNEL PCM DIGITAL AUDIO CONTENT, OR DTS DIGITAL AUDIO CONTENT **OTHER THAN DTS:X CONTENT**, INCLUDING DTS AND DTS MASTER AUDIO. THE DTS NEURAL:X UPMIXER **CANNOT** BE USED WITH DTS:X CONTENT OR WITH CONTENT ENCODED USING **ANY** DOLBY DIGITAL AUDIO FORMAT.*

The RMC-1 Menu System

Zone 2 Menu

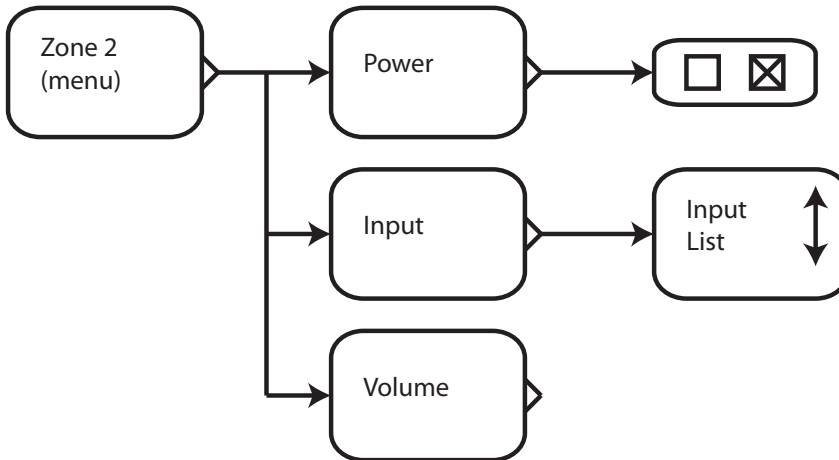

The **Zone 2 Menu** contains the settings and controls typically used to control the second audio zone in the day-to-day operation of your RMC-1. These are settings that are typically chosen each time when viewing content.

Power

The Power check box is used to turn Zone 2 On and Off from the menu system. Zone 2 can also be turned On and Off directly from the remote control.

Input

The Input control is used to select which input on the RMC-1 to listen to or view.

Note: On the RMC-1, the Zone 2 Input is selected independently from the main zone. ANY input that is currently selected as the Main Zone Input can also be routed to the Zone 2 Input - by selecting Follow Main. If you wish to set the Zone 2 Input to a different source than the main zone, you will be able to select ANALOG sources, and 2 CHANNEL PCM DIGITAL sources. You will NOT be able to select a different digital surround sound or HDMI source for the Zone 2 Input than is selected for the Main Zone.

Note: The halo ring on the front panel Standby button will flash alternating blue and amber to remind you when Zone 2 is On.

Note: If the Video On Standby feature is enabled, or the Main Zone is already On, Zone 2 will respond very quickly when turned On. If the Video On Standby feature is disabled, and the RMC-1 Main Zone is Off, then the RMC-1 will have to load its operating system when Zone 2 is turned On, which may take up to one minute

Volume

The Volume control is used to control the level of the Zone 2 output from the menu system. Zone 2 Volume can also be set directly from the remote control.

The RMC-1 Menu System

Setup Menu

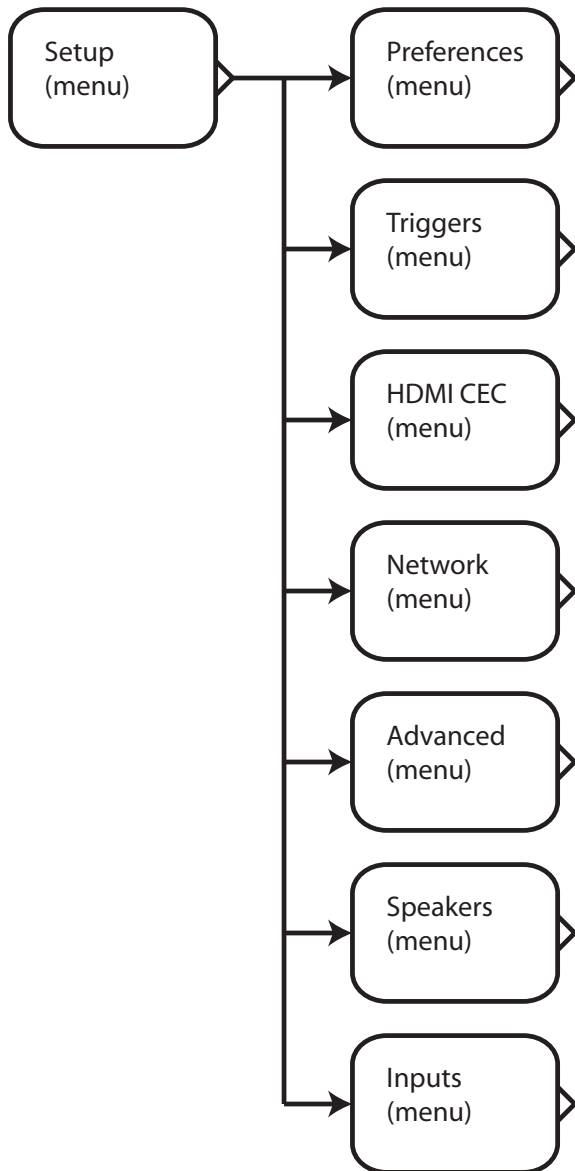

The **Setup Menu** allows you to view and change the main configuration settings for the RMC-1.

Setup | Preferences Menu

The **Preferences Menu** is used to configure various system operating preferences, including Max Volume, Turn-On Volume and Input, and the behavior of the OSD pop up.

Setup | Triggers Menu

The **Triggers Menu** is used to configure the behavior of the RMC-1's four independent triggers.

Setup | HDMI CEC Menu

The **HDMI CEC Menu** is used to configure how the RMC-1 participates in sending and receiving CEC commands.

Setup | Network Menu

The **Network Menu** is used to configure various network parameters for the RMC-1.

Setup | Advanced Menu

The **Advanced Menu** allows you to configure various system operating preferences, including selecting a Standby Mode, and enabling various controls and remote control inputs and outputs. Firmware updates, and resetting your RMC-1 to factory defaults, are also initiated from this menu.

Setup | Speakers Menu

The **Speakers Menu** is used to configure your speakers and room correction, including Dirac Live automatic room correction and manual EQ using the RMC-1's built-in test tones and parametric equalizers.

Setup | Inputs Menu

The **Inputs Menu** is used to configure each Input on the RMC-1, including the Input Name and how the RMC-1 handles various types of input signals on each input.

Setup | Preferences Menu

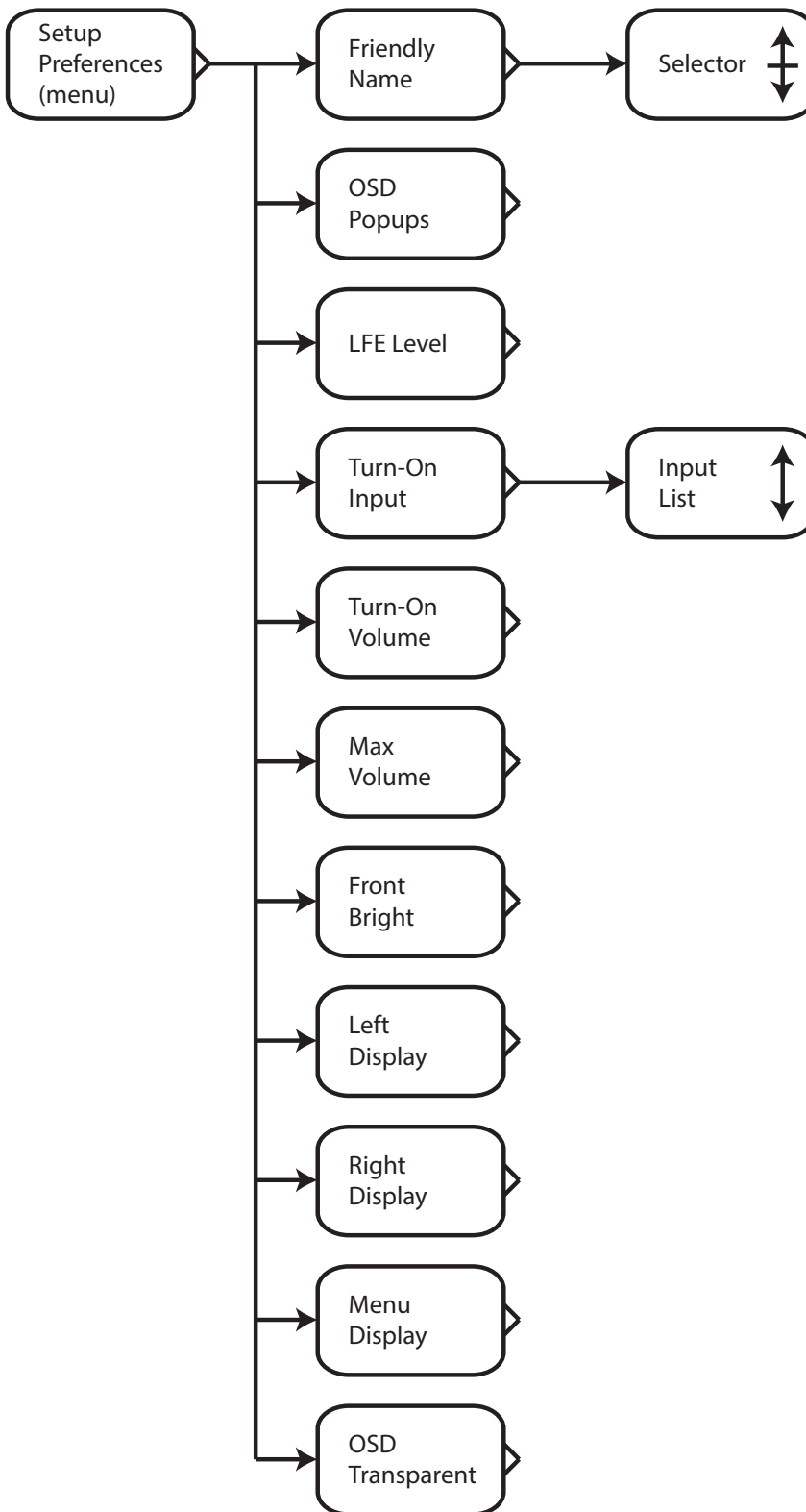

The **Setup Preferences Menu** allows you to configure various general system settings and defaults.

Note: Settings configured in the Setup Preferences Menu remain in effect after the RMC-1 is shut down and restarted.

Friendly Name

The Friendly Name is used by various remote control applications to identify the RMC-1. Up to 10 characters may be used; the default value is "RMC-1".

OSD Popups

The OSD Popups option lets you configure when the pop up information box appears on the screen.

All causes the pop up box to appear whenever user input is received and whenever the incoming signal type or sample rate changes.

User causes the pop up box to appear whenever user input is received, but **NOT** when the incoming signal type or sample rate changes.

None disables the OSD pop up info box completely.

The RMC-1 Menu System

LFE Level

The LFE Level control allows you to adjust the level for the LFE channel for all inputs from 0 dB to -20 dB in 0.5 dB increments.

Turn-On Input

The Turn-On Input setting allows you to configure which Input on your RMC-1 is active when you first turn it on. If you select Last Used, then the input which was in use when the RMC-1 was shut down will be chosen.

Turn-On Volume

The Turn-On Volume setting allows you to configure the Volume Level your RMC-1 will default to when first turned on. Choices are -10 dB, -20 dB, -30 dB, -40 dB, -50 dB, -60 dB, and Last Used; if you select Last Used, then the Volume Level will return to where it was when the RMC-1 was shut off.

Max Volume

The Max Volume setting allows you to configure the maximum Volume Level which can be selected from the front panel Volume knob or the Volume buttons on the remote control. This setting controls the Volume setting in the Main Zone, and can be set from -30 dB to +11 dB in 1 dB increments.

Note; The Max Volume setting is a safety feature intended to prevent you (or other users) from accidentally turning the Volume on your RMC-1 up too high; it does NOT prevent Level Trims from raising the overall Level or gain of the RMC-1, or specifically limit input or output levels.

Front Brightness

The Front Bright control configures the brightness of the RMC-1's front panel OLED display. Display brightness can be set to 0, 20, 40, 60, 80, and 100. If the Front Bright is set to 0, then the front panel display will be entirely dark. If the Front Bright is set to 0, when the user makes an adjustment or operates a control the display will momentarily brighten so the results are visible, then return to full dark after a few seconds.

Left Display, Right Display, Menu Display

The RMC-1 features dual front panel displays, each of which can display different information. The Left Display and Right Display can each be independently configured to show a detailed three line Full Status display, or a single line display that shows Input, Surround Mode, Volume, or Bitstream in a larger font. The Menu Display option selects whether the Setup Menu is displayed on the Left Display or the Right Display when it is shown.

OSD Transparency

The OSD Transparent control configures the transparency of the RMC-1's OSD (on-screen display). Transparency can be set from 0% to 70% in 5% increments.

The RMC-1 Menu System

Setup | Triggers Menu

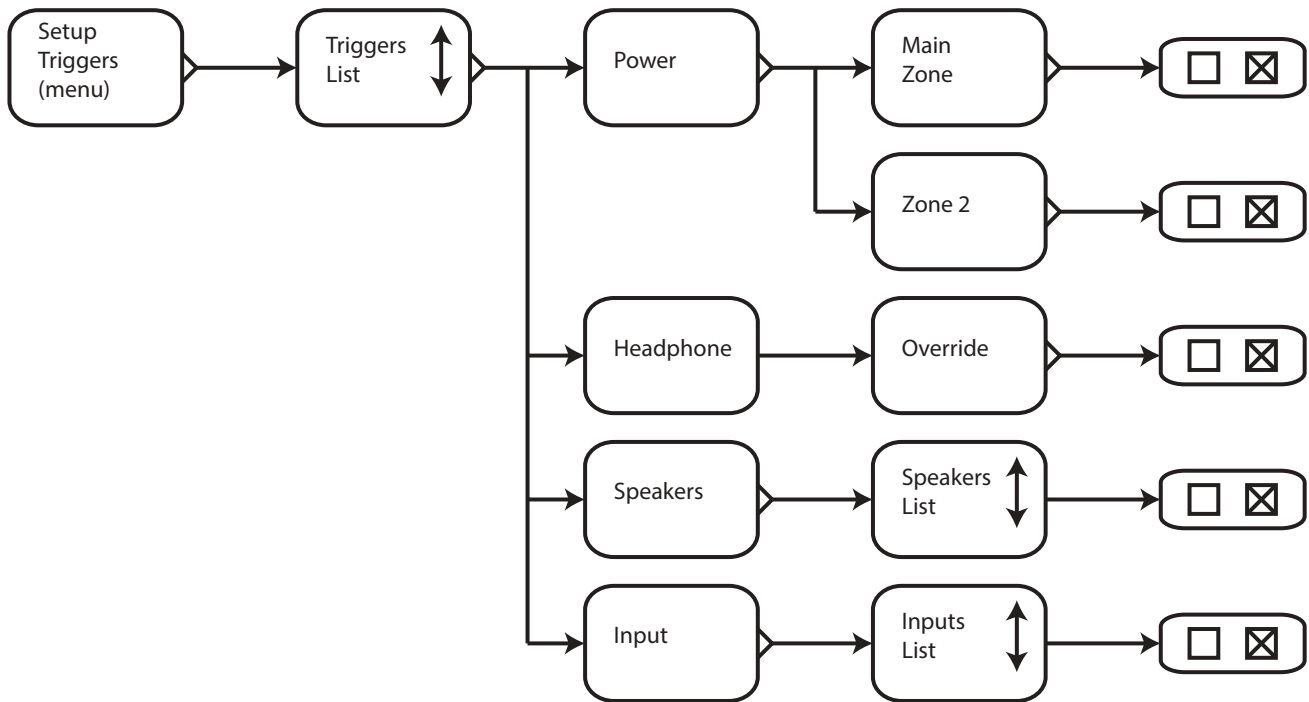

The **Setup Triggers Menu** allows you to configure how the triggers on the RMC-1 operate.

The RMC-1 has four fully independent triggers, each one of which may be configured to activate an associated piece of trigger-enabled equipment when specific conditions are met. For example, you could configure the triggers to activate the amplifiers that power your main front speakers whenever you play music, and the amplifier that powers your surrounds, and your powered subwoofer, to only be activated when you're listening to a surround sound source.

The triggers on the RMC-1 are configured by checking various boxes in the Setup Triggers Menu. All of the following options are available independently for each of the four triggers on the RMC-1.

For triggers associated with Zone 2, the trigger will be active whenever Zone 2 is On *AND* one of the Inputs associated with that trigger is selected.

For triggers associated with the Main Zone, there is an additional condition that must be met. For the Main Zone, each trigger must be associated with one or more Inputs *AND* also be associated with one or more Speaker groups. The trigger will be active whenever the Main Zone is On, *AND* one or more of the Inputs associated with that trigger is active, *AND* one or more of the Speaker groups associated with that trigger is active.

Power

Each trigger must be configured to be active when the Main Zone, Zone 2, or both zones are On. The trigger will *only* be active when at least one of the zones it is associated with are active. Under Power, check the zones for which you want the trigger to be active.

The RMC-1 Menu System

Input

Each trigger must be configured to be associated with one or more Inputs. The trigger will *only* be active when one or more of the Inputs it is associated with are active.

Speakers

For triggers associated with the Main Zone, the trigger will only be active when, in addition to the chosen Input, one or more of the Speaker groups associated with the trigger is active. A Speaker group is considered to be active when the speakers in the group are *NOT* set to None in the Speaker Size Menu, and when you are using a Mode that uses that Speaker group. (Surrounds will be active in modes like Dolby TrueHD, will not be active in Reference Stereo, and may or may not be active in Auto mode, depending on which Modes your RMC-1 has chosen to use.)

Note: The triggers respond based on how the RMC-1 is configured; the RMC-1 does not detect the presence or absence of an active audio signal on specific channels.

Note: The option to configure associated Speaker groups only pertains to the Main Zone. Therefore, if you only have Zone 2 checked for a particular trigger, the Speakers column will not be displayed. However, if you have both Zone 2 and the Main Zone checked for that trigger, the Speakers column will be displayed; but please remember that the settings in that column ONLY pertain to the Main Zone and don't affect the status of Zone 2 triggering .

By default, the triggers on the RMC-1 are configured as follows:

- Trigger 1: Main Zone (only), ALL Inputs, ALL Speakers
- Trigger 2: Main Zone AND Zone 2, ALL Inputs, ALL Speakers
- Trigger 3: Zone 2 (only), ALL inputs
- Trigger 4: Main Zone AND Zone 2, ALL Inputs, ALL Speakers

Headphone

Since triggers are most often used to switch amplifiers On and Off, the triggers on the RMC-1 are normally configured to be disabled when a pair of headphones is plugged into the front panel headphone jack. If you uncheck the Headphone Override box for a particular trigger, this override will be disabled.

Note: The Headphone Override option is useful if you are using one of the RMC-1's triggers to activate your monitor, and you sometimes watch TV wearing headphones; if you uncheck the Headphone Override for that trigger, then that trigger will remain active (assuming the other configured conditions are met), even when headphones are plugged in.

Note: The RMC-1 detects when headphones are connected by sensing a plug physically inserted into the front panel Headphone jack. If you leave a headphone extension - with no headphones attached - plugged into the jack, the RMC-1 will act as if headphones are connected. Also, obviously, if you use a separate headphone amplifier connected to one of the RMC-1's outputs, the RMC-1 will be unaware that you're using headphones.

See **Configuring Triggers** for more information and examples.

Setup | HDMI CEC Menu

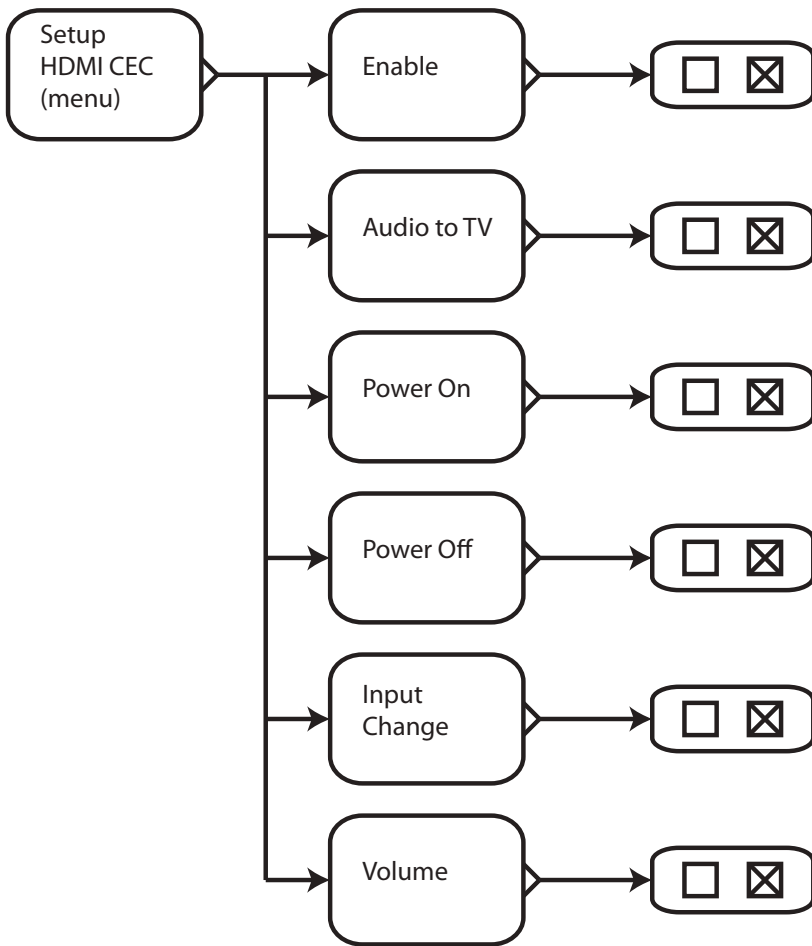

The **Setup HDMI CEC Menu** allows you to configure what types of CEC commands the RMC-1 sends and responds to.

Enable

This check box enables all CEC functionality on the RMC-1. When this box is unchecked, the RMC-1 will not respond to or issue CEC commands. The other options shown on this page will be hidden unless CEC is Enabled.

Audio to TV

Configures the RMC-1 to accept a command to send all audio to the TV for processing.

Note: This command is used by some TVs to “steal audio” from the RMC-1. We normally recommend that it be left disabled.

Power On

Configures the RMC-1 to accept a command to turn On from a connected CEC-enabled device.

Power Off

Configures the RMC-1 to accept a command to turn Off from a connected CEC-enabled device.

Input Change

Configures the RMC-1 to accept a command to switch inputs to display the output of a CEC-enabled device when commanded to do so.

Volume

Allows a CEC-enabled device to control the Volume setting on the RMC-1.

The RMC-1 Menu System

Note: When HDMI CEC is DISABLED only the ENABLE option will be visible. The other options will become visible once you check the box to ENABLE HDMI CEC.

Note: CEC is a system that allows various audio and video components to issue commands to each other; for example, your Blu-Ray player may use CEC to instruct the RMC-1 to switch on and select its input when you insert a disc and press play. Many equipment manufacturers implement some form of CEC control, although they may call it something else, and the features and capabilities of each vary. Because each vendor interprets the CEC standard differently, CEC can cause unexpected and undesired things to happen.

The RMC-1 allows you to individually enable or disable several different CEC functions, allowing you to use the CEC features that prove useful in your system, while avoiding unwanted and unexpected interactions.

Note: The Audio Return Channel (ARC) feature on many TVs requires CEC in order to operate. Therefore, if you fully disable CEC on the RMC-1, you will probably not be able to configure ARC as your audio source.

Note: You do NOT need to have CEC Enabled in order to use Video on Standby Mode; and fully disabling CEC should NOT affect the audio on your TV when you're in Video on Standby Mode.

The RMC-1 Menu System

Setup | Network Menu

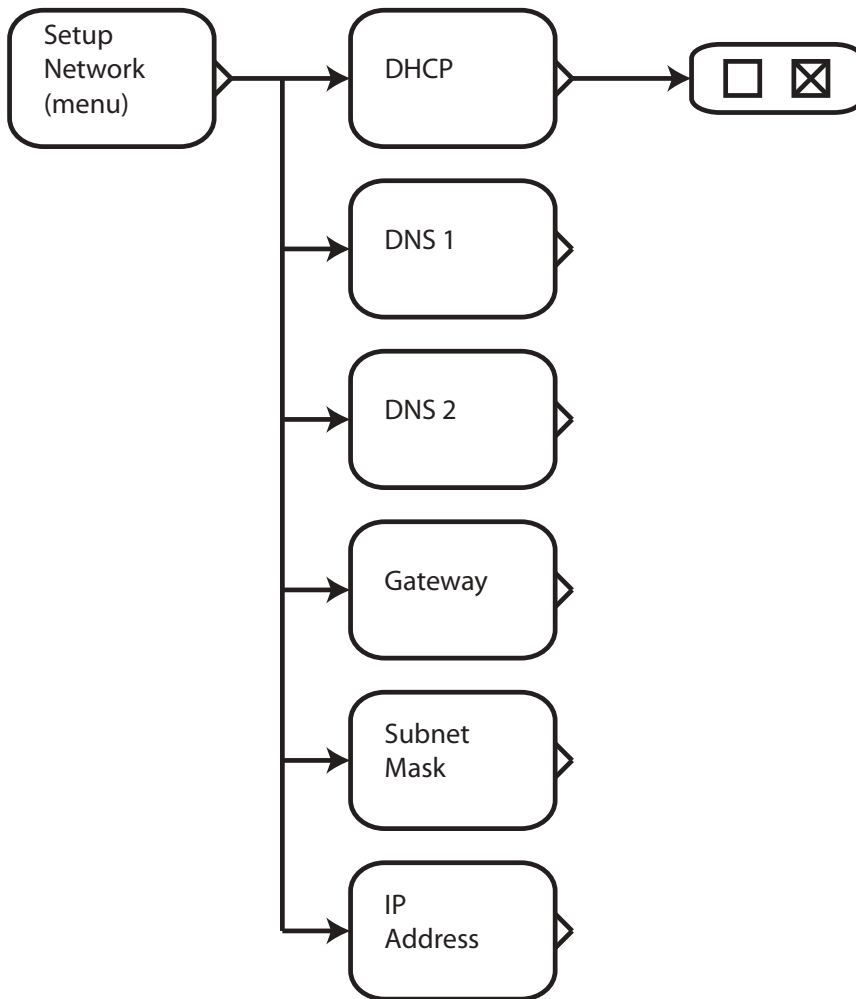

The **Setup Network Menu** allows you to configure various network parameters for the RMC-1.

Note: The RMC-1's Ethernet connection is used to connect the RMC-1 to the Internet via your home network. An Internet connection is required in order to configure Dirac Live automatic room correction, and to allow Ethernet-based or Internet-based remote control apps to connect to the RMC-1. Once Dirac Live is configured, the RMC-1 does NOT need to remain connected to the Internet - or your local network - to operate.

DHCP

If DHCP is selected, then the RMC-1 will obtain all network setup parameters from your local DHCP Server. If you have a cable modem or router, then it probably also provides a DHCP Server for your home network. If your network doesn't have a DHCP server, or you wish to set up the network configuration of your RMC-1 manually, then disabling the DHCP check box will allow you to set each parameter manually.

Note: Most users will find DHCP the best choice. If you prefer to configure your RMC-1 network parameters manually, please consult your network service provider or local computer expert about the appropriate addresses and subnet mask to enter.

Note: If you disable DHCP in the RMC-1's configuration after the RMC-1 has obtained network settings via DHCP, the settings already obtained will NOT be cleared. This can be used as a handy shortcut for manually configuring the network settings in your RMC-1; simply allow the RMC-1 to fill in all the network settings via DHCP, then disable DHCP and manually modify only the settings you wish to change.

Setup | Advanced Menu

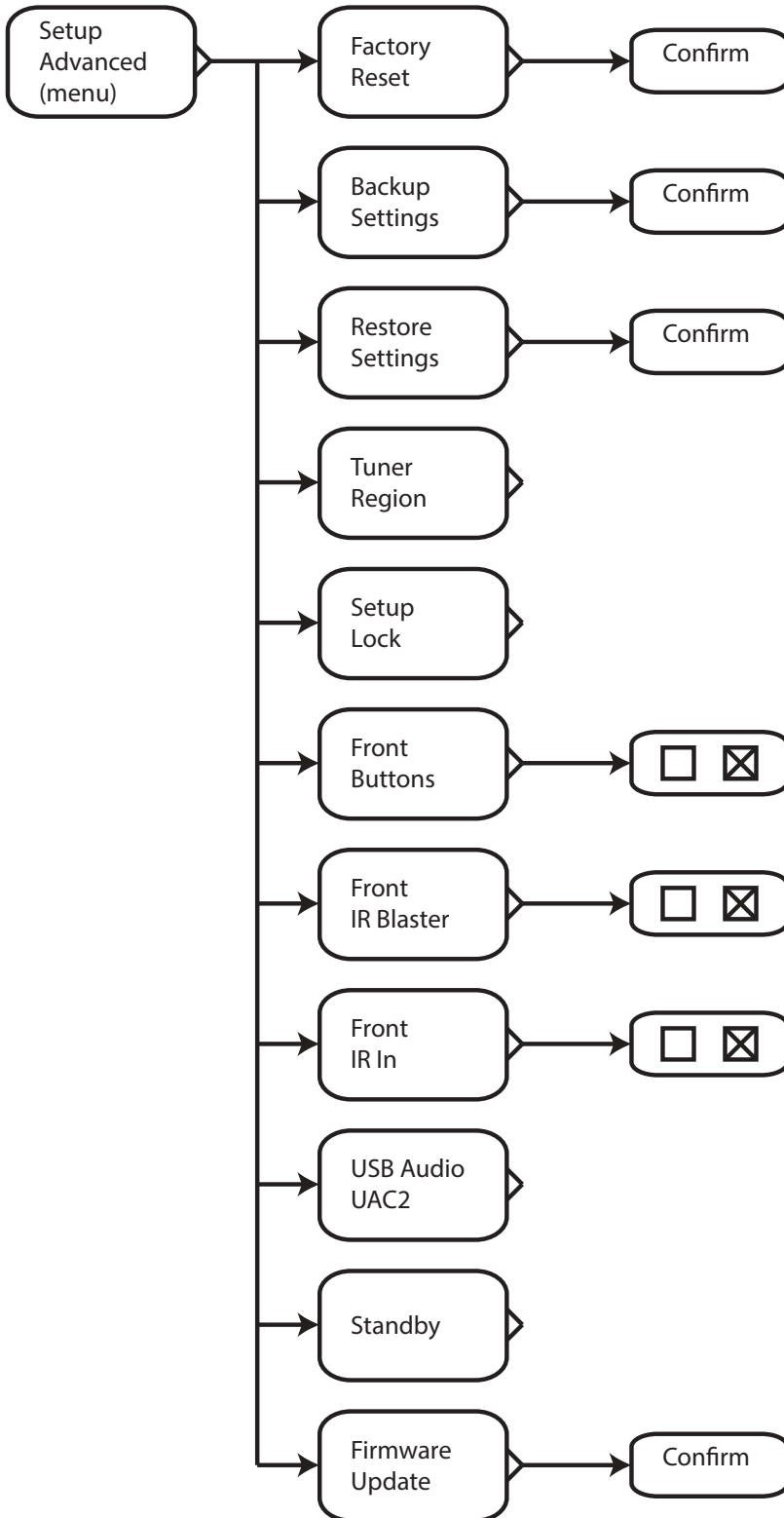

The **Setup Advanced Menu** allows you to configure various system operating preferences, including selecting a Standby Mode, and enabling various controls and remote control inputs and outputs. Firmware updates, and resetting your RMC-1 to factory defaults, are also initiated from this menu.

Factory Reset

Selecting Factory Reset clears all user settings and returns the RMC-1 to its factory defaults. After selecting Factory Reset you will be prompted to Confirm your choice. To do so, check the confirmation box, then use the Left arrow key to confirm the action.

Backup Settings

Selecting Backup Settings instructs the RMC-1 to save a copy of its configuration file. After selecting Backup Settings you will be prompted to Confirm your choice.

Note: *If a USB stick is inserted in the RMC-1, the configuration will be stored there. If no USB stick is inserted, then the configuration will be stored internally.*

The RMC-1 Menu System

Restore Settings

Selecting Restore Settings instructs the RMC-1 to retrieve a stored copy of its configuration file and apply the stored configuration. After selecting Restore Settings you will be prompted to Confirm your choice.

Note: If a USB stick is inserted in the RMC-1, the configuration stored there will be used. If no USB stick is inserted, or no external configuration file is present, then the configuration that is stored internally will be used.

Tuner Region

The Tuner Region setting is used to configure the tuner in the RMC-1 to comply with the correct channel frequency spacing for your region. You may select either **Americas** or **Europe/Asia**.

Setup Lock

Setup Lock is used to prevent the RMC-1's configuration settings from being inadvertently changed.

Selecting **None** will leave all configuration settings unlocked. This is the normal default configuration.

Selecting **Advanced** locks the Setup Advanced Menu - which will then no longer appear on the Setup Menu. This prevents anyone from inadvertently changing any settings on the Setup Advanced Menu, which include resetting the RMC-1 to factory defaults.

Selecting **All** locks the entire Setup Menu.

Note: If you lock the entire Setup Menu - by selecting All, or just the Setup Advanced Menu - by selecting Advanced, you will no longer have access to the Setup Advanced Menu, which will prevent you from changing the lock settings. This will prevent you from unlocking the menus. If you find yourself in this situation, you may still access the Setup Advanced Menu directly by pressing the Standby button on the front panel WHILE PRESSING AND HOLDING THE FRONT PANEL ENCODER KNOB IN.

Front Buttons

Check this box to disable all front panel controls.

Note: This feature is intended to prevent settings on the RMC-1 from being inadvertently changed (and also acts as a "child lock"). If you accidentally become locked out of the RMC-1 by disabling all controls, including the remote control, you can override this feature and access the Setup Advanced Menu by pressing the Standby button on the front panel WHILE PRESSING AND HOLDING THE FRONT PANEL ENCODER KNOB IN.

This will allow you to enter the Setup Advanced Menu and re-enable the controls.

The RMC-1 Menu System

Front IR Blaster

Use this check box to disable the front panel IR blaster.

Front IR In

Check this box to disable the front panel IR Input.

Note: When the front panel IR Input is disabled, the remote control will NOT function unless an external IR remote sensor ("eye) is used.

USB Audio UAC2

By default , the USB Stream Input on the RMC-1 operates as a USB Audio Class 1 device. This enables it to accept USB audio at sample rates up to 24/96k from most devices, including most phones, and most computers, without requiring the user to install extra drivers. By enabling USB Audio Class 2 (UAC2) operation, the USB Stream Input will accept USB audio up.

Standby

Use this option to enable the RMC-1's Video on Standby feature.

Selecting **Video Remains On** will configure the RMC-1 to use its Video on Standby Mode. When this mode is selected, the RXMC-1 will continue to pass video and audio from the selected input source to the display, and will allow you to change the Input source, even when the XMC-1 is in Standby Mode. The XMC-1 uses slightly more power when in Standby Mode if Video on Standby Mode is enabled.

Selecting **Lowest Power** will configure the RMC-1 to use its lowest power Standby Mode. In this mode, video and audio will NOT be passed to the display when the RMC-1 is in Standby Mode.

Note: When the RMC-1 is set to Video on Standby Mode, the RMC-1 Operating System remains loaded when the RMC-1 is in Standby Mode. Because a significant portion of the start up time on the RMC-1 is used to load the operating system, setting the RMC-1 to use Video on Standby Mode will considerably shorten the amount of time it takes the RMC-1 to wake up from Standby Mode.

Note: The start-up sequence on the RMC-1 is different depending on which Standby Mode you have configured the RMC-1 to use.

In Lowest Power Mode, turning the XMC-1 On using the rear panel Power switch will cause it to immediately enter Standby Mode (halo ring around the Standby button lit amber). Pressing the Standby button will then cause the RMC-1 to load the RMC-1 Operating System and turn fully On. The RMC-1 Operating System is loaded during this start up sequence, which may take up to one minute. Pressing the Standby button when the RMC-1 is On will cause it to return to Standby Mode (and unload the operating system).

The RMC-1 Menu System

In Video on Standby Mode, turning the RMC-1 On using the rear panel Power switch will cause it to first load the RMC-1 Operating System, then return to Standby Mode. (While the operating system is loading, the halo ring around the Standby button will illuminate blue. Once the operating system is loaded, the RMC-1 will drop into Standby Mode and the halo ring will change to purple.) Since the operating system remains loaded while the RMC-1 is in Standby Mode, switching between On and Standby Mode can then be accomplished very quickly.)

Firmware Update

Selecting Firmware Update instructs the RMC-1 to load a firmware update from the inserted USB stick. After selecting Firmware Update you will be prompted to Confirm your choice. Use the Up Arrow to confirm that you want to perform a Firmware Update, then the Left Arrow to start the update process. **DO NOT TURN OFF YOUR RMC-1 UNTIL THE FIRMWARE UPDATE PROCESS HAS COMPLETED!**

Setup | Speakers Menu

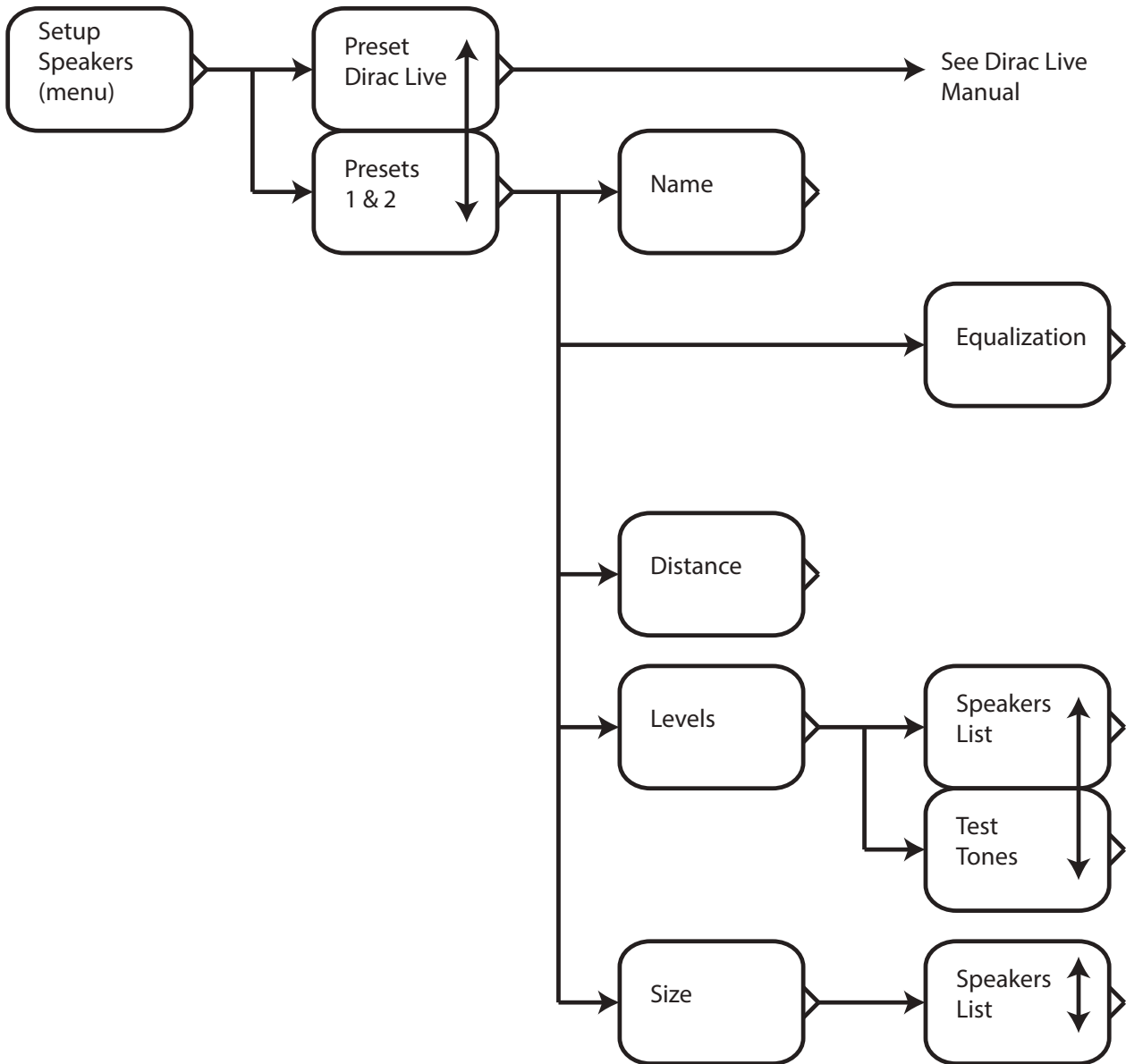

The **Setup Speakers Menu** is where you access the powerful speaker and room correction features of the RMC-1, including Dirac Live automatic room correction, and the RMC-1's incredibly flexible manual calibration system, which includes two fully independent banks of parametric equalizers, along with pink noise and test tone generators.

When you first enter the Setup Speakers menu, you will be asked to choose between Dirac Live automatic room correction and the two available EQ presets. (When you configure the EQ presets, you will get to assign each a name, which will then appear when you Setup Inputs and when you choose a preset in the Setup Speakers Menu; the default names for the two presets are Preset 1 and Preset 2.)

The RMC-1 Menu System

If you chose Dirac, you will be sent to the Dirac Live Menu.

If you choose to manually configure a preset, you will be prompted to choose Preset 1 or Preset 2, and the following settings will be available for EACH preset.

Name

The Name setting allows you to set an alphanumeric “human friendly” name for each Preset.

Distance

The Distance setting will present you with a list of speakers, and allow you to manually enter a distance measurement for each.

Size

The Size screen will enable you to configure the sizes, crossover frequencies, and crossover slopes for your speakers, the configuration of your Rear Surround speakers, and the configuration of your subwoofers.

For each type of speaker you set to Small, you will be able to set a **Crossover Frequency** between 40 Hz and 200 Hz in increments of 10 Hz.

Note: The option to Enable Enhanced Bass will be shown in the Speaker | Size menu when it is available. (The Enhanced Bass option is only available when some of your speakers are set to Large.)

Levels

The Levels screen allows you to adjust the relative level of each speaker by up to +/- 12 dB in 0.5 dB increments, and provides a pink noise test tone to help you perform SPL measurements. The test tone can be set to three different levels (Low, Medium, and High), or can be disabled if you prefer to use your own test signal source.

Note: The actual sound level at which the test tones will play in your listening room will depend on the gain of your amplifiers and the efficiency of your speakers. Always select the setting that produces the appropriate level with your equipment.

Note: Certain speaker configuration options will only appear in the Menu under certain conditions - when you are permitted to select or enable them. For example, the ability to configure Center Height Speakers will be hidden unless you have already enabled Front Height and Rear Height speakers. As a result, these options must be enabled or configured in a certain order.

Note: DIRAC LIVE options and Speaker Presets are initially disabled/invisible in the Menu System. These will be visible and operate as described when the Dirac Live software is finalized.

Note: If you select an external signal source for use with setting Levels, the source Input that is currently selected will be summed for left and right, then that signal will be routed individually to the channel you are currently adjusting.

The RMC-1 Menu System

Setup | Speakers | EQ

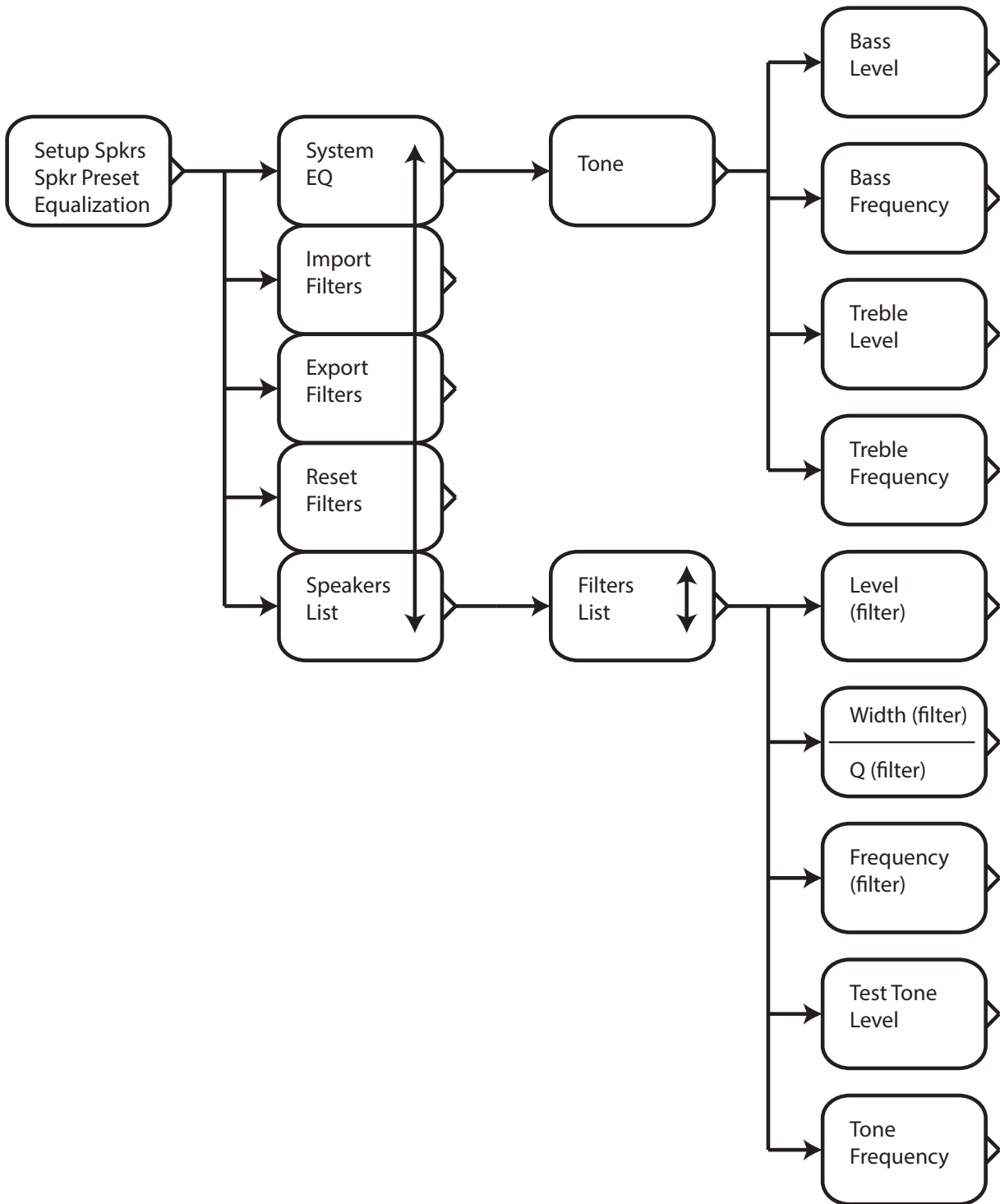

The RMC-1 Menu System

Once you have set the basic parameters for each preset (Speaker Size, Crossover Points, and Level Trims), you can use the RMC-1's powerful Parametric EQ filters and convenient Tone Controls to customize the sound just the way you want. Both the Tone Controls and the Parametric EQ filters may be used at the same time, giving you the precision and flexibility of Parametric EQ for detailed adjustments combined with the convenient sweeping tonal corrections offered by Tone Controls.

System EQ | Tone Presets (Tone Controls)

Note: The Tone Presets apply to all speakers (in the Preset you are currently configuring). Each Speaker Preset has its own independent set of Tone Presets.

Bass Level & Frequency Controls

The Bass Level Control is used to alter the relative level of the bass for all speakers by up to +/- 12 dB in 0.5 dB steps.

The Bass Frequency Control allows you to configure the turnover frequency for the Bass Level Control to any frequency between 40 Hz and 400 Hz.

Treble Level & Frequency Controls

The Treble Level Control is used to alter the relative level of the treble for all speakers by up to +/- 12 dB in 0.5 dB steps.

The Treble Frequency Control allows you to configure the turnover frequency for the Treble Level Control to any frequency between 500 Hz and 10 kHz.

Parametric EQ Filters

Note: There are 11 independent bands of full parametric equalization for EACH speaker in EACH of the two presets.

Note: If you're not familiar with using a parametric equalizer, you should understand that EACH band in a parametric equalizer can be configured to affect a wider or narrower range of frequencies. Even though the RMC-1 provides 11 bands of PEQ for each speaker, because of the combination of power and flexibility you get with parametric controls, you may only need to use one or two bands to make the required adjustments in a given situation. In fact, for various technical reasons, it's actually better to use the fewest bands you can to produce the necessary result.

The Test Tone Generator used to adjust the parametric equalizers generates a pure sine wave at a single configurable frequency.

Note: The actual sound level at which the test tones will play in your listening room will depend on the gain of your amplifiers and the efficiency of your speakers. The SPL values shown for the different test signal output levels are estimates based on typical amplifier gain and speaker efficiency; always select the setting that produces the appropriate level with your equipment.

The RMC-1 Menu System

The behavior of the controls used to adjust the parameters for the parametric equalizers in the RMC-1 has been meticulously optimized to make the process of making so many adjustments as simple and straightforward as possible. As a result, certain displayed fields will be synchronized even though they may be independently configurable. Others may display the same information in multiple locations to make the process of adjusting them easier.

It may take you a little while to get used to the way the controls work but, once you practice a little bit, we're sure you'll find them efficient, convenient, and, most important of all, not confusing.

- You may, of course, adjust all of the filter bands for one speaker, then move on to the next speaker. However, if you prefer to adjust a specific band for all speakers, then move on to adjust the next band for all speakers, the RMC-1 facilitates this by remaining set to the particular EQ band number you're working on when you switch between speakers. For example, if you're adjusting Filter 3 for your Front Right speaker, and you then switch to the Front Left speaker, you will be taken directly to the settings for Filter 3 for the Front Left speaker; this way you can very easily adjust each Filter band sequentially for all your speakers.
- Test Tone Level and Test Tone Frequency settings are global; even though the controls for the Test Tone Generator appear on several different menu screens, there is only a single Test Tone Generator which you are accessing from different places. Therefore, as you move from place to place in the menu system where the Test Tone Generator is used, the Test Tone Generator will remain set at the last Level and Frequency you select until you change it. When you exit the area of the menu where the Test Tone Generator is used, it will automatically switch Off.

Filter Level

For each filter, you can set the level from -64 dB to +6 dB in 0.5 dB increments.

Note: While it is not uncommon to have some overlap between EQ filters, or to have a narrow notch that falls inside a wider filter band where gain is applied, you should be careful about applying positive gain on overlapping filters; and avoid deliberately stacking multiple filters to create gain in excess of +6 dB. Although unlikely, it is possible, by applying excessive gain to overlapping bands, to cause the RMC-1 to clip.

Filter Width / Filter Q

For each filter, you can set the range of frequencies that it affects, from a fraction of an octave to several octaves. With the Filter Width control this range is expressed as a range of frequencies. The edges of the band are defined as the points where the filter is at 50% of its maximum effect - expressed in dB. For example, if a band is set to provide -10 dB of gain, then edges of that band are defined as the -5 dB points.) With the Filter Q control this range is expressed as the more traditional Q value. The values shown in these two fields refer to the same parameter and will move together, showing the same setting in both formats, when you adjust either control.

Note: You can adjust the width of each filter by changing the value in either the Q field or the field that shows the width of the band in Hz. However, while you are changing the value, only the number in the field you are using will change dynamically; the value in the other field will synchronize as soon as you exit the active field.

The RMC-1 Menu System

Filter Frequency

For each filter, you can set the center frequency of the band to any frequency between 20 Hz and 20 kHz, and the result will be displayed in Hz (or kHz).

Test Tone Level

The Test Tone Generator on the RMC-1 offers both pink noise and sine wave test tones at various frequencies for use in calibrating the parametric EQs. For each type of test tone you may select three different output levels: High, Medium, Low, and Off for use with external calibration signal sources.

Note: The actual sound pressure level your system will produce at each different output level setting will depend on many factors, including the gain of your amplifiers and the efficiency of your speakers. Always use common sense and select reasonable sound pressure levels at which to perform tests based on the results of your measurements.

There is only a single Tone Generator, even though the control appears in duplicate under the options for each filter.

If you select Off (External) as your test signal source, then whatever input source is currently selected on the RMC-1 will be used as the test tone source. This input will be treated as if it were playing in the equivalent of All Stereo Mode, but the resulting output signal will then be sent to *ONLY* the currently selected channel.

Test Tone Frequency

If you have selected sine wave test tones using Test Tone Level, then you can use the Test Tone Frequency control to set the output frequency of the sine wave test tone. There is only a single Tone Generator, even though the control appears in duplicate under the options for each filter. The Test Tone Generator output frequency can be set to any frequency between 20 Hz and 20 kHz, and the result will be displayed in Hz (or kHz).

Note: You may notice that the test tones are not absolutely pure continuous sine waves - and may include audible ticking noises at certain frequencies. While audible, these noises are simply artifacts of the program code used to generate the test tones; they do NOT significantly affect the energy distribution of the test tones, and have no significant effect on measurements performed using the test tones.

The RMC-1 Menu System

Import Filters

This option allows you to import sets of parametric EQ settings that you have previously saved, and to import correction filter settings exported by Room EQ Wizard or other third-party programs. Filter settings are stored in a set of XML files - one file for each channel, which are stored on a USB thumb drive, in a folder whose name corresponds to the Speaker Preset. When you Import Filters, all XML files in the appropriate preset folder on the USB thumb drive will be read, and the settings in each file present will replace the current settings for that Speaker Preset in your RMC-1. If only files corresponding to some channels are present, settings for those channels will be updated, and all other channels will remain unchanged.

See the Appendix entitled Importing and Exporting Parametric EQ Filters for more details, and for specific information about importing settings from Room EQ Wizard.

Export Filters

This option allows you to export the parametric EQ settings for the current Speaker Preset to a USB thumb drive as a set of XML files (these will be standard XML files with a .EMO extension).

See the Appendix entitled Importing and Exporting Parametric EQ Filters for more details.

Reset Filters

This option allows you to reset all the parametric EQ settings in the current Speaker Preset to their default values (flat).

The RMC-1 Menu System

Setup | Inputs Menu

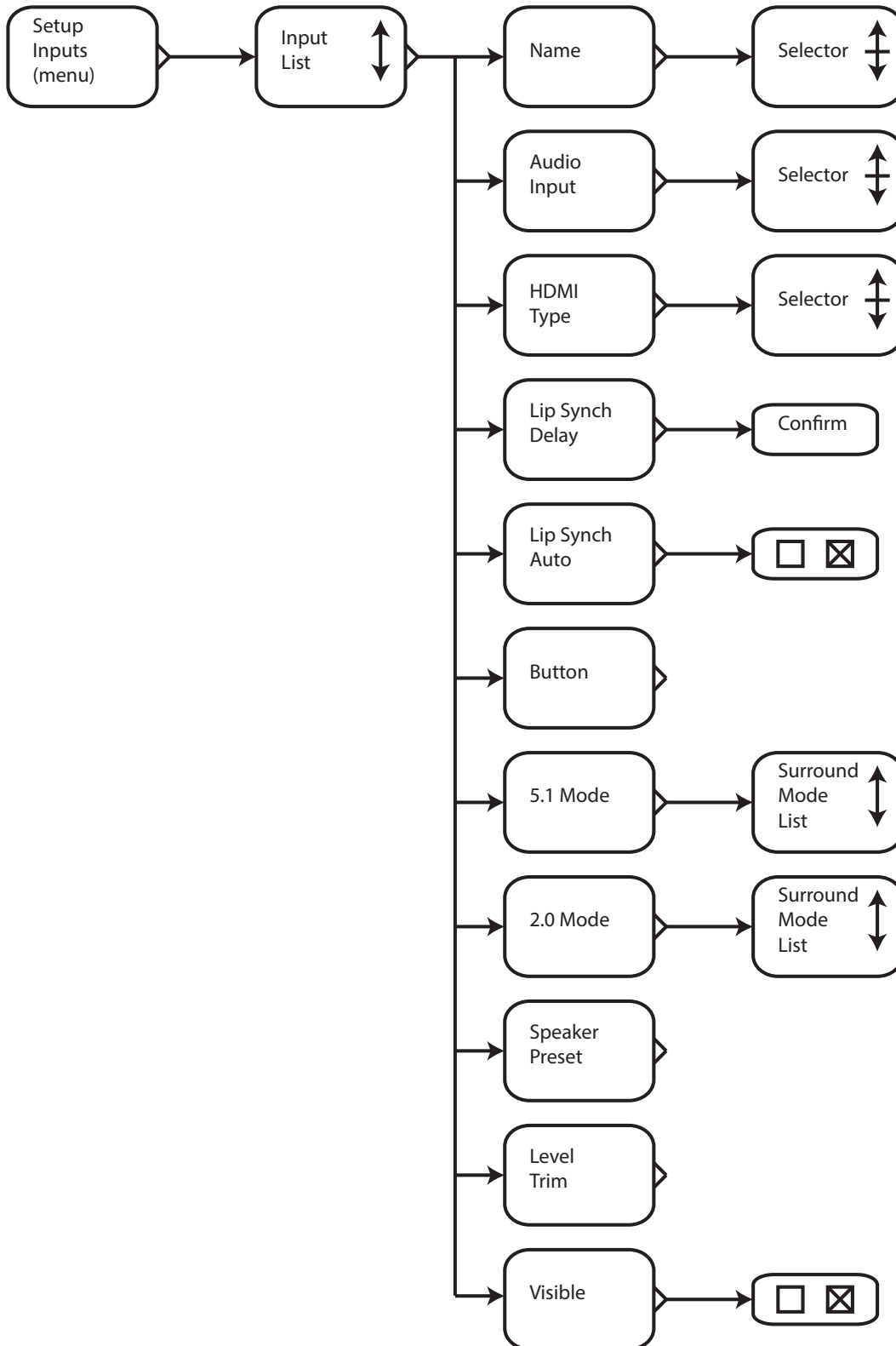

The RMC-1 Menu System

The **Setup Inputs Menu** allows you to independently set a Level Trim and various other parameters for each Input, and determine how that particular Input will handle each of several different types of input signals.

Note: Remember that the Input settings are independent for each Input, and so must be configured individually for each Input you use.

After selecting Setup Inputs you will be asked to select which Input you wish to configure. ALL of the following settings are available for EACH Input, and may be configured independently for each.

Note: When you enter the Setup Inputs Menu, the Input you are configuring will become the active Input and the RMC-1 will switch to it.

Name

The Name field allows you to configure an alphanumeric “human friendly” name for each Input.

Audio Input

By default, when an HDMI Input is selected, both audio and video signal are taken from that Input. This setting allows you to choose a different audio Input to be used with each HDMI Input.

Note: Normally, when using an HDMI Input, using that same Input for both your audio and video signal is preferred. However, there are two situations where that may not be true. Sometimes specific hardware compatibility issues may be avoided by choosing a non-standard audio Input. For example, if your cable box has issues with the audio it sends over its HDMI outputs, you may use this setting to tell the RMC-1 to take audio for that Input from a Coax digital or Toslink connection instead. Another possibility is that you may simply prefer to use a certain output - other than HDMI audio - with certain equipment. For example, if you have a Blu-Ray player with high-quality DACs, you may wish to allow it to decode and play the audio when you play discs on it. If so, then you would connect the analog outputs of your player to one of the analog inputs on the RMC-1, and use this setting to configure your RMC-1 to use audio from those analog Inputs with the video signal it receives via that HDMI Input.

Note: Because it concerns which audio signal is associated with a given video input signal, the Audio Input configuration option is ONLY available for HDMI Inputs.

HDMI Type

This option allows you to individually configure one or more inputs as HDMI 1.4 rather than HDMI 2.0 compatible. Even though HDMI 2.0 is supposed to be fully backwards compatible, we have found that not all legacy HDMI sources function properly when connected to an HDMI 2.0 input. This option allows you to configure specific inputs as “HDMI 1.4” for better compatibility with some legacy equipment.

Note: This option is intended to be used to minimize HDMI compatibility issues with some older legacy non-4k equipment. When a specific input on the RMC-1 is configured as HDMI 1.4, it will no longer support some HDMI 2.0 features, which may include the ability to play commercial 4k video content.

The RMC-1 Menu System

Lip Synch Auto

With most equipment, an HDMI connection includes the ability to automatically negotiate and set the correct Lip Synch Delay in most situations. Enable Lip Synch Auto to allow the RMC-1 to set the Lip Synch Delay automatically.

Note: The Lip Synch Auto option will only be available if your monitor provides information about its lip synch delay - otherwise this option will not appear.

Lip Synch Delay

The Lip Synch Delay setting is used to manually configure the Lip Synch Delay.

Note: The Lip Synch Delay is normally only configured manually if the automatic configuration fails to work properly with certain source equipment and/or a certain display or projector. If Lip Synch Auto is enabled, values you enter into the Lip Synch Delay are used to modify the values received from your monitor.

Button

The Button setting allows you to configure a direct access button for this Input (on the remote control and remote control apps).

None assigns no button to the Input.

1 - 8 assigns that button on the remote control to that Input.
(Only buttons 1 through 7 exist on the remote control.)

2.0 Mode & 5.1 Mode

The **2.0 Mode** setting determines what mode will be used by default when a two channel signal is received at this Input. The **5.1 Mode** setting determines what mode will be used by default when a surround sound signal is received at this Input. Setting these to Auto will instruct the RMC-1 to use the "best" option, based on your speaker configuration, and the incoming content - and is usually a good choice.

Note:

Only certain decoding options are available for each different type of input signal; the options you enter here instruct the RMC-1 of your preference for how certain types of inputs will be handled, but will only be used IF they are valid for the input signal currently being received.

For example....

- If the input signal is Dolby Atmos: the ONLY valid decoder mode for it is Dolby Atmos.

- If the input signal is DTS:X: the ONLY valid decoder mode for it is DTS:X.

(For both of those, your only options would be Direct, All Stereo, and Auto.

If you've selected Stereo, then, after being decoded, the results will be down-mixed to stereo.)

- If the Input signal is Dolby TrueHD, or DTS Digital, and you have chosen Surround as your default choice, then each will be decoded by the appropriate decoder, but no upmixing will be applied. (If the original is 5.1, and you have 7.1 speakers, it will simply play in 5.1).

The RMC-1 Menu System

- If the Input signal is Dolby TrueHD, and you have chosen Auto as your default choice, then the signal will be decoded into 5.1 by the Dolby TrueHD decoder. If you have 5.1 speakers it will play in 5.1. If you have 7.1 speakers, it will then be upmixed to 7.1 by the Dolby Surround Upmixer.

- If the Input signal is DTS Digital, and you have chosen Auto as your default choice, then the signal will be decoded into 5.1 by the DTS decoder. If you have 5.1 speakers it will play in 5.1. If you have 7.1 speakers, it will then be upmixed to 7.1 by the DTS Neural:X upmixer.

- If the incoming signal is two-channel PCM or analog, and you have chosen Direct, Stereo, or All Stereo, it will play as per your preference. Since both the Dolby Surround Upmixer and the DTS Neural:X upmixer are valid choices for a stereo input signal, if you have selected either of those as your default choice for 2.0 inputs, it will be used to upmix the input to 5.1 or 7.1 channels (to match your speaker configuration).

Speaker Preset

For each Input, you may select to apply any of the three separate speaker/room preset equalization curves provided by the RMC-1.

The **Dirac** preset is provided by the Dirac Live automatic room correction system; this curve is created when the Dirac software is run.

The other two presets (which will be named whatever name you assign to them when you create them) are created manually using the RMC-1's advanced parametric equalizer banks and controls. (See the Setup |Speakers and Setup | Speakers EQ sections for details.)

Level Trim

The Level Trim setting allows you to individually adjust the audio level for each Input. This is typically used to adjust the levels of each input to be similar. The Level Trim can be adjusted to anywhere between +/- 10 dB in 0.5 dB increments.

Visible

The **Visible** setting allows you to configure whether each Input appears when you scroll through the list of available Inputs. By setting Inputs you don't use to NOT Visible, you won't have to scroll past them when selecting an Input.

Note: The Visible setting only affects whether an Input will be skipped over when you switch Inputs using the Input Up and Input Down buttons. Even if you set an Input to Not Visible, you will still be able to access it using a button that you have assigned directly to it.

Connecting and Operating the RMC-1

Operating the RMC-1

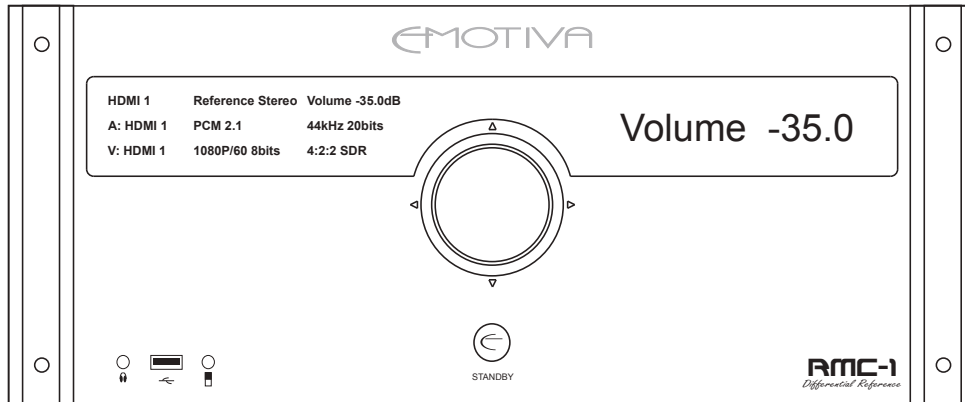

Connecting and Operating the RMC-1

RMC-1 Front Panel

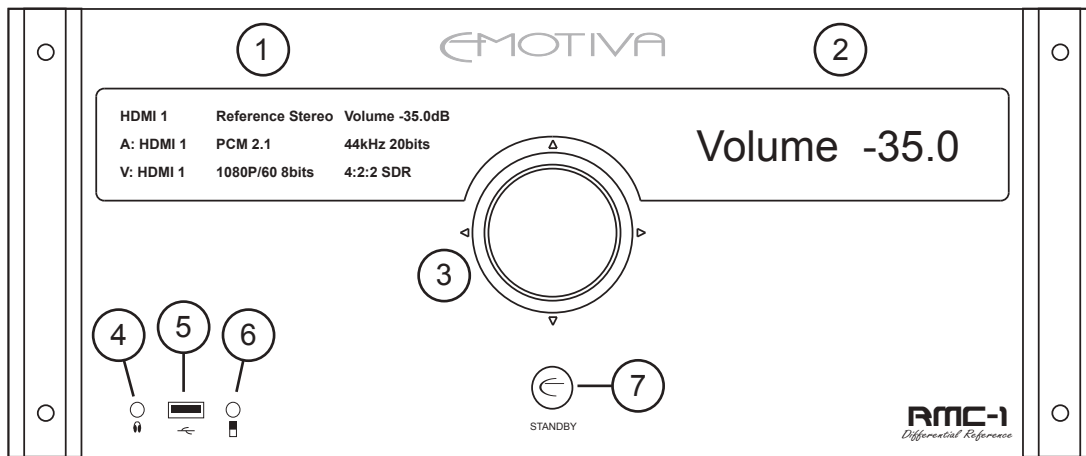

1. & 2. Left and Right Front Panel Status Displays

Large, bright, easy to read graphical 64 x 256 pixel blue OLED status displays. The information shown on each display can be customized in the Setup Menu.

3. Multi-Axis Encoder & Volume Control

The main control on the front panel of the RMC-1 is a unique multi-axis encoder, which combines a precision rotary encoder and a sensitive four-quadrant joystick type controller. When you are navigating the menu, highlight LEDs in the halo ring will illuminate to show which directions of controller movement access valid menu options.

Rotate this knob to control the output Volume on the RMC-1.

Press this knob momentarily to toggle the Mute function On and Off.

Press this knob and hold it for a few seconds to enter and exit the Menu.

Rock the knob, or press it to the side like a joystick (Up, Down, Left, or Right) to navigate the Menu.

4. Headphone Jack

Connect any standard pair of stereo headphones for high-quality personal listening. When you plug in a pair of headphones, the main outputs are automatically muted.

5. Front Panel USB Input

This input is used to apply firmware updates to the RMC-1 via a standard USB stick (thumb drive).

6. Front Panel Analog Input

Connect any music source that supplies line level stereo analog audio to this input. This input is named "Analog Front", and is typically used for an iPod or other portable music player.

Connecting and Operating the RMC-1

7. Standby Button

Press this to switch the RMC-1 from Standby to On; press it again to return the RMC-1 to Standby mode. (The rear panel AC Power switch must be On.) The halo ring around the Standby button illuminates amber for Standby and blue for On.

Note:

In its default configuration (Standby = Lowest Power), when the RMC-1 is powered on using the rear panel Power switch, the halo ring around the Standby button will immediately flash between amber and blue several times, then illuminate steady amber. Pressing the Standby button on the front panel, or the Standby button on the remote control, will then initiate the boot-up process. The Emotiva name will appear in one display, the halo ring around the Standby button will illuminate blue, the halo ring around the Encoder knob will pulsate blue, and a progress bar will move across the bottom of the display to indicate that the RMC-1 is booting up; the boot-up process will take about two minutes. When the boot-up process is complete, the halo ring around the Encoder knob and the halo ring around the Standby button will illuminate steady blue, and both displays will become active, displaying the status information they were configured to display in the Setup Menu. Pressing the front panel Standby button, or the Standby button on the remote control while the RMC-1 is On, will return the RMC-1 to Standby mode; in Standby Mode, only the halo ring around the front panel Standby button will remain illuminated amber.

In the High-Power Standby mode (Standby = Video Remains On), when the RMC-1 is powered on using the rear panel Power switch, the halo ring around the Standby button will immediately flash blue several times, then illuminate steady blue. The Emotiva name will appear in one display, the halo ring around the Encoder knob will pulsate blue, and a progress bar will move across the bottom of the display to indicate that the RMC-1 is booting up; the boot-up process will take about two minutes. Once the boot-up process is complete, the RMC-1 will return to Standby mode; with only the halo ring around the front panel Standby button illuminated amber. At this point, pressing the front panel Standby button, or the ON button on the remote control, will switch the RMC-1 fully On, the halo ring around the Encoder knob and the halo ring around the Standby button will illuminate steady blue, and both displays will become active, displaying the status information they were configured to display in the Setup Menu. Pressing the front panel Standby button or the Standby button on the remote control when the RMC-1 is On will then return it to Standby mode.

Note:

The Setup Menu, the Front Panel controls, and the remote control, can all be locked out from inside the Setup | Advanced Menu. You may wish to lock the Front Panel controls if you never use them, and you may wish to lock the Front Panel controls or the Setup Menu to avoid unauthorized or unintentional operation or changes to the RMC-1's configuration.

If you become locked out of your RMC-1, you can override one or both of these locks by PRESSING THE STANDBY BUTTON ON THE FRONT PANEL WHILE CONTINUING TO PRESS THE CONTROLLER KNOB. If you do this, you will be granted temporary access to the Setup Menu, where you can then access the Setup | Advanced Menu and disable one or more of the locks.

Connecting and Operating the RMC-1

RMC-1 Rear Panel

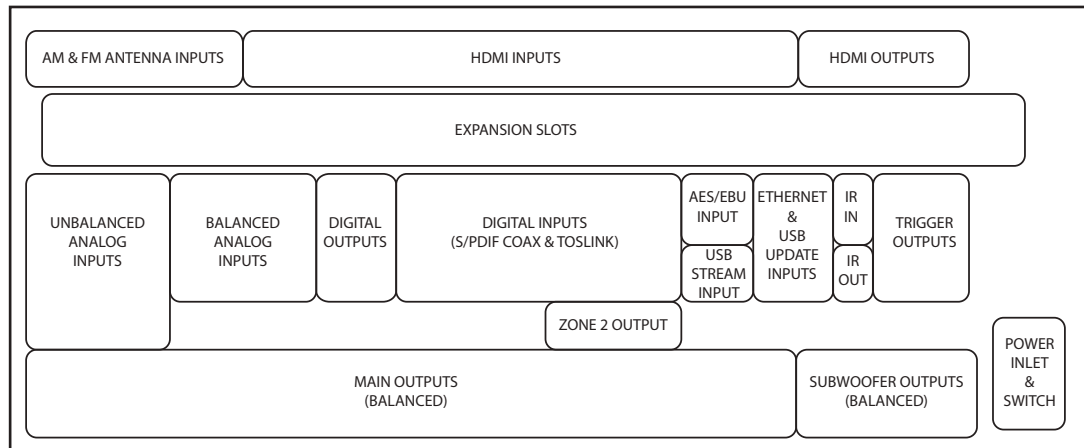
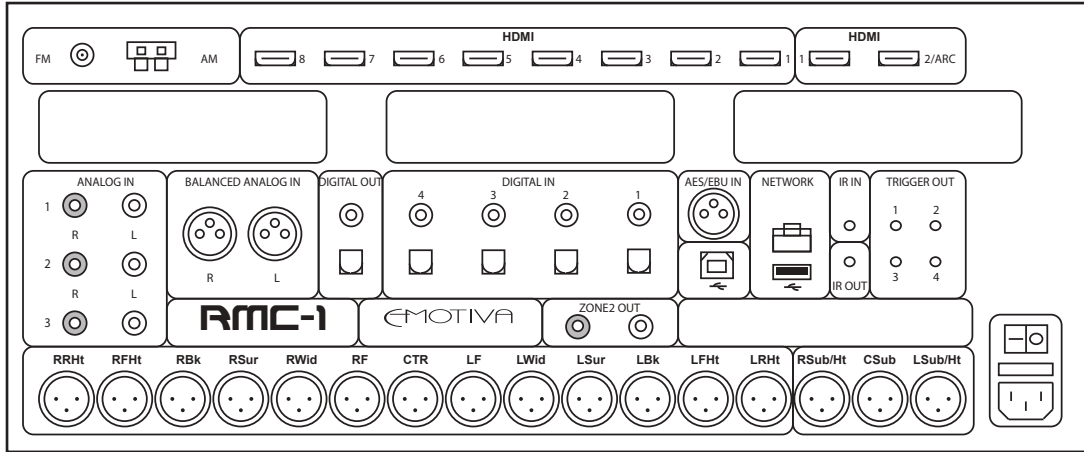

Connecting and Operating the RMC-1

Rear Panel - Video Inputs and Outputs (HDMI)

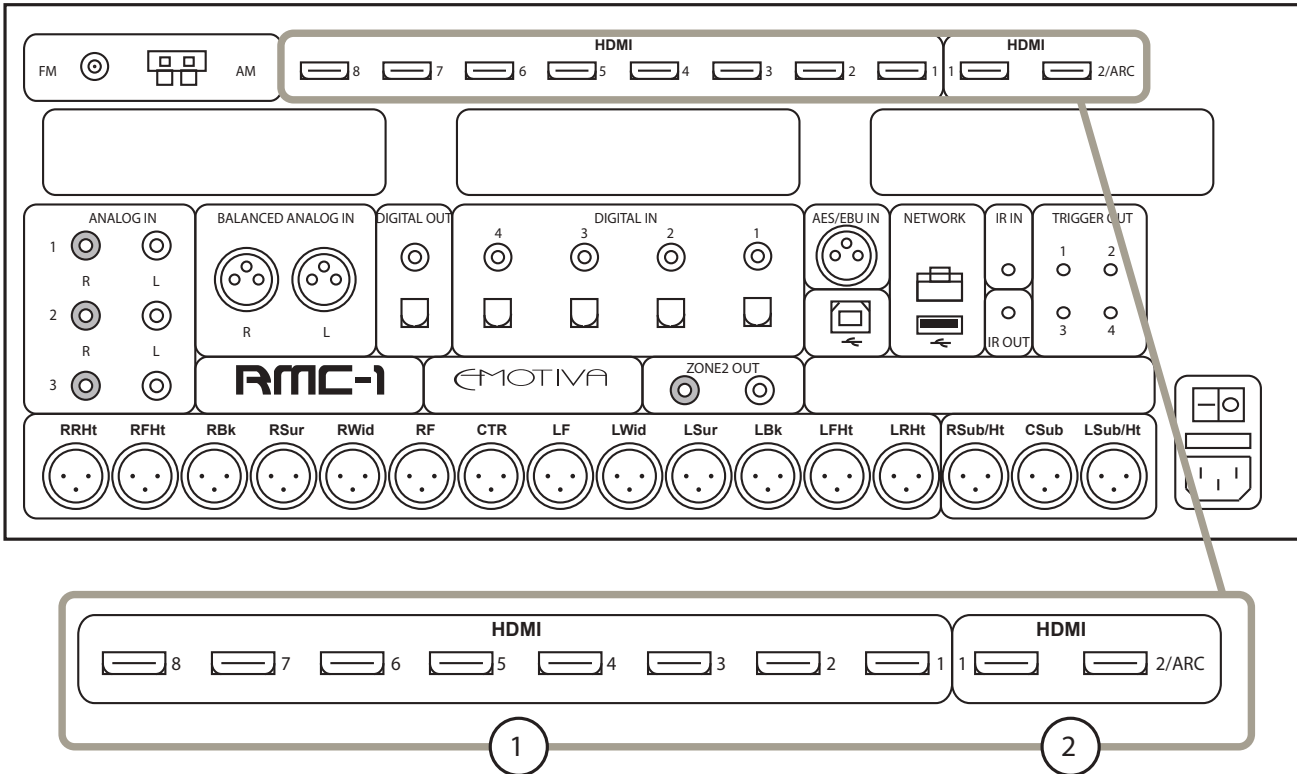

1. HDMI Inputs (8)

Provide eight inputs for components that have HDMI outputs. All eight HDMI inputs are identical, and are HDMI 2.0b and HDCP 2.2 compliant.

2. HDMI Outputs (2)

Each HDMI output is HDMI 2.0b and HDCP 2.2.

HDMI Output 2 is considered to be the primary output, and is both ARC and CEC enabled.

Connecting and Operating the RMC-1

Rear Panel - Analog Audio Inputs

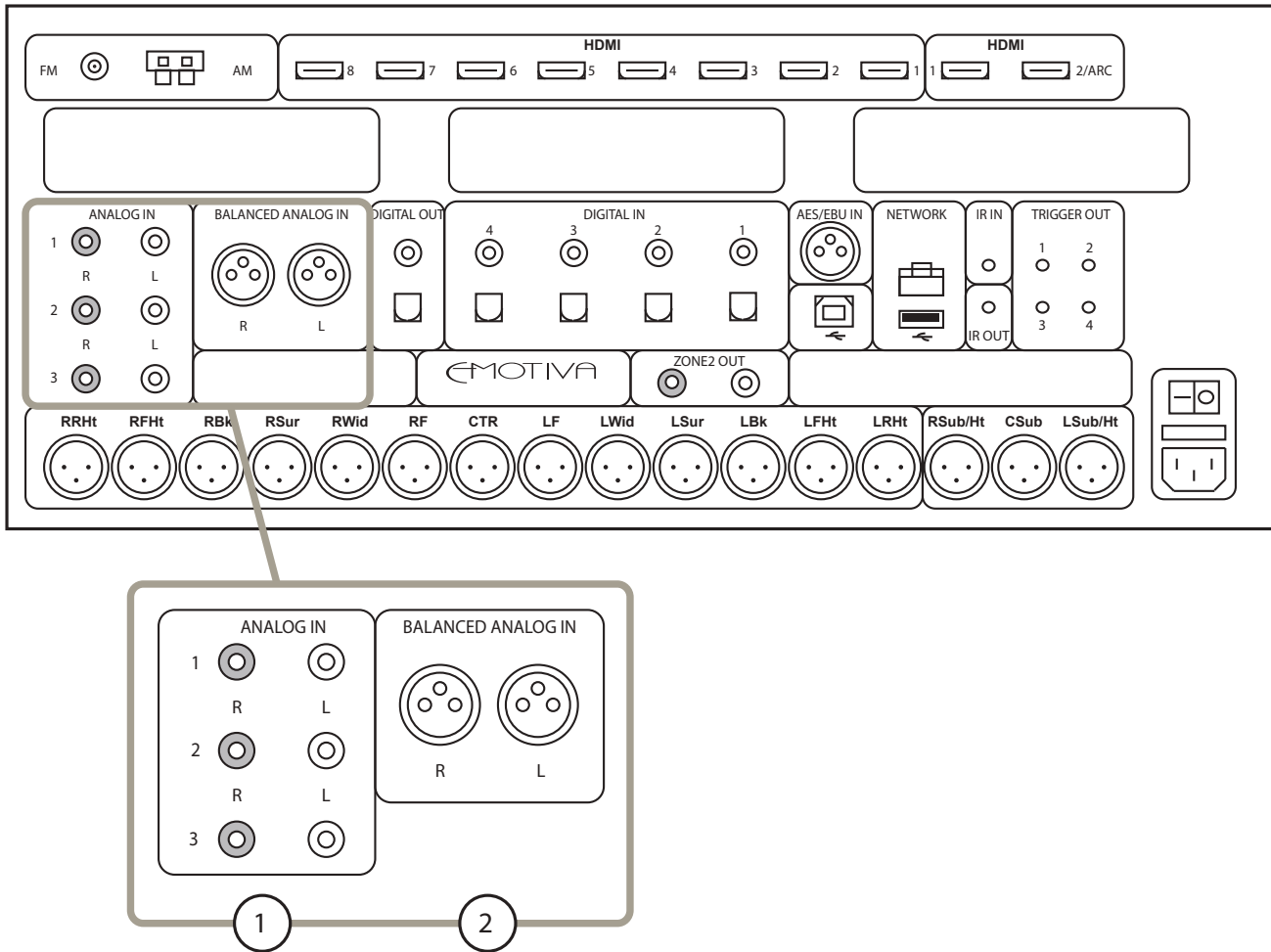

1. Stereo Unbalanced Analog Audio Inputs (3 pairs)

Provide inputs for three unbalanced stereo analog sources.

2. Stereo Balanced Analog Audio Inputs (1 pair)

Provides an input for one balanced analog source.

Connecting and Operating the RMC-1

Rear Panel - Main Analog Audio Output

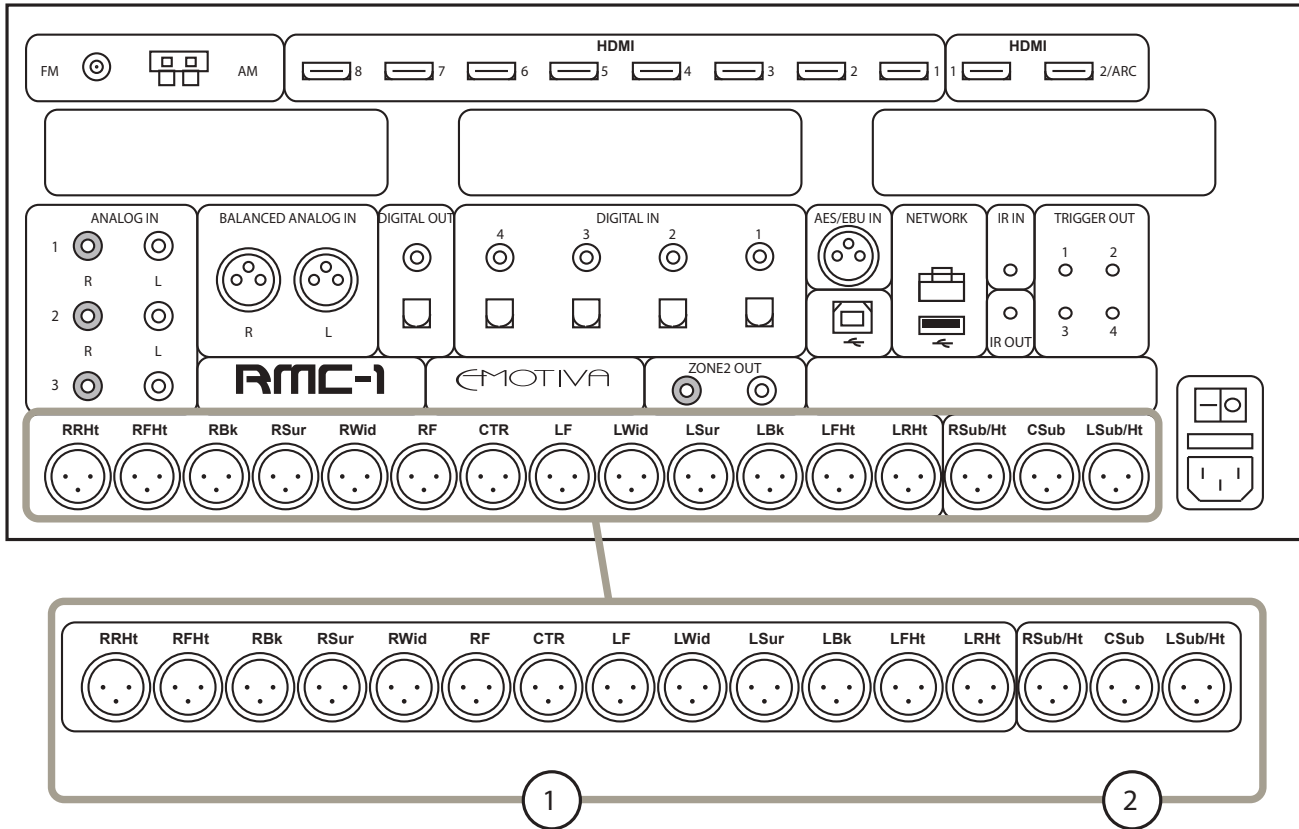

1. Main Audio Outputs (balanced)

Connect these line level outputs to one or more external power amplifiers.

Note: All of the analog audio outputs on the RMC-1 offer balanced XLR connections. Many modern high quality power amplifiers offer balanced input connections. The balanced input is preferred for any amplifier that offers both types of inputs. If one or more of your amplifiers offers only unbalanced inputs, then a set of standard low-cost balanced-to-unbalanced adapters can be used to allow you to connect unbalanced RCA interconnect cables to the RMC-1, or you can purchase adapter cables with a balanced XLR connector on one end and an unbalanced RCA connector on the other.

2. Subwoofer/Height Outputs (balanced)

Connect a single subwoofer to the Center Subwoofer output.

The other two Subwoofer outputs may be used to connect either two more subwoofers, or a pair of Center Height speakers, depending on how they are configured in the Setup Menu.

Note: The RMC-1 supports up to three subwoofers; each of which receives the same monaural LFE and low frequency content. The left, right, and center designations are provided strictly to aid in identifying each subwoofer by connection and room location.

Connecting and Operating the RMC-1

Rear Panel - Zone 2 Outputs

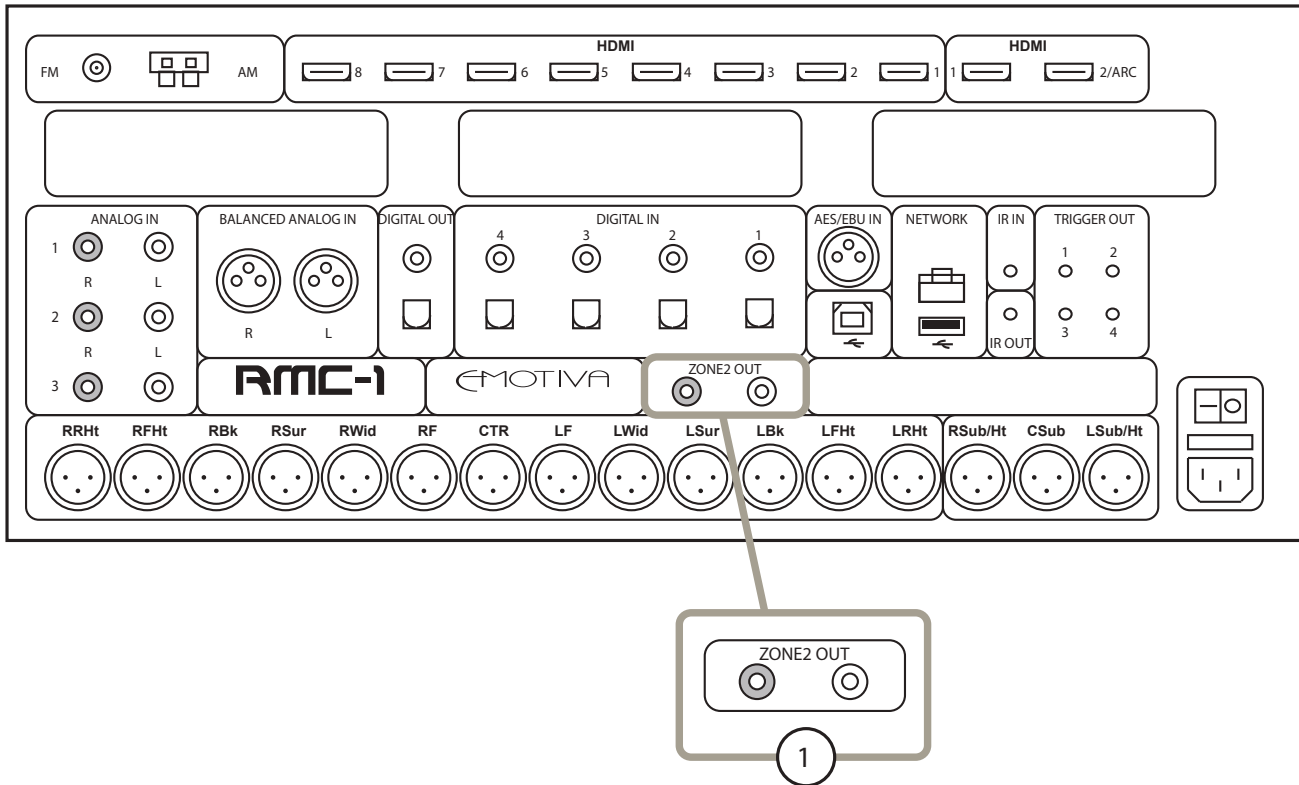

1. Zone 2 Audio Output

Provide a stereo unbalanced line level analog audio output for Zone 2.

Note: The RMC-1 supports two audio zones, the Main Zone and Zone 2.

Note: On the RMC-1, the Zone 2 source may be selected independently from the Main Zone source. If you select Follow Main as your Input for Zone 2, then Zone 2 will play whatever is playing in the Main Zone - with no restrictions. If you prefer to have Zone 2 play content from a different source, you will be able to select ANALOG sources, and 2 CHANNEL PCM DIGITAL sources connected to Optical or Coax digital inputs. You will NOT be able to select a different digital surround sound or HDMI source for Zone 2 than what is selected for the Main Zone. If a source that provides a surround sound signal is selected, the Zone 2 Output will deliver a Mixed-Down Stereo version of it.

Connecting and Operating the RMC-1

Rear Panel - Digital Audio Inputs and Outputs

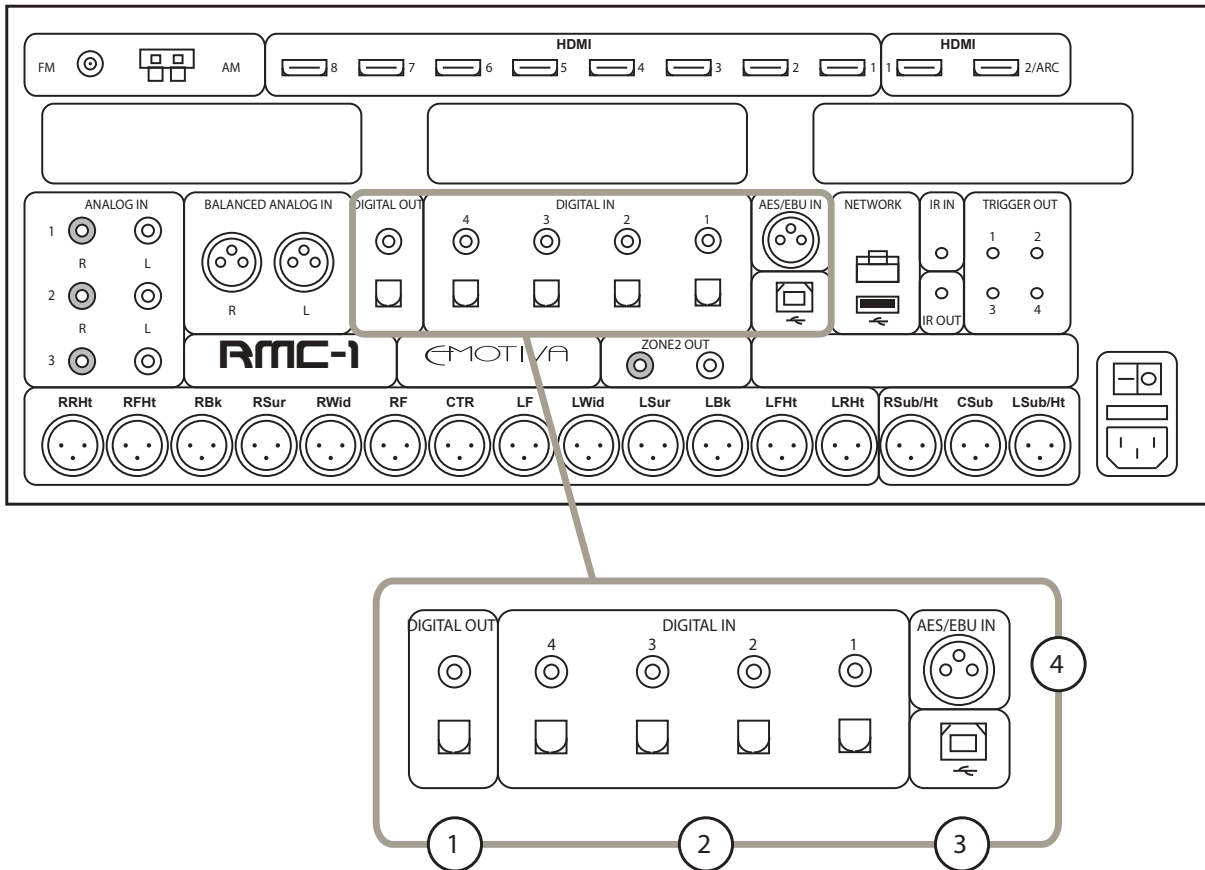

1. Digital Audio Outputs

Connect these outputs to the digital inputs of an external audio device or DAC.

Note: The Digital Audio Outputs of the RMC-1 are subject to processing, and/or re-sampling or sample rate conversion in some instances. They are intended for connecting other external devices with their own digital inputs, but should not be considered to be bit-perfect copies of the digital input signal.

2. & 4. Digital Audio Inputs

The RMC-1 provides ten digital audio inputs, designated Coaxial 1, Coaxial 2, Coaxial 3, Coaxial 4, Optical 1, Optical 2, Optical 3, Optical 4, and AES/EBU.

Connecting and Operating the RMC-1

4. USB Stream Input

Use this input to connect a computer or other compatible media client to the RMC-1.

The RMC-1 will appear as a USB audio device (sound card or speaker) to a computer that is connected to this input. This input supports all standard sample rates between 44.1k and 384k, and DoP (DSD-over-PCM) at both standard and double rates.

Note: The USB Stream input can be configured as a USB Audio Class 1 (UAC1) or USB Audio Class 2 (UAC2) device. Almost all devices that offer a USB audio output support UAC1 - but UAC1 is usually limited to 24/96k. Modern Apple computers, recent Windows 10 computers, and many Linux computers and Android phones, support UAC2 - which is capable of higher sample rates - at least up to 24/384k. However, older Windows computers will require a separate driver download to support UAC2. The USB Stream input currently supports PCM audio up to 24/192k. Future enhancements will expand that to include higher sample rates and DSD via USB (using DoP).

Connecting and Operating the RMC-1

Rear Panel - Infrared (IR) Remote Input and Output

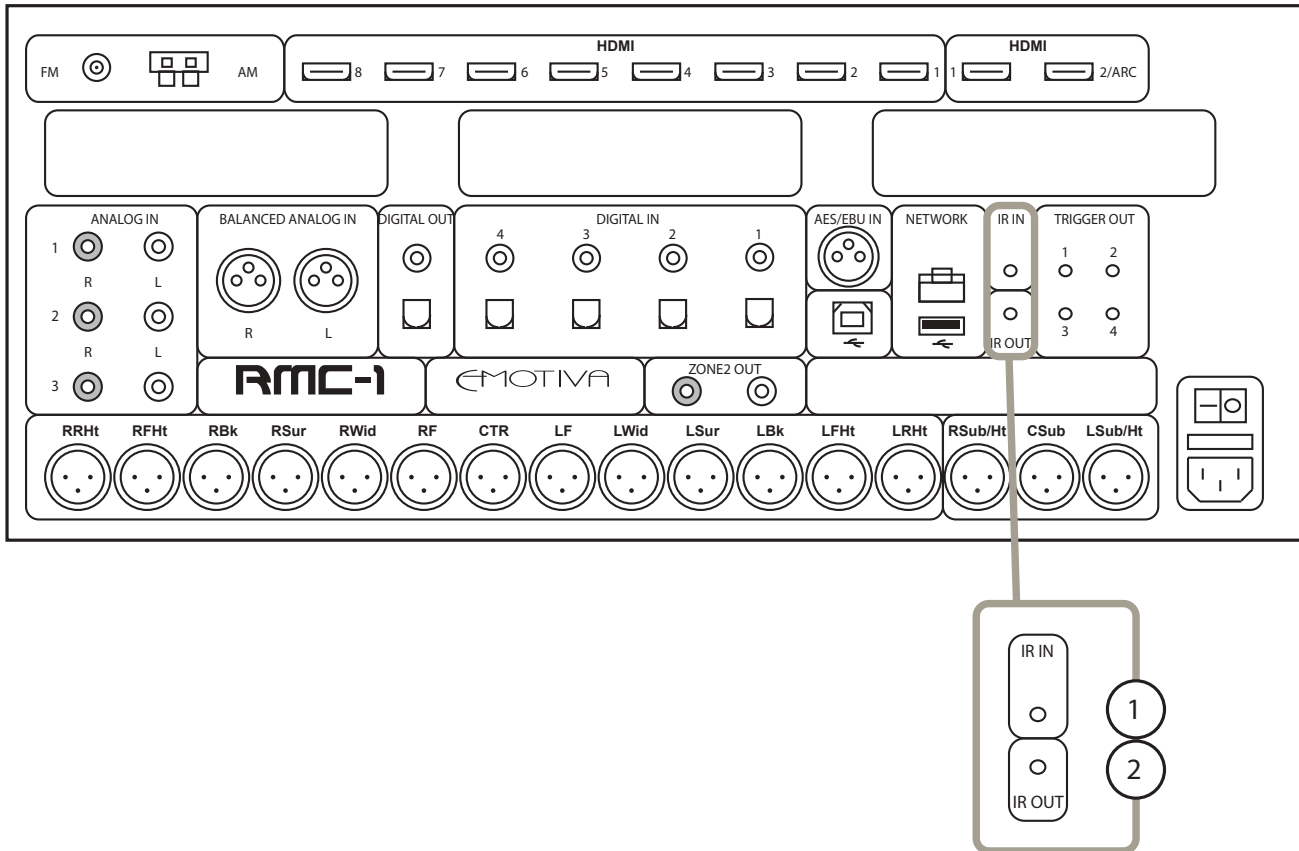

1. & 2. IR Remote Input and Output

Connect a remote IR detector (eye) to this input. This is especially useful if your RMC-1 is located in a cabinet or other area where the front panel IR detector is blocked. Connect a remote IR transmitter (“blaster”) to this output to control other equipment.

Note: When the RMC-1 is On or in Standby, it always “listens” for IR remote control codes. If configured to do so, the RMC-1 can accept remote control codes intended for other devices via its front panel and remote IR inputs, and relay remote control codes intended for other devices via its IR remote control outputs. Because this capability is always active, the Standby button on the RMC-1 will flicker to indicate that it is receiving remote control codes when you operate IR remote controls for OTHER devices within range of its sensors; this is normal.

Note: The IR In port on the RMC-1 must be connected to a powered IR detector - or “eye”. (Appropriate IR detectors include a small circuitry module that provides a buffered output signal. In many cases, you will connect the RMC-1 to the output which is intended for connection to an IR “flasher” or “repeater”.)

Connecting and Operating the RMC-1

Rear Panel - Trigger Outputs

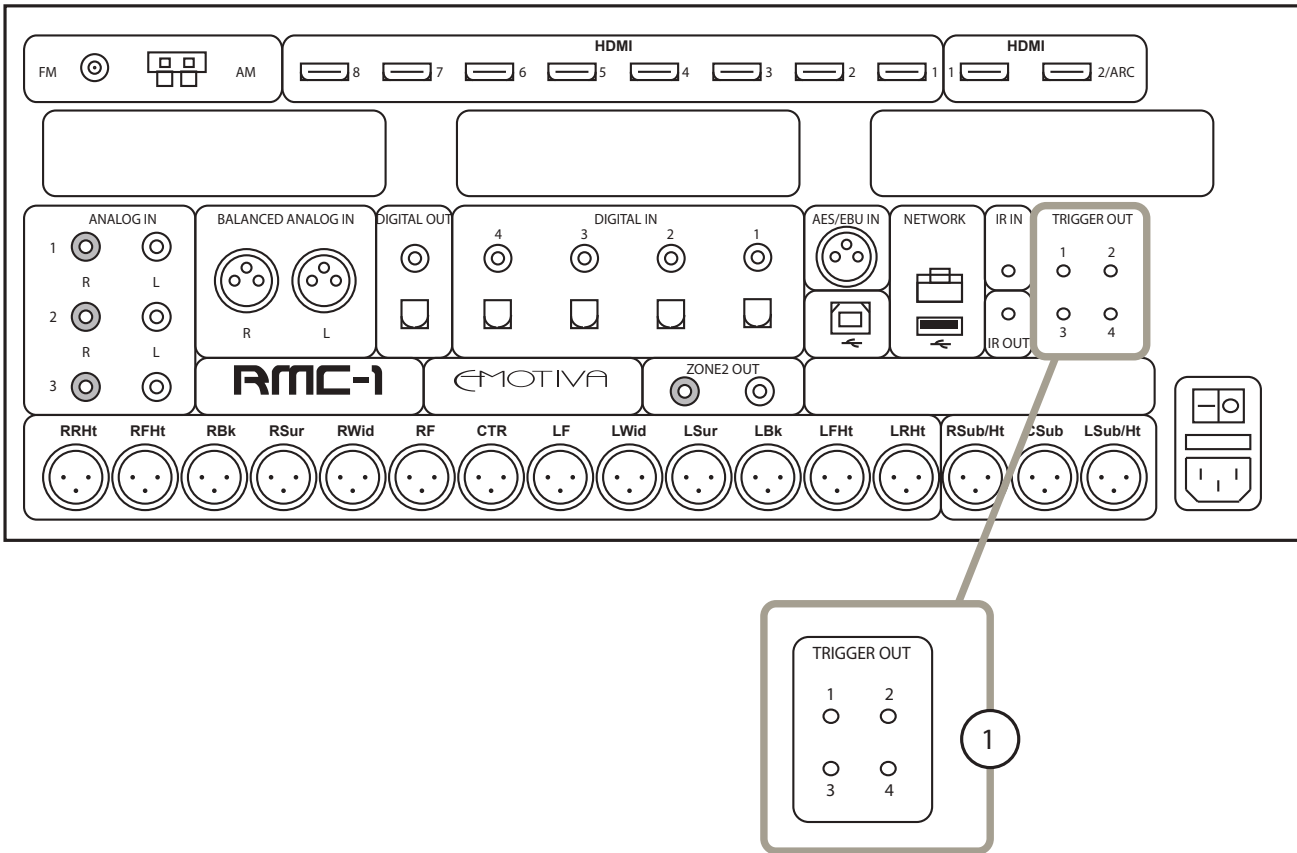

1. Trigger Outputs (4)

Connect each Trigger Output to one piece of trigger-enabled audio equipment. You can then configure the RMC-1 to turn on specific trigger-enabled equipment when specific input sources or modes are selected.

Connecting and Operating the RMC-1

Rear Panel - Power Switch, IEC Receptacle, and Fuse Holder

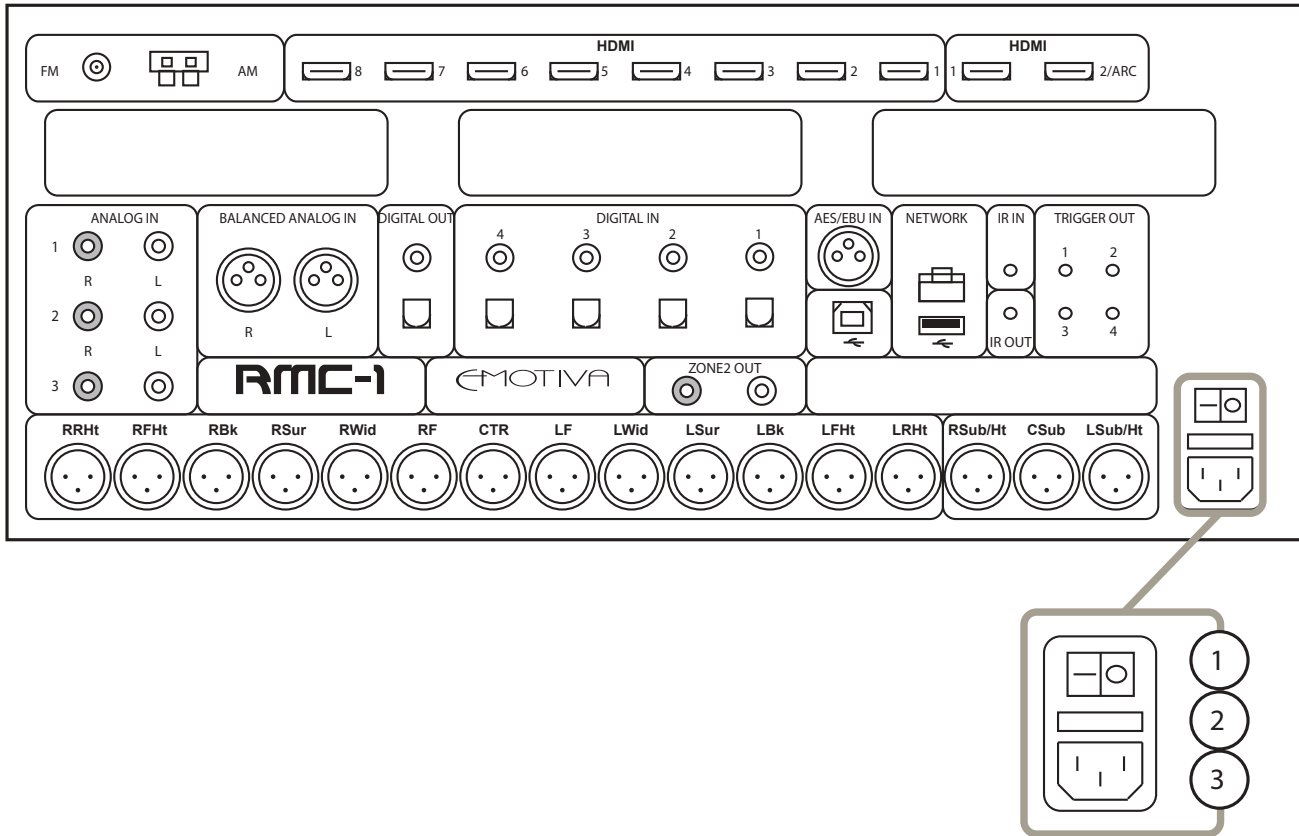

1. Main AC Power Switch

Switches the AC main power to the RMC-1 On and Off. When this switch is Off, the RMC-1 will not respond to trigger signals or manual controls.

2. Fuse Holder

This fuse holder holds the RMC-1's main system AC fuse. See the section entitled Fuses for details about how to check this fuse, and change it if necessary.

3. Standard IEC Power Inlet

The RMC-1 can be used with either a two-wire or three-wire standard IEC power cable.

Connecting and Operating the RMC-1

XMC-2 Remote Control

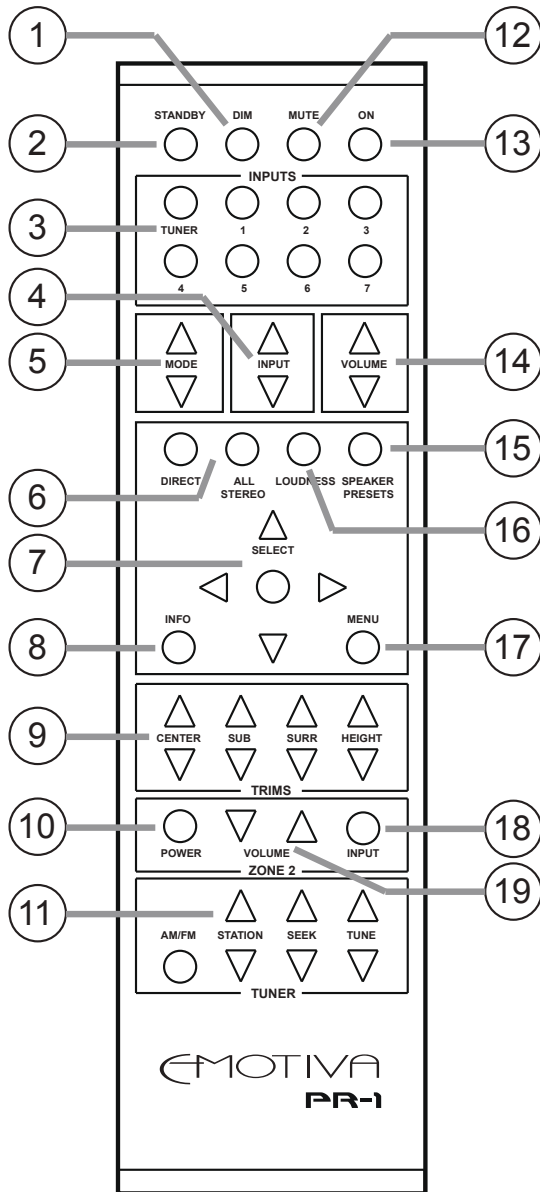

1. Dim Button

Press the Dim button once to display the current Brightness setting; then, press the button repeatedly to adjust the Brightness setting of the RMC-1 front panel display; each subsequent press advances the Brightness one level; if the Brightness is at 100%, the next button press returns it to 0%. (Brightness can be adjusted in six steps: 0%, 20%, 40%, 60%, 80%, 100%).

2. Standby Button

Press the Standby button to switch the RMC-1 from On to Standby mode.

3. Direct Input Selector Buttons

Press one of the Direct Input Selector buttons to switch the RMC-1 directly to a specific input.

Note: Buttons are assigned to specific inputs using the Setup Menu.

4. Input Selector Buttons

Use the Input Selector buttons to cycle through the entire list of available inputs on the RMC-1.

Note: Only Inputs configured as Visible on the Setup Inputs Menu will be shown here.

5. Mode Selector Buttons

Use the Mode Selector buttons to cycle through the available modes for the input you have selected.

Note: The Mode Selector buttons will only allow you to select modes that are valid for the particular input and source content you have selected. When playing DVD and Blu-Ray discs, your player and the disc itself may offer a choice of several audio modes. After you select this output audio format, the RMC-1 will determine which type of audio is being supplied by your source component, and will ONLY allow you to choose audio modes that are compatible with that input signal.

Connecting and Operating the RMC-1

6. Direct Mode & All Stereo Mode

Press one of these buttons to switch the RMC-1 into Direct Mode or All Stereo Mode without cycling through the available choices on the menu.

7. Menu Navigation Buttons

Use the Select Button (center), and the Up, Down, Left, and Right buttons for navigating the front panel and on-screen menus.

8. Info Button

If the Info screen is already displayed on the RMC-1 front panel display, pressing the Info button will cause the Info screen to display momentarily on the OSD. If the Menu screen is displayed on the RMC-1 front panel, pressing the Info button will cause the Info screen to display momentarily on both the front panel display and the OSD (you will be returned to the Menu screen when the Info screen times out).

9. Trims Adjustments

Use the Trims Adjustment buttons to temporarily adjust the levels on specific sets of speakers. The Surround buttons act equally on all surround channels currently configured; the Height buttons act equally on all height channels currently configured.

Note: These Trims are used to make temporary adjustments to speaker levels; for example, to adjust the levels for a particular movie or disc. Since these settings are intended to be temporary, they are NOT retained when you switch Inputs or change Speaker Presets, and they are NOT retained when the RMC-1 is restarted. To make changes to speaker levels which will be retained, use the Levels settings in the Speakers Preset section of the Setup Menu.

10. Zone 2 Power Button

Use the Zone 2 Power button to turn Zone 2 On and Off. Pressing this button once turns Zone 2 On; pressing it again turns Zone 2 Off.

Note: Pressing the Zone 2 Power button will turn Zone 2 On, even if the RMC-1 is in Standby mode, and even if the RMC-1 is configured to use its Lowest Power Standby mode. However, if you turn on Zone 2 while the Main Zone is Off, and while the RMC-1 is in Lowest Power Standby mode, there will be a delay while the RMC-1's operating system is loaded. You can avoid this delay by configuring your RMC-1 to use Video On Standby mode.

11. Tuner Control Buttons

Note: Once you have used the Tuner Direct Input button to select the RMC-1 tuner, the Tuner Control buttons control operation of the tuner.

Press the AM/FM button to toggle between the AM and FM bands. Press the Station Up or Station Down button to move to the previous/next preset station. Press the Seek Up or Seek Down button to instruct the RMC-1 to seek to the previous/next received station. Press or hold the Tune Up or Tune Down button to instruct the RMC-1 to manually seek a station by tuning up or down the frequency band.

Connecting and Operating the RMC-1

12. Mute Button

Press the Mute button to mute the audio output on the RMC-1; press it again to unmute the audio.

13. On Button

Press the On button to switch the RMC-1 from Standby mode to On.

14. Volume Up and Volume Down Buttons

Use the Volume Up and Volume Down buttons to raise and lower the audio volume on the RMC-1.

Note: Audio level on the RMC-1 is controlled by an electronic digitally controlled analog ladder network. When you change the Volume using the buttons on the remote control, the Volume knob will not move.

15. Speaker Preset Button

Toggles between the speaker presets: Dirac Live, and the two manual presets, which will show the names you have configured for them.

16. Loudness Button

Press this button to configure the Level Controls on the RMC-1 to act as a true Fletcher-Munson Loudness control; press it again to configure the RMC-1 Level Controls as a standard audio Volume control.

17. Menu Button

Press this button enter the RMC-1 Menu system; press it again to close the Menu and return to normal operation.

18. Zone 2 Input Button

Use the Zone 2 Input button to cycle between the available inputs for Zone 2.

Note: On the RMC-1, the Zone 2 input is selected independently from the main zone. ANY input that is currently selected as the Main Zone Input can also be selected as the Zone 2 Input. If you wish to set the Zone 2 Input to a different source than the main zone, you will be able to select both ANALOG sources and 2 CHANNEL PCM DIGITAL SOURCES. You will NOT be able to select a different digital surround sound or HDMI source for the Zone 2 Input that is different than what is playing in the Main Zone.

19. Zone 2 Volume Button

Use these buttons to raise and lower the volume of the Zone 2 audio outputs.

Connecting and Operating the RMC-1

Using The USB Stream Input (the Computer/DAC Input)

Use this input to connect a computer or other compatible media client to the RMC-1.

The RMC-1 will appear as a USB audio device (sound card or speaker) to a computer that is connected to this input. This input supports all standard sample rates between 44.1k and 384k, and DoP (DSD-over-PCM) at both standard and double rates.

Note: The USB Stream input can be configured as a USB Audio Class 1 (UAC1) or USB Audio Class 2 (UAC2) device. Almost all devices that offer a USB audio output support UAC1 - but UAC1 is usually limited to 24/96k. Modern Apple computers, recent Windows 10 computers, and many Linux computers and Android phones, support UAC2 - which is capable of higher sample rates - at least up to 24/384k. However, older Windows computers will require a separate driver download to support UAC2. The USB Stream input currently supports PCM audio up to 24/192k. Future enhancements will expand that to include higher sample rates and DSD via USB (using DoP).

Care and Maintenance

Periodic Maintenance

Your Emotiva RMC-1 requires no periodic maintenance or calibration.

Cleaning your RMC-1

- If necessary, the RMC-1 should be cleaned gently with a soft rag.
- If something sticky gets on the front panel or case of the RMC-1, it should be cleaned with a mild cleaning solution applied to a soft rag, followed by wiping with a clean rag dampened with plain water and drying with a soft dry rag or cloth.

Note: DO NOT spray water or cleaning solution directly onto the RMC-1 or into the vents.

- If something sticky gets on the remote control, it should be cleaned with a mild cleaning solution applied to a soft rag, followed by wiping with a clean rag dampened with plain water and drying with a soft dry rag or cloth.

Note: DO NOT submerge the remote control in liquid or spray water or cleaning solution directly onto it.

Fuses

The RMC-1 has three fuses that protect it from power surges and other fault conditions.

- A blown fuse does not necessarily indicate a problem; fuses may blow for many reasons, including a power surge in your AC line, or a fault with your RMC-1.
- If a fuse blows, **ALWAYS REPLACE IT WITH ONE OF THE SAME SIZE, RATING, AND TYPE; NEVER USE A FUSE OF HIGHER RATING.**
- If one or more fuses blows repeatedly **CONTACT EMOTIVA TECHNICAL SUPPORT.**

The main AC power fuse for the RMC-1 is located in the IEC power cable receptacle, behind the small plastic panel with the picture of a fuse on it, and is easily accessible without removing the top cover. In addition, there are two power supply fuses located on the power supply board inside the RMC-1.

If you suspect that a fuse is blown, remove the fuse and test it with an ohmmeter or low-current continuity tester. If the fuse measures more than a few ohms of resistance, shows “no continuity”, or is obviously cracked or scorched, then it should be replaced.

Note: Always use a modern continuity tester or resistance meter to check fuses. Some older flashlight style continuity testers deliver enough current to blow a low-value fuse, and so should be avoided.

Care and Maintenance

Changing the Main AC Power Fuse

To test or change the main AC power fuse, do the following:

- Unplug the AC power cord from the IEC receptacle on the rear panel of the RMC-1.
- Carefully pry up the small plastic panel with the picture of a fuse on it - located adjacent to the power cable opening. The panel should snap, then slide straight out like a drawer.
- Test the fuse, and replace it if it tests “bad”, or if it is obviously cracked or charred.
- Carefully replace the fuse holder. The little tab on the panel should face towards the power cable cutout. Make sure you have it facing the right way, and that you snap it firmly in place.

Note: The fuse should fit quite loosely in the small plastic clip in the side of the fuse holder. It will engage the electrical fuse contacts tightly when the panel is in its closed position. The fuse holder itself snaps quite firmly into position, and should sit flush when properly inserted.

Changing the Internal Power Supply Fuses

The power supply fuses on the RMC-1 are located on the power supply board, which is located inside the RMC-1, mounted to the bottom of the chassis, towards the front of the unit. To access the power supply board, you will need to remove the outside top cover of the RMC-1.

To test or change the power supply fuses, do the following:

- Unplug the AC power cable from the RMC-1.
- Allow the RMC-1 to sit unplugged for ten minutes to discharge the power supply.
- You will need access to the top, sides, back, and bottom of the RMC-1, so move it to a location where you have room to work, and be sure to place it on a soft or padded surface to avoid scratching the finish; a clear area on a carpeted floor will work fine.
- Remove and carefully set aside the eight screws securing the top panel to the RMC-1 (three on each side, and two on the rear panel, all near the top edge of the RMC-1).
- Remove and carefully set aside the top cover.
- You should now see the two power supply fuses, located on the top of the power supply board (near the front of the RMC-1).
- Test each fuse, and replace it if it tests “bad”, or if it is obviously cracked or charred.

To close your RMC-1 back up for use after testing or changing the internal fuses, do the following:

- Replace the top panel of the RMC-1, and replace the eight screws securing it.
- Replace the power cable.
- It’s a good idea to confirm that your RMC-1 is now working before replacing it in your equipment rack and reconnecting it.

Changing Remote Control Batteries

Emotiva recommends using high quality Alkaline or Lithium "N-cell" batteries in the RMC-1 remote control.

Installing the Remote Control Batteries

The back plate of the RMC-1 remote control is attached by magnets. To remove it, simply insert a small screwdriver into the slot on the back plate - toward the bottom - and pry gently.

To install batteries:

- Remove the back plate of the remote control.
- Locate the battery holder.
- Carefully insert the two batteries into the battery holder. The negative end of each battery should face the pressure spring in each section of the battery clip.
- Replace the back plate (the slot should be toward the bottom end of the remote control and the small metal loop next to the slot should be on the inside when the back is in place.)

Your remote control is now ready to use.

Note: Your RMC-1 may arrive with the batteries packaged separately, or the remote control may arrive with batteries already installed, but with a small insulator installed between one battery and the battery contact to prevent the batteries from discharging in shipping. If so, then simply follow the instructions for opening the remote control, and pull out the small insulator strip that is inserted between the end of the battery and the battery contact, before using your remote control.

Replacing the Remote Control Batteries

- Remove the back plate of the remote control.
- Locate the battery holder.
- Note the direction in which the batteries are installed in the holder.
- Remove the depleted batteries and dispose of them in accordance with the manufacturer's recommendations.
- Insert new batteries, taking care to insert them in the same orientation (facing the same way) as the original batteries.
- Replace the back plate (the slot should be toward the bottom end of the remote control and the small metal loop next to the slot should be on the inside when the back is in place.)

Your remote control is now ready to use.

Care and Maintenance

Updating the RMC-1 Firmware

The firmware update is installed from a standard USB flash drive. The update consists of a single file, which may be downloaded and written to a USB drive, or may be provided on a pre-recorded flash drive.

Note: If you download the firmware update file, it can be written to most standard USB drives. The USB drive you use should be at least 500 mB in size, and should be formatted using a standard FAT32 format; avoid multiple partitions or drives with permanently installed management software, and place the file in the main folder on the drive. Either a USB drive formatted on a Windows computer or a pre-formatted USB drive should work, and the file may be downloaded using either a Windows or Apple computer, but USB drives formatted on Apple computers using the default settings may not work.

Note: ALWAYS erase any previous RMC-1 update files from the USB drive before copying new ones to it - having multiple different firmware update files in the main folder of the same drive may result in unpredictable behavior.

Note: It is perfectly acceptable to use the same USB drive for a firmware update file and a configuration backup.

To update the RMC-1 firmware:

- If necessary, copy the RMC-1 firmware update file onto a standard FAT32 formatted USB flash drive. See the above Notes for details.
- Insert the USB drive into the USB port on the front or back of the RMC-1.
- Press the Menu button.
- Use the Up/Down buttons to select Setup; press the Right button to enter the Setup menu.
- Use the Up/Down buttons to select Advanced; press the Right button to enter the Advanced Setup menu.
- Use the Up/Down buttons to select Firmware Update; press the Right button to enter the confirmation screen.
- Use the Up button to confirm your choice; the confirmation box will change to "X".
- Use the Left button to confirm the update.
- During the update process the screen will display the names of the various firmware modules being updated; for some modules, you will see a progress bar while the update is completed. The entire update process will take approximately five to seven minutes.
- When the update process is complete, the RMC-1 will switch into Standby mode.

WARNING! DO NOT REMOVE THE USB STICK OR POWER YOUR RMC-1 OFF BEFORE IT SWITCHES INTO STANDBY AT THE END OF THE UPDATE PROCESS. DOING SO MAY RESULT IN SERIOUS FIRMWARE CORRUPTION WHICH MAY REQUIRE FACTORY SERVICE TO CORRECT.

- Remove the USB drive containing the firmware update.

Note: Unless otherwise instructed, you do NOT have to reset your RMC-1 to factory defaults after updating the firmware. The update process itself will NOT erase your current configuration settings.

Creating a Configuration Backup for the RMC-1

The Backup Settings feature on the RMC-1 allows you to save your entire current configuration onto a USB drive. We **STRONGLY** suggest that, after configuring your RMC-1 just the way you want it, you save a backup copy of the configuration. You can then use this backup at a later date to restore your RMC-1 to its current configuration. (This is handy if you want to experiment with various options.)

Note: Most standard USB flash drives can be used to create a configuration backup. The USB drive you use should be formatted using a standard FAT32 format; avoid multiple partitions or drives with permanently installed management software. Either a USB drive formatted on a Windows computer or a pre-formatted USB drive should work, but USB drives formatted on Apple computers using the default settings may not work.

Note: The RMC-1 will only store a single configuration file; this file will be stored in the main folder of the drive, under a pre-configured name. When restoring the configuration, the RMC-1 will automatically use this same file. If desired, you can rename the current configuration file to save multiple versions, but you will have to rename it back to the original name and place it in the default location in order for the RMC-1 to recognize it.

Note: It is perfectly acceptable to use the same USB drive for a firmware update file and a configuration backup.

To back up the configuration on your RMC-1:

- Insert the USB drive into the USB port on the front or back of the RMC-1.
- Press the Menu button.
- Use the Up/Down buttons to select Setup; press the Right button to enter the Setup menu.
- Use the Up/Down buttons to select Advanced; press the Right button to enter the Advanced Setup menu.
- Use the Up/Down buttons to select Backup Settings; press the Right button to enter the confirmation screen.
- Use the Up button to confirm your choice; the confirmation box will change to "X".
- Use the Left button to confirm the backup.
- You will see a status message indicating that the backup is in progress, and another message to confirm when it is completed.
- You may remove the USB drive and exit the Setup Menu as soon as the "Done" status message appears.

Note: The RMC-1 has internal storage which can hold one configuration backup. Initiating the Backup Configuration procedure with no USB flash drive inserted will prompt the RMC-1 to save its configuration to internal memory. Initiating a Restore Settings procedure with no USB drive installed will prompt the RMC-1 to restore the internal configuration backup file - if one exists.

Note: The RMC-1 stores a second copy of the configuration file in the same location as the original for safety purposes; this file is a duplicate of the current backup file; it is NOT a backup of the previous configuration.

Restoring a Configuration Backup to the RMC-1

The Restore Settings feature on the RMC-1 allows you restore a previously saved configuration from a USB drive.

Note: RESTORING A SAVED CONFIGURATION WILL REMOVE/DELETE THE CURRENT CONFIGURATION. If you are unsure about whether you wish to do this, you may wish to save the current configuration - on a different USB flash drive - first.

Note: It is perfectly acceptable to use the same USB drive for a firmware update file and a configuration backup.

Note: In order to restore a configuration to the RMC-1, the file containing it must be stored in the default location on the USB drive, and must have the default file name. If you are managing multiple configuration files, be sure to put the one you want in the correct location, and rename it to the default name, before proceeding.

Note: The RMC-1 has internal storage which can hold one configuration backup. Initiating a Restore Settings procedure with no USB drive installed will prompt the RMC-1 to use the internally stored configuration file - if one exists.

To restore a configuration to your RMC-1:

- Insert the USB drive containing your saved configuration file into the USB port on the front or back of the RMC-1.
- Press the Menu button.
- Use the Up/Down buttons to select Setup; press the Right button to enter the Setup menu.
- Use the Up/Down buttons to select Advanced; press the Right button to enter the Advanced Setup menu.
- Use the Up/Down buttons to select Restore Settings; press the Right button to enter the confirmation screen.
- Use the Up button to confirm your choice; the confirmation box will change to "X".
- Use the Left button to confirm the backup.
- You will see a status message indicating that the restore is in progress, and another message to confirm when it is completed.
- You may remove the USB drive and exit the Setup Menu as soon as the "Done" status message appears.

Note: Unless otherwise instructed, you do NOT have to reset your RMC-1 to factory defaults after restoring a stored configuration.

Note: Restoring a saved configuration will restore all SETTINGS; however certain STATUS information will be lost, which may cause it to appear as if settings were lost. For example, if you restore a configuration that designates one or more Inputs as Last Used, then the Inputs themselves will be configured as Last Used, but the RMC-1 won't remember what mode was used last for that Input and signal type; and so it will have to "relearn" your preferences for each Input configured that way.

Note: Dirac Live for Emotiva Correction Filters are NOT part of the stored configuration.

Performing a Factory Reset on the RMC-1

The Factory Reset feature on the RMC-1 allows you restore all settings to their default factory configuration.

Note: Performing a Factory Reset restores all current settings on your RMC-1 to their factory default settings, but does NOT erase the internal configuration backup file stored on the RMC-1 - if one exists.

Note: While the speaker configuration in the Dirac Speaker Preset will be cleared if you perform a Factory Reset on your RMC-1, the actual Dirac Correction Filters currently stored on your RMC-1 will NOT be deleted.

Note: A Factory Reset is used to restore your RMC-1 to its factory default configuration. It is NOT necessary to perform a Factory Reset after performing a Restore Settings. It is NOT necessary to perform a Factory Reset after performing an Update Firmware - unless otherwise noted in the instructions you receive with the update file or from Emotiva Technical Support.

To perform a Factory Reset on your RMC-1:

- Press the Menu button.
- Use the Up/Down buttons to select Setup; press the Right button to enter the Setup menu.
- Use the Up/Down buttons to select Advanced; press the Right button to enter the Advanced Setup menu.
- Use the Up/Down buttons to select Factory Reset; press the Right button to enter the confirmation screen.
- Use the Up button to confirm your choice; the confirmation box will change to "X".
- Use the Left button to confirm the reset.
- You will see a status message indicating that the Factory Reset is in progress, and another message to confirm when it is completed.
- You may exit the Setup Menu as soon as the "Done" status message appears.

Troubleshooting

Problem: My RMC-1 won't respond to the remote control or the front panel controls.

Reason: Your RMC-1 has no power.

- Confirm that the rear panel Power switch is turned On.
- Confirm that the RMC-1 is plugged into an active outlet.
- Check main fuse in the RMC-1.
- Check internal fuses in the RMC-1.

Problem: My RMC-1 won't respond to the remote control (but the front panel controls work fine).

Reason: Your remote control isn't working.

- Confirm that your remote control has good batteries in it.
- If you're using an IR eye or repeater, confirm that it is configured correctly and located in a position where it isn't blocked or being flooded by another IR light source.

Problem: My RMC-1 takes a long time to start up.

Problem: When I turn on the rear panel Power switch, my RMC-1 turns On, goes through a startup routine, then returns to Standby mode; this takes too long.

Reason: You have the Standby mode on your RMC-1 set to Use Least Power so the RMC-1 has to boot up every time you turn it on.

- Set the Standby mode to Video Remains On.

Problem: When I use the Mode Up/Down buttons on the remote control or the front panel, Reference Stereo Mode isn't there.

Reason: Reference Stereo Mode has to be configured in the Setup Menu.

- In the Setup Menu, configure the Input you're using to use Reference Stereo as its default mode. (For each input, you can set separate default modes for 2 channel and surround sound signals; the default setting for both is "Last Used".)

Problem: The Standby button on my RMC-1 blinks whenever I use any remote control near it, even the one for some other piece of equipment; is something wrong?

Reason: Because the RMC-1 can act as a repeater for signals from any remote control, it listens to all IR remote control signals, and the Standby button blinks whenever the RMC-1 is receiving any remote control signal.

- This is normal.

Troubleshooting

Problem: It seems like I have to set the Volume on my RMC-1 to a much higher/lower number than I did yesterday to get the same output volume.

Reason: The audio processors in the RMC-1 have a feature called normalization; if you adjust the Tone Trims or Level Trims in such a way that the result is to raise the overall gain, the RMC-1 will use its internal master gain control to ensure that digital audio signals aren't clipped. Because this only happens while you're changing the settings, it doesn't affect the dynamics of the music in any way, but it may alter the Volume setting required to produce a specific output level.

- This is normal.

Note: Normalization is a static setting that affects only the overall gain of the RMC-1 (similar to the Master Gain setting on an equalizer), and is necessary to ensure that excessive boost applied by user configuration settings won't cause the RMC-1 to clip loud passages in the music. Normalization is applied at the time you make each user level or trim setting. It does NOT affect the dynamics or dynamic range of the music.

Problem: My RMC-1 seems to be acting oddly; sometimes the Volume control doesn't work, or the RMC-1 turns itself On of Off when I switch the TV or my Blu-Ray player On.

Reason: CEC is a remote control protocol supported to varying degrees by many TVs and Blu-Ray players. CEC is intended to provide a convenient way for some devices to control others; for example, to allow your Blu-Ray player to tell the RMC-1 to switch On when you insert a disc and press Play. Different vendors may refer to CEC by different names and, unfortunately, implementations vary and not everyone follows the same standard. Your RMC-1 ships with its CEC options disabled by default, but CEC commands exchanged between other devices may still cause problems.

- Disable CEC in your other devices. (Most TVs and many Blu-Ray players have some CEC features). You may have to look online, or consult the manufacturers of your other devices, to determine what they call CEC on their devices. Alternately, you can simply disable any "remote control" features on other equipment that you don't use.
- (We are specifically aware of CEC issues when using the RMC-1 with Oppo model BDP-203 and BDP-205 Blu-Ray players, and we strongly suggest disabling CEC support on them.)

Problem: The audio takes a long time to start after I switch inputs on the RMC-1.

Reason: The time it takes for the RMC-1 to lock onto a new incoming signal and start decoding audio is determined by both hardware and firmware. We hope to be able to speed this up a bit in future firmware updates, but it's mostly just part of how the RMC-1 works.

If none of these simple suggestions eliminates your problem, please contact Emotiva Technical Support, at 1-877-366-8324, where a real live person will be happy to get you up and running.

Appendices

RMC-1 Infrared (IR) Remote Control Codes

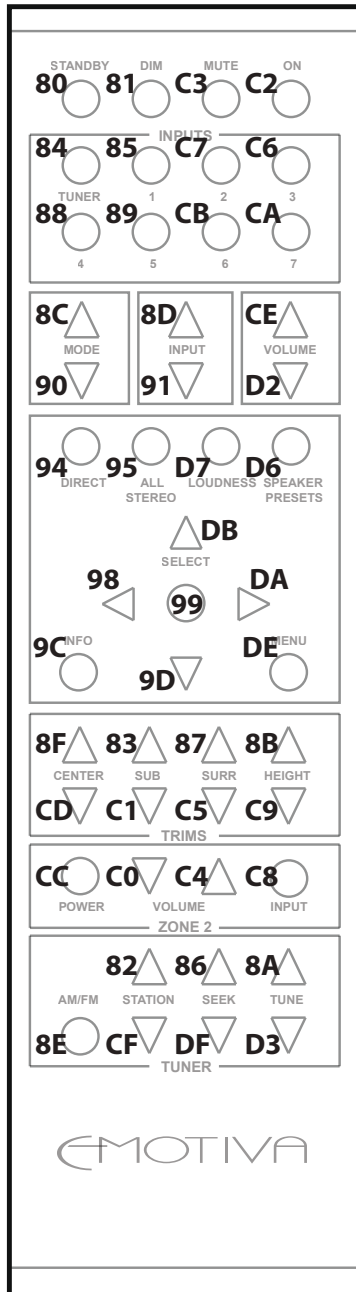

RMC-1
 IR Remote Control Codes
 Product ID (HEX) 0x79

Appendices

RMC-1 Main Outputs (detail and over-the-top views)

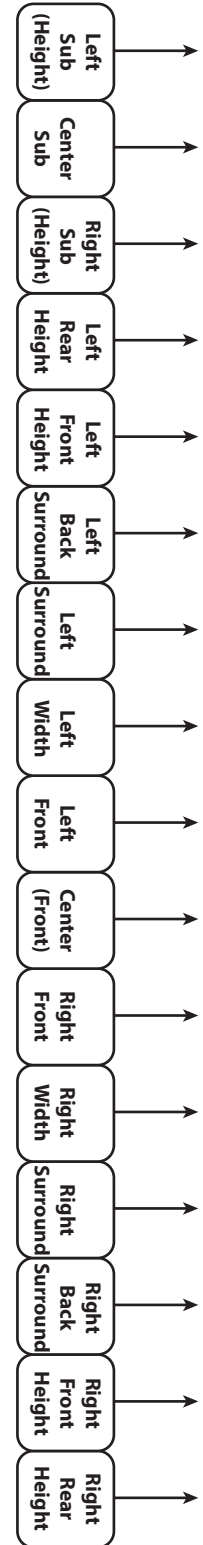

This view will help you identify the outputs on your RMC-1 if you are looking over the top of the unit.

LOOKING OVER THE TOP

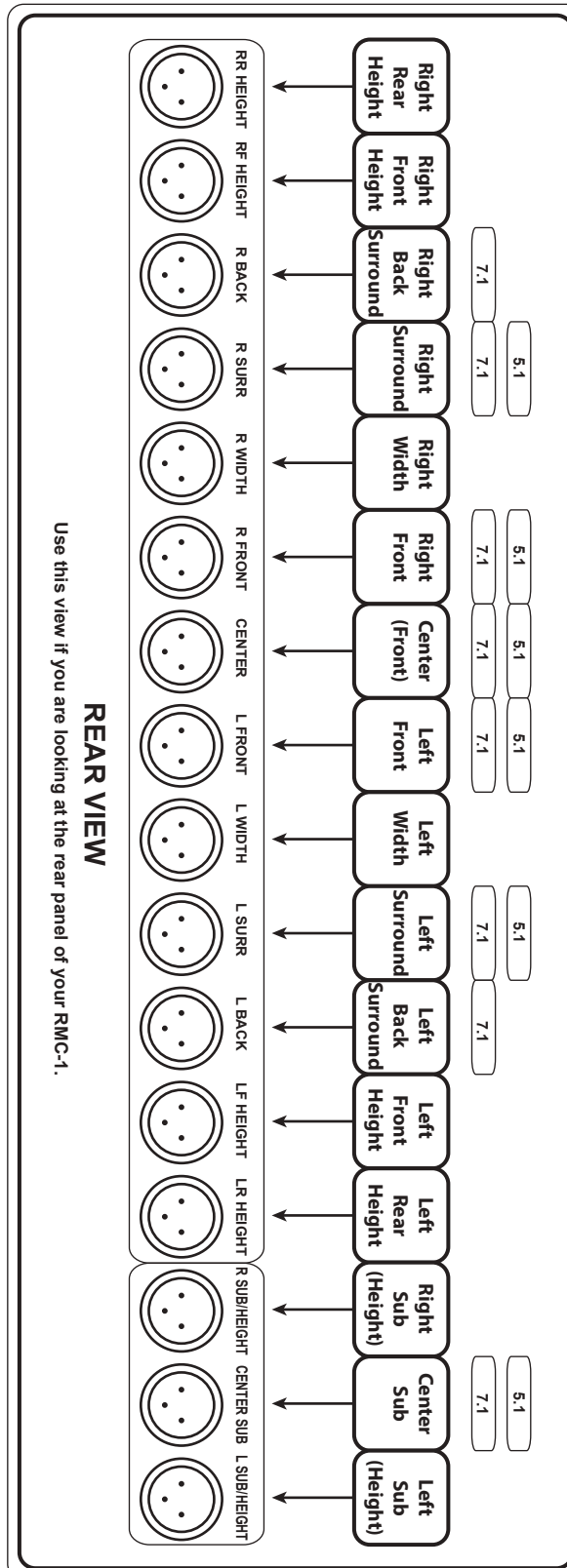

Use this view if you are looking at the rear panel of your RMC-1.

REAR VIEW

Importing and Exporting Parametric EQ Filters

The Parametric EQ filter settings for the two manual speaker presets on the RMC-1 can be exported to and imported from a USB stick in the form of a set of XML files. These XML files may be used as a means of archiving your current filter settings, and as a way of exchanging these settings with third party applications that “understand” them (such as Room EQ Wizard). They will also enable the tech-savvy user to manually edit filter settings, and to copy filter settings from one channel or Speaker Preset to another.

Please read and consider the following information carefully before using this feature:

- This feature is only available for the two manual Speaker Presets (not the Dirac Preset).
- To export a set of filters, use the following command:
Setup | Speakers | (Speaker Preset) | Equalization | Export Filters
- To import a set of filters, use the following command:
Setup | Speakers | (Speaker Preset) | Equalization | Import Filters
- Filter settings may only be exported to and imported from a USB thumb drive.
- The files containing the filter settings are standard XML files, which may be read and edited using any standard XML or text editor, but the file locations and names, and the format of the information they contain, must follow the RMC-1’s default format *exactly*. (The easiest way to see this format is to export a set of filters and examine the files the RMC-1 provides.)
- When the RMC-1 is instructed to Export Filters, it always saves a complete set of filters - based on the current speaker configuration for the Speaker Preset you are currently in. The names of the individual files are based on the channel they represent (the files have a .EMO file extension), the name of the overall folder is based on the name of the current Speaker Preset, **AND THIS INFORMATION IS ALSO CONTAINED INSIDE EACH FILE IN THE FORM OF XML INFORMATION.**
- When the RMC-1 is instructed to Import Filters, it will read all filter files present in the appropriate folder, and replace the settings in the RMC-1 with those contained in the files. Files that are missing will be ignored. (So, if you only have files for your Front Left and Front Right channels in the folder, either because you deleted the others, or because you only instructed REW to save files for those channels, settings for those two channels will be read into the RMC-1, and settings for the other channels will remain unchanged.)
- If you manually enter parameter values into the files, or values are entered by a third-party program, and those values aren’t a precise match for what the RMC-1 expects (perhaps the RMC-1 stores band gain in 0.5 dB steps and you enter a value of +3.279 instead of +3.5), the RMC-1 will do its best to use the nearest value it supports. However, entering values that are out of bounds or “between steps” may produce unexpected results.

Appendices

Here's a simple example that illustrates how this feature works:

We'll use this feature to copy the PEQ settings for the Front Left speaker in Speaker Preset 2 into the Front Right speaker channel in the same Speaker Preset.

- First we'll go into the Setup Menu (on the RMC-1) and we'll Export Filters from Speaker Preset 2.
- This will give us a set of files, one for each speaker channel, in a folder on our USB stick named "filtersPreset2".
- For our example, we will delete all of these files except the one named "leftFront.EMO", which is the file that contains the current settings for our Left Front speaker in this preset.
- We will now rename this file to "rightFront.EMO".
- We will also use our favorite text or XML editor to change the information inside the file to match the new name. (We'll change the XML information near the top of the file from speaker location="leftFront" to speaker location="rightFront").
- Now we'll go into the Setup Menu (on the RMC-1) and we'll Import Filters to Speaker Preset 2.
- When we do this, our new (modified) file containing settings for the Front Right speaker in Preset 2 will be imported, and the settings in the file will replace the current settings on the RMC-1 for that channel in that preset.

Note: Each XML file internally contains information that identifies which channel it goes with, but does NOT contain the name of the associated Speaker Preset internally. This means that you CAN, for example, copy ALL your settings from Preset 1 to Preset 2 by Exporting Filters for Preset 1 and then simply renaming the FOLDER containing the files from filtersPreset1 to filtersPreset2.

Exporting EQ Settings from Room EQ Wizard (to the RMC-1)

REW handles each channel individually, so you must save the information for each channel separately and then combine the files into an appropriately named folder on a USB stick. The latest version of Room EQ Wizard now includes the ability to export correction filters in a format which can then be imported directly into the XMC-1, but has not been updated to do so for the additional channels present in the XMC-2 and the RMC-1. Therefore, you will probably have to manually re-name some of the files it creates in order to import them into the RMC-1. (Again, we recommend you first Export a set of filters from the RMC-1, then use their file naming conventions as a guideline for creating new files to import.)

Appendices

Note on FILE FORMATS AND NAMES: All of the individual XML files containing the settings for each channel **MUST** be placed into a single folder on your USB stick; and the folder must have the appropriate name for the Speaker Preset into which you plan to import it.

Files for import into Speaker Preset 1 must be placed in a folder named “filtersPreset1”.

Files for import into Speaker Preset 2 must be placed in a folder named “filtersPreset2”.

Note: if you find the file naming and folder conventions confusing, it may be easier to Export Filters from the RMC-1 first, which will create the appropriate folders and files on your USB stick, then simply replace the files you wish to update.

Note: The RMC-1 can only Import Filters and Export Filters using a USB thumb drive. You **CANNOT** use the internal storage on the RMC-1 for this purpose.

Note: Each XML file internally contains information that identifies which channel it goes with, but **NOT** the name of the associated Speaker Preset. So, for example, the export file named “rightFront.EMO” is internally identified as being for a Right Front Speaker, but it can be used with either Speaker Preset 1 or Speaker Preset 2, depending on the name of the folder in which you place it on the USB stick.

You **CAN** alter the file to be applied to a different speaker, but to do so you will have to both rename the file **AND** alter the XML item text inside the file which identifies the speaker it was created for.

Note: When the RMC-1 is instructed to Import Filters, it will read all filter files present in the appropriate folder, and replace the settings in the RMC-1 with those contained in the files. Files that are missing will be ignored, and the settings for the channels associated with the missing files will remain unchanged. If you wish to import REW settings for only certain speakers, simply create filter setting files for only those channels; the settings in the files present will be imported and will replace the current settings in the RMC-1 Speaker Preset for those channels, while all other speaker settings in that Speaker Preset will remain unchanged.

Note: If you wish to individually import REW correction settings for specific channels, and clear all other channels, simply do a Reset Filters to clear all settings for that Speaker Preset, then individually update the settings for any individual channels. You can use this method to update channels one at a time.

Warranty

Emotiva Audio Corporation Five-Year Limited Warranty

What does this warranty cover?

Emotiva Audio Corporation (Emotiva) warrants its products against defects in materials and workmanship. This warranty, and all rights provided hereunder, is granted to the original owner, and may be transferred by the current owner to a new owner if the unit is gifted or sold. In the event the original owner transfers ownership of the Product prior to the expiration of the applicable term described below, this Warranty shall terminate at the end of the original term.

This Warranty only applies to Products purchased directly from Emotiva or any of its Authorized Dealers or International Distributors.

Emotiva warrants any replacement product or part furnished hereunder against defects in materials and workmanship for the longer of the following: (i) the amount of time remaining under the original warranty, or (ii) 120 days from your receipt of the repaired or replaced product. The duration described in this paragraph is hereinafter referred to as the "Term".

TO THE FULLEST EXTENT PERMITTED BY LAW, ALL IMPLIED WARRANTIES RELATED TO THE ORIGINAL PRODUCT AND ANY REPLACEMENT PRODUCT OR PARTS (INCLUDING IMPLIED WARRANTIES OF MERCHANTABILITY AND FITNESS FOR A PARTICULAR PURPOSE) ARE EXPRESSLY LIMITED TO THE TERM OF THIS LIMITED WARRANTY. SOME STATES DO NOT ALLOW LIMITATIONS ON HOW LONG AN IMPLIED WARRANTY LASTS, SO THE ABOVE LIMITATION MAY NOT APPLY TO YOU.

The original owner must make a claim within the Term of the Warranty. A claim shall not be valid (and Emotiva has no obligation related to the claim) if it is not made within the Term and if it is not made in strict compliance with the requirements of the "How do you get service?" section.

How long does this coverage last?

The warranty on the Emotiva RMC-1 commences on the date of retail purchase by the original retail purchaser and runs for a period of five years thereafter. This warranty may be transferred by the current owner to a new owner at any time during the original term. Emotiva warrants any replacement product or part furnished hereunder against defects in materials and workmanship for the longer of the following: (i) the amount of time remaining under the original warranty, or (ii) 120 days from your receipt of the repaired or replaced product. The duration described in this paragraph is hereinafter referred to as the "Term".

What will Emotiva do?

Emotiva will, at its option, either: (i) repair the product, or (ii) replace the product with a new consumer product which is identical or reasonably equivalent (in Warrantor's sole discretion) to the product. In the event Warrantor, in its sole discretion, is unable to replace or repair the Product or it is not commercially practicable to do so, then: (i) if the claim was submitted during the first 365 days of the Term, Warrantor shall refund to you the purchase price that you paid for the Product; and (ii) if the claim was submitted after the first 365 days of the Term, Emotiva shall issue you a credit equal to the purchase price that you paid for the product. The credit may only be used for the purchase of merchandise from Emotiva, and cannot be used for freight charges.

Warranty

When a Product or part is repaired or replaced, any replacement item becomes your property and the replaced item becomes Emotiva's property. When a refund or credit is given, the Product for which the refund or credit is provided must be returned to Emotiva and becomes Emotiva's property.

What is not covered by this warranty?

This warranty does not apply: (i) to damage caused by use with products not manufactured by Emotiva, where the non-Emotiva product is the cause of the damage; (ii) to damage caused by service or maintenance performed by anyone who is not a representative of Emotiva; (iii) to damage caused by accident, abuse, misuse, flood, fire, earthquake or other external causes; (iv) to a product or part that has been modified after its retail purchase, where the modification caused or contributed to the damage; (v) to consumable parts, such as batteries or failure of or damage to the Product caused by batteries; (vi) if any Emotiva serial number has been removed or defaced on the product; (vii) glass or plastic panels, cabinetry, trim or other appearance items; (viii) cosmetic wear or damage to remote controls by user.

EMOTIVA SHALL NOT BE LIABLE FOR ANY INCIDENTAL OR CONSEQUENTIAL DAMAGES ARISING FROM OR RELATED TO ANY DEFECTS IN OR DAMAGES TO ITS PRODUCTS. SOME STATES DO NOT ALLOW THE EXCLUSION OR LIMITATION OF INCIDENTAL OR CONSEQUENTIAL DAMAGES, SO THE ABOVE LIMITATION OR EXCLUSION MAY NOT APPLY TO YOU.

How do you get service?

In order to make a claim under the Warranty, you must:

1. Call or e-mail a customer service representative at 1-877-EMO-TECH (1-877-366-8324) or support@emotiva.com. You must provide a description of your problem, the serial number of the Product for which the warranty claim is being made, and the original purchase date.
2. Then, you will be provided with a warranty service authorization number ("WS").
3. Next, you must ship the Product to the following address, with the WS written in large, bold numbers on the outside of the box, and with the letters "WS" written before the number, for example: WS1234. Parcels arriving without a WS number on the outside of the box will be refused. The customer pays for the shipping to Warrantor. Warrantor pays for the shipping back to the customer within the continental United States only. Customer is responsible for shipping charges on all other warranty claims.

**Emotiva Audio Corporation
Attn: Repair Department
139 Southeast Parkway Court
Franklin, TN 37064**

Units will be refused by Emotiva for the following:

- Product was sent without the WS#
- Product was sent with inadequate packaging.
- Product was damaged in transit.
- Product was shipped collect for shipping charges.

Warranty

How does state law apply?

This warranty gives you specific legal rights, and you may also have other rights which vary from state to state.

What if my product is damaged on the way to you?

Emotiva is not liable for damages that may incur while an item is in transport to us. Please purchase insurance when you ship your item. If your Product was not adequately packaged, we will refuse receipt and the damaged package will be returned to you at your cost. If you do not have the original Emotiva Audio packaging, please check with our sales department to purchase replacement-shipping cartons.

How does the Warranty and service apply to international orders?

The Product Warranty is only valid in the country where the Emotiva product was originally shipped via an authorized dealer, distributor, or direct from the Emotiva factory. The Warranty is subject to change at any time depending on the laws and regulations within your specific country. Please check with your distributor for a complete understanding of the warranty in your county.

If you purchased your Emotiva Product outside of the USA and wish to have it serviced at the factory, all freight charges are your responsibility. If you do not have an authorized distributor or repair center in your country, your Product must come back to the Emotiva USA factory for warranty service.



Manufactured under license from Dolby Laboratories. Dolby, Dolby Atmos, Dolby Vision, and the double-D symbol are trademarks of Dolby Laboratories. Copyright © 2018 Dolby Laboratories. All rights reserved.

Manufactured under license from DTS, Inc. DTS, the Symbol, DTS and the Symbol together, DTS:X, and the DTS:X logo, Neural:X, and the Neural:X logo, are registered trademarks and/or trademarks of DTS, Inc in the United States and/or other countries. ©DTS, Inc. All Rights Reserved.



The terms HDMI and HDMI High-Definition Multimedia Interface, and the HDMI Logo are trademarks or registered trademarks of HDMI Licensing LLC in the United States and other countries..

This item incorporates copy protection technology that is protected by U.S. patents and other intellectual property rights of Rovi Corporation. Reverse engineering and disassembly are prohibited





Emotiva Audio Corporation
135 Southeast Parkway Court
Franklin, TN 37064
www.emotiva.com