

PURE

Evoke H6



Evoke H6

EN

DE

FR

IT

NO

DA

NL

Thank you for choosing the Evoke H6. This user manual explains how to use the various features of your Evoke H6. If you need more help, you can view our help topics at support.pure.com.

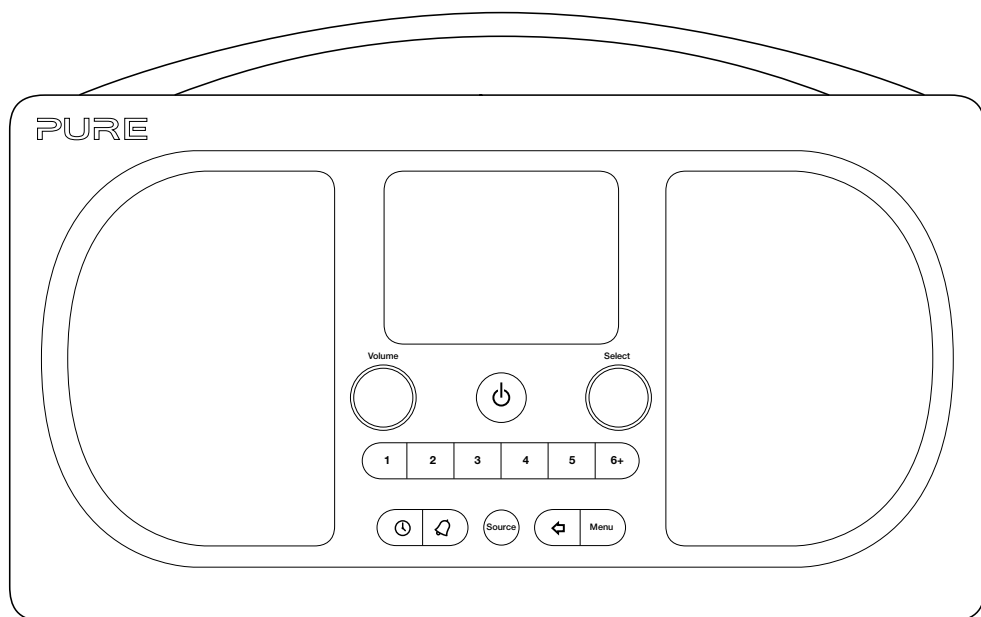

Evoke H6	1	Alarms	12
Safety	4	Setting an alarm	12
Getting started	5	Cancelling an existing alarm	12
Your Evoke	5	Snoozing or silencing an alarm	12
Setting up your Evoke H6	6	Timers	13
Switching your Evoke H6 on and off	7	Setting the kitchen timer	13
Changing the volume	7	Silencing the kitchen timer	13
Digital radio	8	Setting the sleep timer	13
Listening to digital radio	8	Settings	14
Changing the digital radio station	8	Personalising the sound on your Evoke H6	14
Automatically tuning to digital radio stations	8	Display settings	14
FM radio	9	Clock settings	15
Listening to FM radio	9	Changing the language	16
Changing the FM radio station	9	Resetting to factory settings	16
Changing the scan settings for FM radio	9	Updating the software	16
Choosing stereo or mono reception for FM radio	9	Using a ChargePAK	17
Radio station presets	10	About ChargePAKs	17
About presets	10	Inserting a ChargePAK	17
Storing a radio station as a preset	10	Troubleshooting	18
Listening to a preset	10	Specifications	19
Bluetooth and auxiliary devices	11		
Connecting a Bluetooth device	11		
Connecting a device with an auxiliary cable	11		

Safety



Safety instructions and cautions

1. Read, heed and retain these instructions – All the safety and operating instructions should be read before this product is used and retained for future reference. All warnings on the appliance and in the operating instructions should be followed
2. Failure to install or use the product in accordance with these instructions may impair the safety of the product and invalidate the warranty.
3. Use only power supply listed in these user manual/user instructions (supplied by Pure with model number SW1202400-IM) to power the equipment and do not use the power supply for any other purpose.
4. The direct plug-in adapter is used as a disconnect device, the disconnect device shall remain readily operable and accessible.
5. Do not immerse in water or use in a wet / moist environment, such as in the shower or bathroom if plugged into the mains supply. The power supply shall not be exposed to dripping or splashing and no objects filled with liquids, such as vases, placed above it.
6. Do not remove screws from or open the product casing.
7. Keep the product away direct sunlight and from heat sources such as radiators, heaters or other appliances that produce heat.
8. Danger of explosion if the battery is incorrectly replaced (ensure correct polarity). Replace only with the same type. The battery shall not be exposed to excessive heat such as sunshine, fire or similar. Attention is drawn to the environmental aspects of battery disposal. **See Section - "Using a ChargePAK"**
9. Do not expose the product to naked flame sources, such lighted candles which should not be placed on or near the product.
10. Ventilation should not be impaired by covering the product or power supply.
11. Clean only with a dry cloth.
12. This product is intended for use in moderate climates.
13. If the product is used in a manner not specified by the instructions, the product's protection could be impaired.
14. Do not use the product if any damage is noticed.
15. Product repairs are only allowed to be carried out by competent and authorised personnel.

ChargePAK F1 safety instructions

1. Read the instructions for ChargePAK use in this document.
2. Only use your ChargePAK with original Pure products. Use only the original Pure ChargePAK F1. Caution: Danger of explosion if battery is incorrectly replaced or another type used.
3. Store ChargePAK in a cool, dry place at normal room temperature. Remove from devices that will be stored unused for extended periods.
4. Do not puncture, modify, drop, throw, or cause other unnecessary shocks to your ChargePAK. May present a risk of fire, explosion, or chemical burn if mistreated.
5. Do not dispose of ChargePAK in a fire or incinerator, or leave in hot places such as a motor car under direct sunlight. Do not store near oven, stove, or other heat source.
6. Do not connect ChargePAK directly to an electrical source, such as a building outlet or automobile power-point. Do not place into a microwave oven, or any other high-pressure container.
7. Do not immerse ChargePAK in water or otherwise expose it to liquids.
8. Do not short circuit ChargePAK.
9. Do not use or charge a ChargePAK that appears to be leaking, discoloured, rusty, deformed; emitting an odour; or is otherwise abnormal.
10. Do not touch a leaking ChargePAK directly; wear protective material to remove and dispose of it properly immediately.
11. Do not store where children may have access.
12. Dispose of ChargePAK as per normal rechargeable batteries according to the local laws and regulations of your region.

Symbols used on this product

Symbol	Description
	This symbol is used on the product to indicate a caution and that instructions should be read before use.
	This symbol indicates DC voltage.
	This symbol indicates where the product is switched on or put into standby.

Getting started

Your Evoke

Front controls

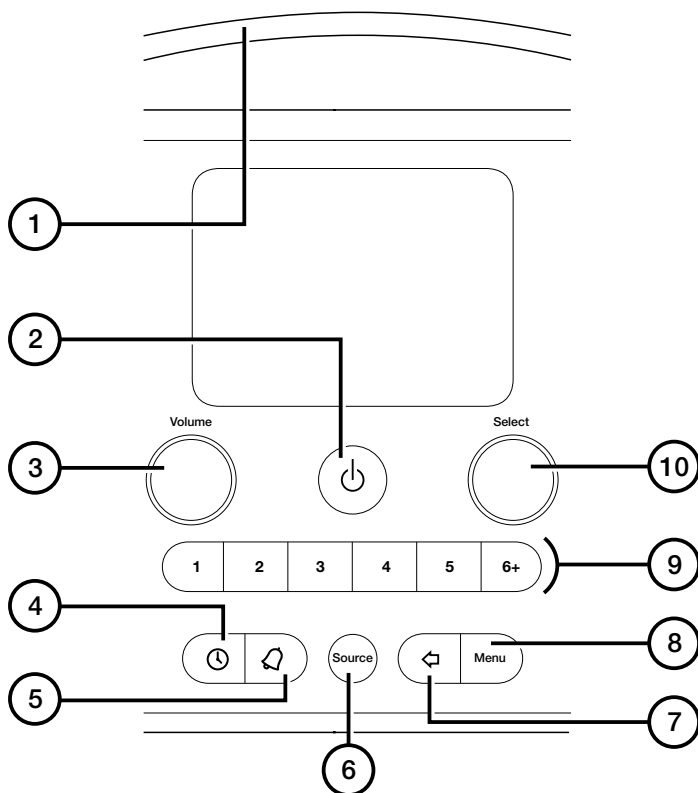

- | | | |
|----|---------------------|---|
| 1 | Snoozehandle | Tap to snooze an alarm or brighten the screen when dimmed |
| 2 | Standby | Switch your Evoke H6 on and off, or put it in standby |
| 3 | Volume | Turn to change the volume, press to mute the volume |
| 4 | Timer | Press to set a sleep timer |
| 5 | Alarm | Press to set an alarm or a kitchen timer |
| 6 | Source | Press to change between digital radio, FM radio, Bluetooth, and auxiliary input |
| 7 | Back | Press when in the menu to go back to the previous screen |
| 8 | Menu | Press to change settings and options |
| 9 | Presets | Press to store and access your favourite radio stations |
| 10 | Select | Turn and press to browse radio stations, or select settings and options |

Rear connections



12V DC 2.4A

Input for supplied mains adapter only



3.5mm output for stereo headphones



Aux in

Analogue stereo input for auxiliary cables

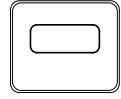

Micro USB connector for software updates

Setting up your Evoke H6

To set up your Evoke H6:

1. Unclip the aerial and fully extend it.
2. Connect the supplied mains adapter to the input on the back of your Evoke H6.
3. Plug the mains adapter into the mains supply.

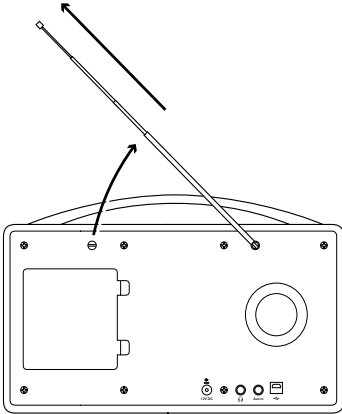

v

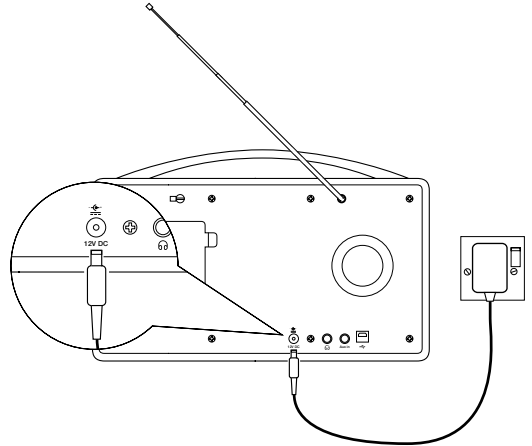

Switching your Evoke H6 on and off

If you have a ChargePAK rechargeable battery, insert it before you switch your Evoke H6 on. Read more about using a ChargePAK on page 17.

To switch your Evoke H6 on:

- Press .

Note: When you switch your Evoke H6 on for the first time, it starts tuning to digital radio stations. After the autotune is complete, you can start listening to digital radio.

To switch your Evoke H6 off or put it in standby:

- Press .

If your Evoke H6 is being powered by a ChargePAK, your Evoke H6 switches off. If your Evoke H6 is connected to a power socket, your Evoke H6 enters standby. In standby, your Evoke H6 uses a low amount of power and displays the time and date on the screen.

Changing the volume

To change the volume:

- To increase the volume, turn the **Volume** dial clockwise.
- To decrease the volume, turn the **Volume** dial anticlockwise.

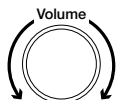

To mute the volume:

- Press the **Volume** dial.

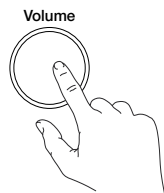

Digital radio

Listening to digital radio

To listen to digital radio:

- Press  until 'Digital Radio' is displayed.

Tip: Some digital radio stations also broadcast information and graphics, such as music album artwork or weather updates. Press the **Select** dial to change between slideshow, large slideshow and display modes.

Changing the digital radio station

To change the digital radio station:

1. Turn the **Select** dial left or right to browse through the available radio stations.
2. Press the **Select** dial to change radio station.

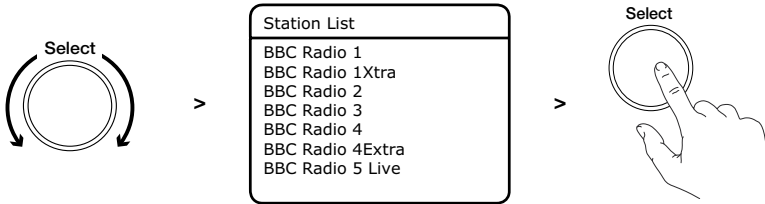

Tip: A '>>' next to a radio station name means the station has a secondary service, which provides more content. The secondary service is listed below the radio station with a '<<' next to the service name.

Secondary services may only be available at certain times.

A '?' next to a radio station name means the station is inactive or unavailable.

Automatically tuning to digital radio stations

When you switch your Evoke H6 on for the first time, it automatically scans for digital radio stations. If you move your Evoke H6 to a new location, perform an autotune to update the list of radio stations.

To automatically tune to digital radio stations:

1. Press .
2. Turn and press the **Select** dial to choose 'Autotune'.
Your Evoke H6 starts scanning for digital radio stations.

FM radio

Listening to FM radio

To listen to FM radio:

- Press  until 'FM' is displayed.

Changing the FM radio station

To change the FM radio station:

- To scan to the previous or next radio station, turn the **Select** dial left or right and then press the **Select** dial.

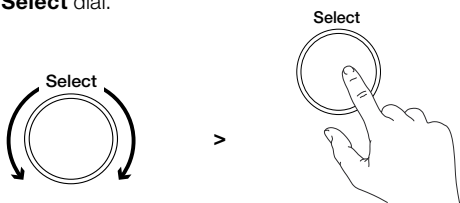

- To manually tune to a radio station, turn the **Select** dial left or right. The frequency steps up or down by 0.05 MHz.

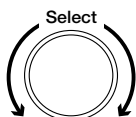

Changing the scan settings for FM radio

When you scan for FM radio stations, you can include all radio stations or only those with a strong signal.

To change scan settings for FM radio:

1. Press .
2. Turn and press the **Select** dial to choose 'Scan Setting'.
3. Turn and press the **Select** dial to choose 'Strong Stations Only' or 'All Stations'.

Choosing stereo or mono reception for FM radio

By default, your Evoke H6 uses stereo reception for FM radio. If your FM radio stations have a weak signal, try using mono reception to improve the signal strength.

To choose stereo or mono reception:

1. Press .
2. Turn and press the **Select** dial to choose 'Stereo'.
3. Turn and press the **Select** dial to choose 'FM Stereo' or 'Forced Mono'.

Radio station presets

About presets

You can store your favourite radio stations as presets. You can use presets to quickly tune to your stored radio stations whenever you want.

On the front of your Evoke H6, there are six preset buttons. Use **1** to **5** for quick access to your favourite radio stations. Use **6+** to open a list of all your presets.

You can store up to 20 digital radio stations and up to 20 FM radio stations as presets.

Storing a radio station as a preset

To store a radio station to a preset from 1 to 5:

1. Tune to the radio station you want to store.
2. Choose a preset button from **1** to **5** then press and hold it until a  is displayed.

Tip: If there is already a radio station stored to the preset you've selected, the new station replaces it.

To store a radio station to the preset list:

1. Tune to the radio station you want to store.
2. Press and hold **6+** until the preset list is displayed.
3. Turn and press the **Select** dial to choose a preset number. A  is displayed.

Tip: If there is already a radio station stored to the preset you've selected, the new station replaces it.

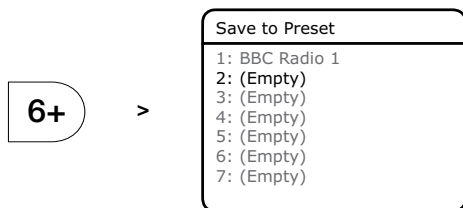

Listening to a preset

To listen to a preset from 1 to 5:

- Press a preset button from **1** to **5**. For example, to listen to the radio station stored as preset 2, press **2**.

To listen to any preset:

1. Press **6+** to open the preset list.
2. Turn and press the **Select** dial to choose a preset.

Bluetooth and auxiliary devices

Connecting a Bluetooth device

You can use Bluetooth to wirelessly connect to a device, such as a mobile phone or tablet. You can then stream music from your mobile phone or tablet through your Evoke H6.

The first time you connect a Bluetooth device to your Evoke H6, you need to pair them. After you've paired a device with your Evoke H6, your Evoke H6 remembers it for the next time.

To connect a Bluetooth device:

1. Press  until 'Bluetooth' is displayed.

2. On your Bluetooth device, switch Bluetooth on and connect to your Evoke H6.

Note: For more information, see your Bluetooth device's user manual. If you are asked to enter a passcode, enter 0000.

When 'Connected' is displayed on your Evoke H6 screen, your Evoke H6 is ready to stream music.

Tip: If you want to connect a different Bluetooth device to your Evoke H6, switch off Bluetooth on the connected device first.

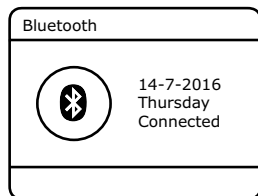

Connecting a device with an auxiliary cable

You can use an auxiliary cable to connect a device, such as an MP3 player, to your Evoke H6. You can then enjoy music saved on the device through your Evoke H6.

To connect a device with an auxiliary cable:

1. Press  until 'Auxiliary Input' is displayed.

2. Insert an auxiliary cable into the **Aux in** socket on the back of your Evoke H6.

3. Insert the other end of the auxiliary cable into the device you want to connect. Your Evoke H6 is now ready to play music from the connected device.

Alarms

To wake up to your favourite radio station, you can set up to two alarms on your Evoke H6.



Note: Alarms will not work when your Evoke H6 is being powered by a ChargePAK and off.

Setting an alarm

To set an alarm:

1. Press .
2. Turn and press the **Select** dial to choose 'Alarm 1' or 'Alarm 2'.
3. Turn and press the **Select** dial to change settings for the alarm.

'Alarm'	Turn the alarm on or off
'Frequency'	Choose how often you want the alarm to sound
'Wake Up time'	Choose the time for the alarm
'Source'	Choose to wake up to an FM or digital radio station, or a buzzer Tip: To choose FM or digital radio, you need to have stored a radio station as a preset.
'Preset'	Choose a radio station to wake up to
'Duration'	Choose how many minutes the alarm sounds for
'Volume'	Choose the volume for the alarm

4. When you have made all of your changes, press  to exit the menu.
The  or  symbol is displayed at the bottom of the screen when an alarm is set.

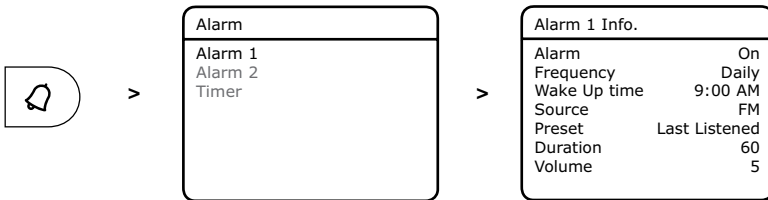

Cancelling an existing alarm

To cancel an existing alarm:

1. Press .
2. Turn and press the **Select** dial to choose 'Alarm 1' or 'Alarm 2'.
3. Turn and press the **Select** dial to change the 'Alarm' setting to 'Off'.

Snoozing or silencing an alarm

To snooze an alarm:

- Touch the **SnoozeHandle**.
The alarm snoozes for 5 minutes.

To silence an alarm:

- Press .

Timers

Setting the kitchen timer

The kitchen timer counts down and then ends with an alarm tone.

To set the kitchen timer:

1. Press .
2. Turn and press the **Select** dial to choose 'Timer'.
3. Turn the **Select** dial to choose the duration of the timer.
4. Press the **Select** dial to start the timer.

The  symbol is displayed at the bottom of the screen when the timer is set.

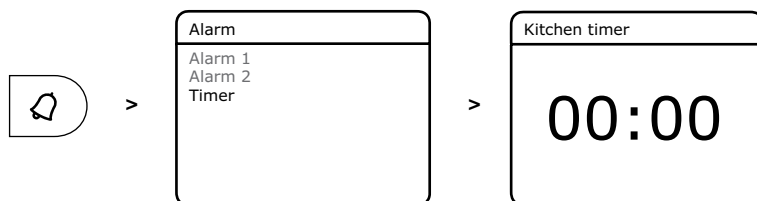

Silencing the kitchen timer

To silence the kitchen timer:

- Press .

Setting the sleep timer

The sleep timer puts your Evoke H6 in standby after a set amount of time.

To set the sleep timer:

1. Press .
2. Turn the **Select** dial to choose the duration of the timer.
Tip: You can choose between 15 and 90 minutes.
3. Press the **Select** dial to start the timer.

The  symbol and remaining time is displayed at the bottom of the screen when the timer is set.

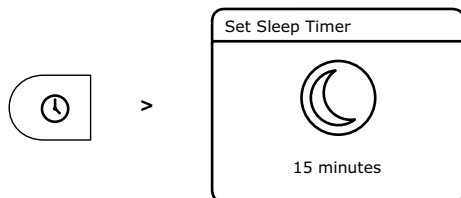

Settings

Personalising the sound on your Evoke H6

Use the equaliser and boost setting to get the most out of your music. There are several equaliser settings set up already. For example, to hear classical music at its best, change the equaliser setting to 'Classic'. You can also customise the equaliser to change the treble, bass and loudness.

To use the equaliser:

1. Press .
2. Turn and press the **Select** dial to choose 'Audio'.
3. Turn and press the **Select** dial to choose 'Equaliser'.
4. Choose an equaliser setting:
 - To choose an equaliser setting, turn and press the **Select** dial.
 - To use custom settings, turn and press the **Select** dial to choose 'Custom'. Then turn and press the **Select** dial to change the treble, bass and loudness.

Display settings

Changing the information displayed on the screen

You can change the information that is displayed on the screen when you are listening to the radio. For example, you can display scrolling information about the current radio station.

To change the information displayed on the screen:

1. Press .
2. Turn and press the **Select** dial to choose 'Display'.
3. Turn and press the **Select** dial to choose 'Info'.
4. Turn and press the **Select** dial to choose the information to display.

Changing the screen brightness

Your Evoke H6 has a light sensor, which adjusts the screen brightness based on your surroundings. You can also manually change the screen brightness.

To help save energy, you can dim the screen after 10 seconds of inactivity.

To change the brightness of the screen when switched on:

1. Press .
2. Turn and press the **Select** dial to choose 'Display'.
3. Turn and press the **Select** dial to choose 'On Level'.
4. Turn and press the **Select** dial to choose a brightness level. To make your screen brighter, choose a higher number. To automatically set the screen brightness, choose 'Auto'.

To dim the screen after 10 seconds of inactivity:

1. Press .
2. Turn and press the **Select** dial to choose 'Display'.
3. Turn and press the **Select** dial to choose 'Duration'.
4. Turn and press the **Select** dial to choose 'Timed'.

To change the brightness of the screen when dimmed:

1. Press .
2. Turn and press the **Select** dial to choose 'Display'.
3. Turn and press the **Select** dial to choose 'Dim Level'.
4. Turn and press the **Select** dial to choose a brightness level. To make your screen brighter, choose a higher number.

Clock settings

Setting the time and date

Your Evoke H6 can use FM and digital radio signals to set the time and date automatically. If the time and date do not update automatically, you can set them manually.

To set the time and date automatically:

1. Press .
2. Turn and press the **Select** dial to choose 'Clock'.
3. Turn and press the **Select** dial to choose 'Auto Update'.
4. Turn and press the **Select** dial to choose how to set the time and date.

To set the time and date manually:

1. Press .
2. Turn and press the **Select** dial to choose 'Clock'.
3. Turn and press the **Select** dial to choose 'Set Time/Date'.
4. Turn and press the **Select** dial to set the date.
5. Turn and press the **Select** dial to set the time.

Changing the time format

To change the time format:

1. Press .
2. Turn and press the **Select** dial to choose 'Clock'.
3. Turn and press the **Select** dial to choose 'Set 12/24 Hour'.
4. Turn and press the **Select** dial to choose the time format.

Changing the date format

To change the date format:

1. Press .
2. Turn and press the **Select** dial to choose 'Clock'.
3. Turn and press the **Select** dial to choose 'Set Date Format'.
4. Turn and press the **Select** dial to choose the date format.

Changing the language

You can change the language of menus and settings.

To change the language:

1. Press .
2. Turn and press the **Select** dial to choose 'Settings'.
3. Turn and press the **Select** dial to choose 'Language'.
4. Turn and press the **Select** dial to choose a language.

Resetting to factory settings

A factory reset removes all stored presets, alarms, timers and settings on your Evoke H6.

Note: You cannot undo a factory reset.

To reset to factory settings:

1. Press .
2. Turn and press the **Select** dial to choose 'Settings'.
3. Turn and press the **Select** dial to choose 'Factory Reset'.
4. Turn and press the **Select** dial to choose 'Yes'.
Your Evoke H6 resets to factory settings and then restarts.

Updating the software

Pure may provide software updates to your Evoke H6. To check for available software updates, visit support.pure.com.

Tip: To be contacted when software updates are available, you can register your product at pure.com/register.

To check the current software version:

1. Press .
2. Turn and press the **Select** dial to choose 'Settings'.
3. Turn and press the **Select** dial to choose 'Software Version'.

To update the software:

1. Use a Micro USB cable to connect your Evoke H6 to your computer.
2. Follow the instructions provided with the software update file.

Using a ChargePAK

About ChargePAKs

A ChargePAK is a rechargeable battery pack that allows you to listen to your music anywhere. When your Evoke H6 is connected to a power outlet, it charges the ChargePAK. You can then disconnect your Evoke H6 from the power and take your music with you.

Inserting a ChargePAK

⚠ Note: Your Evoke H6 is only compatible with a Pure ChargePAK F1. Do not use any other batteries or ChargePAK models with your Evoke H6.

To insert a ChargePAK:

1. Switch your Evoke H6 off and disconnect it from the power supply.
2. At the back of your Evoke H6, press the two clips on the battery cover to remove it.
3. Insert the ChargePAK into the battery compartment, with the electrical contacts on the ChargePAK facing down and the Pure label facing you.
4. Replace the battery cover.
5. Connect your Evoke H6 to the power supply. The ChargePAK starts charging. If the ChargePAK is new or has not been used for a long time, we recommend you charge it for at least 24 hours.

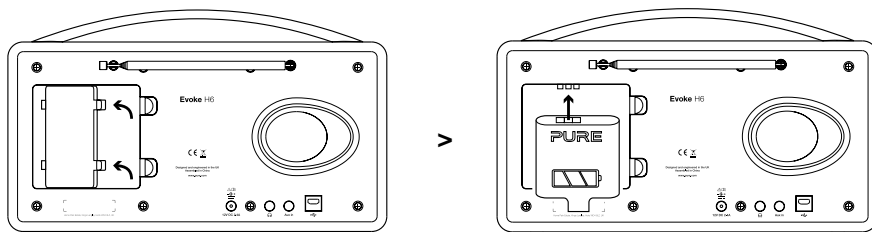

Note: When the ChargePAK is charging, it is normal for it to get warm. The efficiency of the ChargePAK may decrease over time.



Troubleshooting

Problem	Solution
I can't hear any sound	<p>Use the Volume dial to turn the volume up.</p> <p>For digital radio, perform an autotune. Read more on page 8.</p> <p>For Bluetooth or auxiliary devices, check a device is connected. Turn the volume up on the connected device.</p>
The screen is very dark	<p>Remove any obstructions from in front of the speaker. There is a light sensor behind the speaker grill.</p> <p>Turn up the screen brightness. Read more on page 14.</p>
I can't find an FM or digital radio station	<p>Adjust your aerial and check it is fully extended.</p> <p>Move your radio to another location.</p> <p>For digital radio, perform an autotune. Read more on page 8.</p> <p>For FM radio, try using mono reception to improve the signal strength. Read more on page 9.</p>

Specifications

Radio	Digital and FM radio	
Frequencies	DAB/DAB+ FM radio 87.5-108MHz	
Bluetooth	Bluetooth v4.1 Frequency range: 2402 < 2480 MHz, Maximum power: <10.0 dBm (EIRP) A2DP support	
Speaker	2 x Full range 3" driver unit	
Audio output power	20 Watts RMS	
Inputs	12V DC power adapter socket (230V supplied) 3.5mm stereo Aux In for auxiliary devices USB connection (Micro USB) for software updates only	
Outputs	3.5mm stereo headphone	
Presets	20 digital radio and 20 FM radio presets	
Display	2.8" colour display	
Software version	v1RC5	
Mains power adapter	Adapter	Input AC 100-240V~, 50/60 Hz, 0.8A Output DC 12V  , 2400mA
	Main unit	DC 12V  , 2.4A
ChargePAK	Pure ChargePAK F1 rechargeable battery pack (available separately)	
Power consumption	Standby: 0.8W Active: 4.5W	
Dimensions	180mm high x 305mm wide x 128mm deep	
Aerial	Captive telescopic aerial	
Approvals		CE marked. Compliant with RED 2014/53/EU and RoHS Directives (1999/95/EC and 2011/65/EU). ETSI EN300 401 compliant. The full text of the EU Declaration of Conformity is available at the following internet address http://www.pure.com/about/red

Warranty information

Pure international Limited warrants to the end user that this product will be free from defects in materials and workmanship in the course of normal use for a period of two years from the date of purchase. This guarantee covers breakdowns due to manufacturing or design faults; it does not apply in cases such as accidental damage, however caused, wear and tear, negligence, adjustment, modification or repair not authorised by us. Should you have a problem with your unit please contact your supplier or contact Pure Support at <http://support.pure.com>

Disclaimer

Pure international Limited makes no representation or warranties with respect to the content of this document and specifically disclaims any implied warranties of merchantability or fitness for any particular purpose. Further, Pure international Limited reserves the right to revise this publication and to make changes in it from time to time without obligation of Pure international Limited to notify any person or organization of such revisions or changes.

Trademarks

Evoke, Evoke H6, Pure and the Pure logo are trademarks or registered trademarks of Pure international Limited.

Copyright

Copyright © 2018 Pure international Limited. All rights reserved. No part of this publication may be copied or distributed, transmitted, transcribed, stored in a retrieval system, or translated into any human or computer language, in any form or by any means, electronic, mechanical, magnetic, manual or otherwise, or disclosed to third parties without the express written permission of Pure international Limited.

Correct disposal of this product



This marking indicates that this product should not be disposed with other household waste throughout the EU. To prevent possible harm to the environment or human health from uncontrolled waste disposal, recycle it responsibly to promote the sustainable reuse of material resources. To return your used device, please use the return and collection system or contact the retailer where the product was purchased. They can take this product for environmental safe recycling.