



LIVE STREAMING MICROPHONE

AG 01

User Guide

EN

Contents

Introduction	5
<hr/>	
About this Guide	5
How the manuals are organized	7
Product features	8
Accessories	9
Component names and functions	10
<hr/>	
Front side	10
Rear panel	11
Bottom	13
Getting ready to use this product	15
<hr/>	
Connecting to an iPhone/iPad	15
Connecting to Android devices	17
Connecting to your computer and configuring the settings (Windows)	19
Connecting to your computer and configuring the settings (Mac)	21
Using this product for livestreaming (17LIVE, Twitch, YouTube Live)	23
<hr/>	
Using with an iPhone/iPad	23
Using this product with an Android device	26
Using this product with your computer	29
Operations while livestreaming	33
Connecting your musical instrument or music player	35
Using this product for game chats (Discord)	36
<hr/>	
Using with an iPhone/iPad	36
Using this product with an Android device	40
Using this product with your computer	43

Using this product in a Web meeting	46
Using with an iPhone/iPad	46
Using this product with an Android device	50
Using this product with your computer	53
Using this product for a podcast	56
Using WaveLab Cast	56
Using this product for recording	57
Using Rec'n'Share with an iPhone/iPad	57
Using Cubase AI with your computer	58
Using this product in music production	59
Using Cubasis LE with an iPhone/iPad	59
Using Cubase AI with your computer	60
Attaching this product onto a mic stand or desk-mounted microphone boom arm	61
How to attach	61
Reattaching the stand for this product	64
Troubleshooting	65
Power-related	65
Audio-related and other issues	66
Appendix	67
General specifications	67
Microphone specifications	68
Input / Output characteristics	69
Dimensions	70
Polar pattern	71

Frequency response	72
Block and level diagrams	73

Introduction

About this Guide

Notice regarding the contents of this guide

This user guide explains about connecting and operating this product for the user. The precautions and other matters are classified as follows.

-  **WARNING**

This content indicates “risk of serious injury or death.”

-  **CAUTION**

This content indicates “risk of injury.”

- **NOTICE**

Indicates points that you must observe in order to prevent product failure, damage or malfunction and data loss, as well as to protect the environment.

- **NOTE**

Indicates notes on instructions, restrictions on functions, and additional information that may be helpful.

- All illustrations and screens shown in this guide are for explanatory purposes.
- Software may be revised and updated without prior notice.
- Copying of the software or reproduction of this guide in whole or in part by any means is expressly forbidden without the written consent of the manufacturer.
- Steinberg Media Technologies GmbH and Yamaha Corporation make no representations or warranties with regard to the use of the software and documentation and cannot be held responsible for the results of the use of this guide and the software.

Protection of copyright

- Do not use this product for any purpose that may infringe upon the rights of any third party including copyrights, as established by law in each country or region.
- Yamaha bears no responsibility for any infringement upon third party rights that may occur as a result of using this product.
- The copyright of the “content”¹ installed in this product belongs to Steinberg Media Technologies GmbH, Yamaha Corporation, or its copyright holder. Except as permitted by copyright laws and other relevant laws, such as copying for personal use, it is prohibited to “reproduce or divert”² without the permission of the copyright holder. When using the content, consult with a copyright expert. If you create music or perform with the contents through the original use of the product, and then record and distribute them, the permission of Yamaha Corporation is not required regardless of whether the distribution method is paid or free of charge.

*1: The word “content” includes a computer program, audio data, Accompaniment Style data, MIDI data, waveform data, voice recording data, music score, and score data, etc.

*2: The phrase “reproduce or divert” includes taking out the content itself in this product, or recording and distributing it without changes in a similar manner.

Trademarks

The trademarks used in this guide are as follows.

- Steinberg, Cubase, Cubasis and WaveLab Cast are registered trademarks of Steinberg Media Technologies GmbH.
- Windows, Teams and Skype are registered trademarks of Microsoft Corporation in the United States and other countries.
- Apple, Mac, iPad, iPhone, App Store, Lightning and FaceTime are trademarks of Apple Inc., registered in the U.S. and in other countries.
- Android, YouTube, and Google Play are trademarks of Google LLC.

All company names, product names and other such listings in this guide are the registered trademarks or trademarks of their respective companies.

How the manuals are organized

The manuals that cover this product are listed below.

Printed manuals

The manual that is included with this product.

- Quick Guide
Explains the basic methods used to connect this product to external devices and how to configure the settings, as well as the name and function of each part.
- Safety Guide
Explains the safety-related points you must be aware of when using this product.

Online manuals

- User Guide (this guide)
Explains the name and function of each part, how to connect to various devices and how to set things up for making sound. This also explains how to use this product in different situations.

NOTE

You can download these manuals from the Yamaha website. The latest manual data is always available on the Yamaha website, so please make use of these resources as necessary.

<https://download.yamaha.com/>

Product features

This product is a Live Streaming Microphone with mixing functionality, for livestreaming and other uses via connection to your computer, iPad or smartphone.

■ **Features a built-in compressor, equalizer and reverb with adjustable tonal character**

Use the dedicated “AG Controller” to make detailed adjustments to the tonal character. You can turn the reverb on/off on the product itself.

■ **Useful loopback feature for livestreaming**

You can mix the input audio from your computer, iPad or smartphone with the audio from the mic on this product and send it back to your computer, iPad or smartphone.

■ **Attachable to a mic stand or desk-mounted microphone boom arm**

You can remove the stand from this product, and attach this product onto a commercially available mic stand or desk-mounted microphone boom arm.

■ **Bundled with “WaveLab Cast,” useful for podcasting**

A license for “WaveLab Cast” is included with this product. You can use this software for podcasting or for editing the audio in your video contents.

■ **Bundled with “Cubase AI” DAW software**

A license for “Cubase AI” is included with this product. You can use this software for the tasks required in basic music production, including recording, editing, mixing and more.

■ **Operates using USB bus power**

You can connect this product to your computer and power it via USB (a power supply of at least 5 V and 1 A is required).

■ **Optimized mic and preamp**

The preamp of this product is tuned for the microphone capsule, so that you can use the microphone in a wide variety of situations.

Accessories

The following accessories are included with this product.

- USB cable (USB-C to USB-A), 1.5 m × 1
- Safety Guide × 1
- Quick Guide × 1
- WaveLab Cast Download Information × 1
- Cubase AI Download Information × 1

Component names and functions

Front side

The following explains the names and functions of each component on the front of this product.



1 Condenser mic

Used for inputting audio. Speak into the mic with the [☐] mark facing straight toward you.

2 Mic mute [🔇] button

When this is on, the button lights up and the mic is muted (no sound is produced).

3 Mic [🔊] volume knob

Adjusts the mic volume.

4 Reverb [🎚️@REV] button

When this is on, the button lights up and a reverb effect is applied to the audio signal.

5 USB/smartphone [🔊] input volume knob

Adjusts the input audio from a computer that's connected to the USB 2.0 port, or the input audio from a smartphone or other device that's connected to the smartphone input/output jack.

NOTE

You cannot adjust the [AUX] input jack volume by using the USB/smartphone input volume knob. Adjust the volume from the connected device.

6 Headphone [🔊] volume knob

Adjusts the volume for the headphones or earphones connected to the headphones output jack. This has no effect on the volume of audio that's set using the [STREAMING OUT] selector switch on the rear side.

7 Power LED

This lights up when power is being supplied from a [5V DC IN] USB port or a USB 2.0 port.

Rear panel

The following explains the names and functions of each component on the rear side of this product.

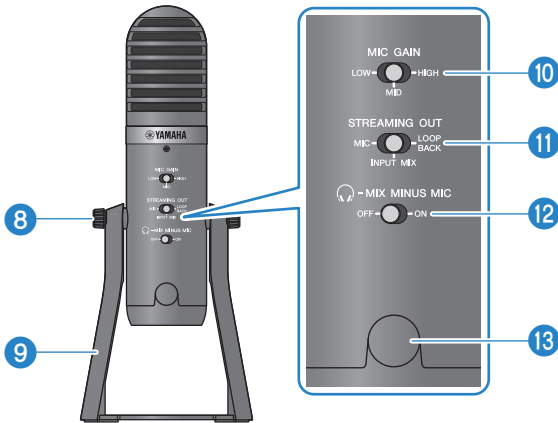

8 Stand attachment screws

Used to remove and attach the 9 stand.

9 Stand

Used for standing this product up. You can remove this stand and attach the mic onto a mic stand or desk-mounted microphone boom arm.

- “How to attach” (p.61)

10 MIC GAIN selector switch

Determines the base mic volume. Set this to [LOW] (low) if the sound is distorting. Set this to [HIGH] (high) if the sound is too low.

11 [STREAMING OUT] selector switch

Selects which audio signal is sent to your iPhone/iPad/computer and to the device connected to the smartphone [] input/output jack.



WARNING

- Adjust the volume before you change the setting of the selector switch on the rear side. This is because the levels may suddenly get loud depending on the device you've connected, which could damage your hearing or cause external devices to malfunction.

[MIC]

Sends only the audio that's inputted into this product.

NOTE

We recommend that you turn the reverb on this product to the OFF setting when you record using DAW software or similar apps, so that only the dry sound is recorded. This gives you more freedom to apply and mix with reverb or other effects in your DAW software after you've recorded the track with the mic.

[INPUT MIX]

This setting is appropriate for broadcasting conversations and speech (voice chats). Sends the audio that's inputted to the [AUX] input jack of this product as a stereo mix.

NOTE

You can connect your smartphone or an instrument such as a guitar or keyboard to the [AUX] input jack, and send the audio mixed with background music or sound effects.

[LOOPBACK]

This setting is appropriate for broadcasting conversations and video game streaming. The [INPUT MIX] audio and the audio input from your iPhone/iPad/computer as well as from a smartphone connected to the smartphone input/output jack is mixed and sent in stereo. This also mixes background music or game sounds that are input from your iPhone/iPad/computer or smartphone.

NOTE

When using DAW software, set this to [MIC] or [INPUT MIX] to avoid feedback.

12 [MIX MINUS MIC] selector switch

When this is set to [OFF], you can hear the audio (your own voice) from this product using headphones. When this is set to [ON], you cannot hear the audio (your own voice) from this product using headphones. Set this to [ON] if you don't want to hear your own voice when doing broadcast commentary or in other live streaming situations.

13 3/8" screw hole for mic stand (with protective cap)

Used for attaching to a mic stand or desk-mounted microphone boom arm. Remove the protective cap before attaching the mic. You will need a 3/8" conversion adapter for attachment.

NOTICE

- Make sure not to lose the protective cap and store it in a safe place.

NOTE

3/8" conversion adapter (recommended product):
König & Meyer 19695 Universal joint - 3/8" male thread

Bottom

The following explains the names and functions of each component on the bottom of this product.

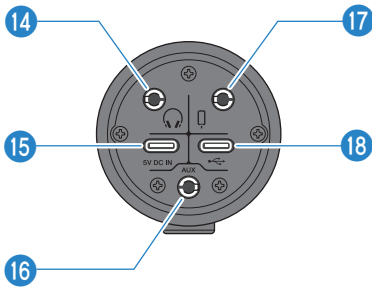

14 **Headphones [🎧] output jack**

Connect your headphones or earphones here. Compatible with 3.5 mm stereo mini-plug cables.

NOTE

Although you can connect Bluetooth earphones with an adapter, latency generally occurs with Bluetooth earphones, which may make them unsuitable for certain purposes.

15 **[5V DC IN] USB port (USB-C)**

Connect a commercially-available USB power adapter, USB mobile battery or similar device here. Use this with devices that cannot supply power like an iPhone or iPad, or when connecting to computers that cannot supply ample bus power. This product does not include a USB power adapter or USB mobile battery.

NOTICE

- Be sure to read the safety precautions for the USB power adapter or USB mobile battery that you will use.
- Use a USB mobile battery or USB power adapter with an output voltage of 4.8 V–5.2 V and an output current of at least 1 A.

16 **[AUX] input jack**

This input jack can be used in many different situations. Compatible with 3.5 mm stereo mini-plug cables. Connect your musical instrument or music player here. You can use a music player to add sound effects such as audio cues or background music. Adjust the volume on the connected device.

17 Smartphone [📱] input/output jack

Compatible with 3.5 mm four-conductor (TRRS) stereo mini-plug cables. Connect Android devices here, such as a smartphone or tablet. You can send the audio signal from this product to the device that's connected.

Stereo mini-plugs compatible with this product

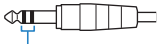
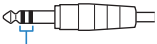
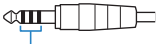
AUX input jack	Headphones jack	Smartphone input/output jack
3-conductor	3-conductor	4-conductor
 <p>Two insulator bands</p>	 <p>Two insulator bands</p>	 <p>Three insulator bands</p>

18 USB 2.0 [🔌] port (USB-C)

Connect your computer or iPhone/iPad here. When connecting a computer, power will be supplied from the computer to this unit. When connecting an iPhone/iPad, connect a USB power adapter (sold separately) to the [5V DC IN] USB port on the bottom.

Follow the important precautions below to prevent device malfunctions or loss of data.

NOTICE

- Do not connect any other devices except for an iPhone, iPad or a computer to the USB 2.0 port.
- Make sure to use the included USB cable when connecting to devices.
- Before inserting or unplugging the USB cable, quit all applications and make sure that no data is being transmitted from this product.
- After you unplug the cable, make sure to wait for at least six seconds before plugging the cable in again. Rapidly plugging in and unplugging the cable may cause a malfunction.

NOTE

At least 5 V and 1 A of power is required to operate on bus power. If a stable power supply cannot be provided, supply power from the [5V DC IN] USB port on the bottom of the unit.

Getting ready to use this product

Connecting to an iPhone/iPad

This explains what to do to power this unit, up through connecting to an iPhone/iPad. An external power supply is required to connect to an iPhone/iPad.

What you need

- USB power adapter or USB mobile battery (at least 5 V, 1 A)
- USB cable (commercially available, for power supply)
- USB cable (included)
- Apple Lightning-USB3 Camera Adapter (when using an iPhone/iPad with a Lightning connector)
- Apple USB-C Digital AV Multiport Adapter (when using an iPad with a USB-C connector)

NOTE

- When using this product for streaming or otherwise using it for long periods of time, have a power supply on hand to power your iPhone/iPad.
- For a list of compatible operating systems, see the following Yamaha website.
<https://www.yamaha.com/2/ag01/>

Connecting

- 1 Make sure that the volume on this product and on the connected device is turned all the way down.**
- 2 Connect a commercially-available USB power adapter, USB mobile battery or similar device to the [5V DC IN] USB port on the bottom of the unit.**

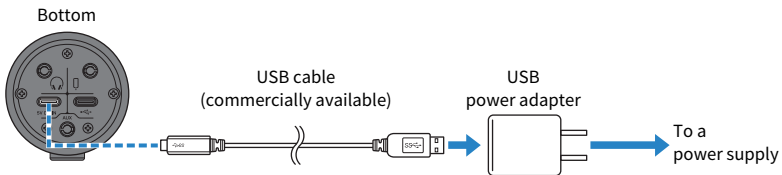

- 3 Check whether the power LED of this product is lit.**

4 Connect this product to an Apple Lightning to USB 3 Camera Adapter using the included USB cable.

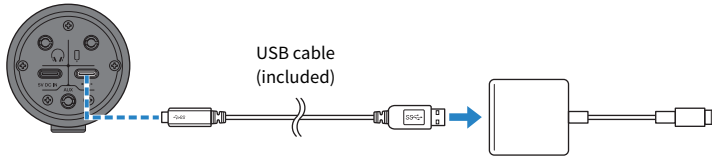

NOTE

If you're using an iPad that has a USB-C connector, use the Apple USB-C Digital AV Multiport Adapter. You can also use the USB-C charging cable included with the iPad to connect directly to this product. However, the amount of time you can use the iPad will be limited by how much battery charge remains.

5 Connect the adapter cable to the iPhone/iPad.

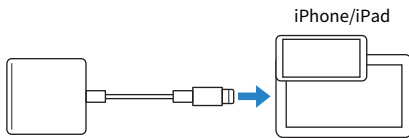

This product is automatically recognized by the iPhone/iPad once connected.

There is no need to configure any settings on the iPhone/iPad.

Connecting to Android devices

This explains what to do to power this unit, up through connecting to an Android device. An external power supply is required to connect to an Android device.

What you need

- USB power adapter or USB mobile battery (at least 5 V, 1 A)
- USB cable (commercially available, for power supply)
- 3.5 mm 4-conductor stereo mini cable

NOTE

- This product can't input/output audio via the USB cable.
- The audio signal sent to the Android device is monaural.
- When using this product for streaming or otherwise using it for long periods of time, have a power supply on hand for powering your Android device.

Connecting

- 1 Make sure that the volume on this product and on the connected device is turned all the way down.**
- 2 Connect a commercially-available USB power adapter, USB mobile battery or similar device to the [5V DC IN] USB port on the bottom of the unit.**

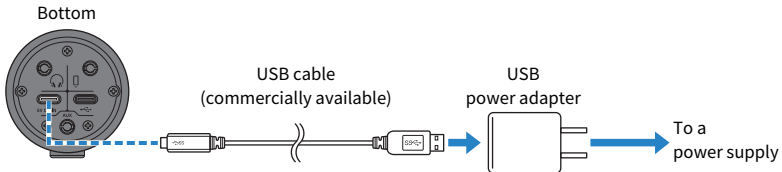

- 3 Check whether the power LED of this product is lit.**
- 4 Using a 3.5 mm four-conductor stereo mini cable, connect the smartphone [📱] input/output jack on this product to the headset jack on your Android device.**

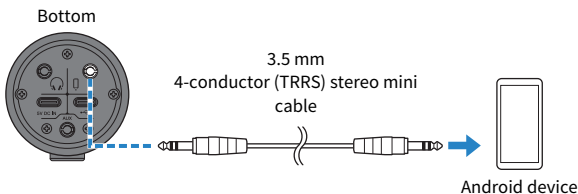

NOTE

- You will need a conversion adapter cable if your Android device does not have a jack for connecting stereo mini plugs. For example, for Android devices that use a USB-C port to input/output audio, you'll need a USB-C to 3.5 mm four-conductor (TRRS) earphone jack conversion adapter cable.
- Use a four-conductor (TRRS) stereo mini cable, not a two- or three-conductor (TS/TRS) cable.

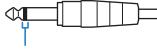
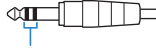
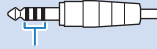
2-conductor (TS)	3-conductor (TRS)	4-conductor (TRRS)
 One insulator band	 Two insulator bands	 Three insulator bands
No	No	Yes

Once connected, use your music playback or recording app to test whether the audio is being inputted and outputted.

Connecting to your computer and configuring the settings (Windows)

First, you will need to download and install the “Yamaha Steinberg USB Driver” from the following website, so that your computer can recognize this product.

<https://www.yamaha.com/2/ag01/>

NOTE

- For the installation steps, see the installation guide found in the compressed folder you downloaded.
- For a list of compatible operating systems, see the Yamaha website listed above.

Connecting

- 1 Remove all USB devices from your computer except for the mouse and keyboard.**
- 2 Make sure that the volume on this product and on the connected device is turned all the way down.**
- 3 After installing the driver, use the included USB cable to connect this product to the computer.**

Connect the devices directly without using a USB hub.

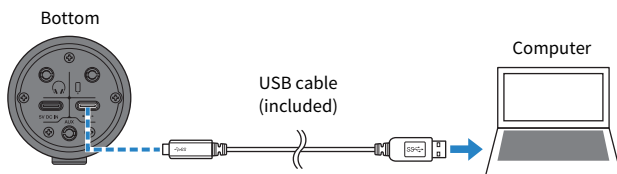

- 4 Check whether the power LED of this product is lit.**

If you've connected the devices before installing the driver, go ahead and install the driver.

Settings on the computer

Change the output/input setting on your computer to “AG01”.

- 1 Open the “Search” box from the “Taskbar”.**

The method of opening the “Search” box may differ depending on the particular computer or OS.

- 2 Type “Sound” into the “Search” box screen, and then select “Sound Settings” from the menu that appears.**

Getting ready to use this product > Connecting to your computer and configuring the settings (Windows)

3 Select [Yamaha AG01] for “Output” and “Input” on the “Sound” screen.

Connecting to your computer and configuring the settings (Mac)

The standard driver supplied with macOS can be used as-is, so there is no need to install the driver.

NOTE

For a list of compatible operating systems, see the following Yamaha website.
<https://www.yamaha.com/2/ag01/>

Connecting

- 1 Remove all USB devices from your computer except for the mouse and keyboard.**
- 2 Make sure that the volume on this product and on the connected device is turned all the way down.**
- 3 Use the included USB cable or the USB-C charging cable that comes with your Mac to connect this product to the computer.**

Connect the devices directly without using a USB hub.

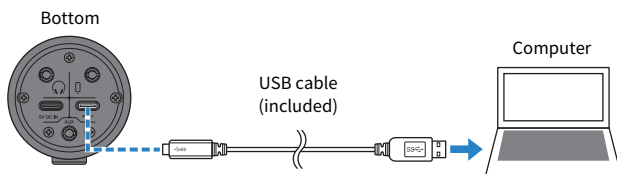

NOTE

For Macs that feature a USB-C connector, use the USB-C charging cable that came with your Mac, or use a commercially available USB-C to USB-C cable.

- 4 Check whether the power LED of this product is lit.**

Settings on the computer

From “Audio MIDI Setup” on the computer, set “Audio Devices” to “AG01”.

- 1 Open “Finder” → “Go” → “Applications” → “Utilities” → “Audio MIDI Setup”.**

The method of opening the settings differs with each computer.

- 2 Select “Yamaha AG01” from the list at the left side of the Audio Devices screen.**

If the Audio Devices screen is not shown, select “Show Audio Devices” from the “Window” menu to make it appear.

- 3** Click  at the bottom left of the screen and select “Use This Device For Sound Output”.
- 4** Similarly, select “Use This Device For Sound Input”.
- 5** Once you’ve finished steps 3 and 4, the mic and speaker icons at the bottom right of “Yamaha AG01” in the list will appear.
- 6** Quit “Audio MIDI Setup.”

Using this product for livestreaming (17LIVE, Twitch, YouTube Live)

Using with an iPhone/iPad

This explains how to use this product with your iPhone/iPad to configure the settings and make the necessary operations to livestream your voice or your singing to 17LIVE, Twitch, YouTube Live or other such services. (17LIVE, Twitch and YouTube Live are the names of streaming apps.)

What you need

- This product
- iPhone/iPad (on which the AG Controller and livestreaming apps are installed)
Search for the “AG Controller” app on the App Store and install it on your iPhone/iPad.
- Headphones or earphones with a stereo mini-plug cable
- Apple Lightning-USB3 Camera Adapter (when using an iPhone/iPad with a Lightning connector)
- Apple USB-C Digital AV Multiport Adapter (when using an iPad with a USB-C connector)
- USB power adapter
- USB cable (commercially available, for power supply)
- USB cable (included)

Steps to follow

1 Connect the iPhone/iPad

Make the necessary connections by referring to “Getting ready to use this product” → “Connecting to an iPhone/iPad”.

- “Connecting to an iPhone/iPad” (p.15)

2 Connect headphones or earphones

Connect your headphones or earphones to the headphones output jack.

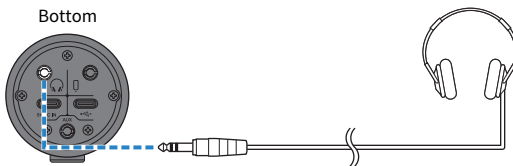

Once you've made all the connections, let's configure the settings for this product.

3 Configure the settings for this product

Make the settings for each switch on the rear as follows.

[MIC GAIN]: [MID]

[STREAMING OUT]: [INPUT MIX]

[🎧-MIX MINUS MIC]: [OFF]

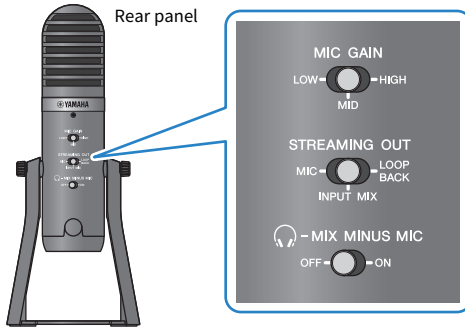

Once you've made the settings on this product, launch the "AG Controller" app and click "Sound Check" at the bottom of the screen. Adjust the volume to check the sound on the Sound Check screen that appears.



4 Adjust the headphone/earphone volume

Using this product for livestreaming (17LIVE, Twitch, YouTube Live) > Using with an iPhone/iPad

- 1 Adjust the mic volume as necessary.**
- 2 Set the headphone [🔊] volume knob to the minimum [0] position.**

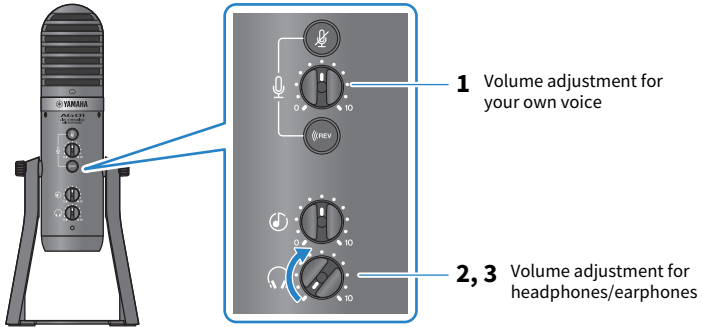

- 3 While speaking into the mic with the [🔊] mark facing straight toward you, adjust the headphone/earphone volume. Adjusting the volume for the headphones or earphones has no effect on the volume of the livestreaming audio.**



5 Adjust the overall volume

Use the mic [🔊] volume knob and the USB/smartphone [🔊] input volume knob to adjust the respective levels.

Launch the livestreaming app and check the balance for the listeners.

NOTE

See “Audio-related and other issues” (p.66) if you don’t hear any sound.

Using this product for livestreaming (17LIVE, Twitch, YouTube Live) > Using this product with an Android device

Using this product with an Android device

This explains how to use this product with your Android device to configure the settings and make the necessary operations to livestream your voice or your singing to 17LIVE, Twitch, YouTube Live or other such services. (17LIVE, Twitch and YouTube Live are the names of streaming apps.)

What you need

- This product
- Android device
- Headphones or earphones with a stereo mini-plug cable
- 3.5 mm 4-conductor stereo mini cable
- USB power adapter
- USB cable (commercially available, for power supply)

Steps to follow

1 Connect to the Android device

Make the necessary connections by referring to “Getting ready to use this product” → “Connecting to Android devices”.

“Connecting to Android devices” (p.17)

2 Connect headphones or earphones

Connect your headphones or earphones to the headphones output jack.

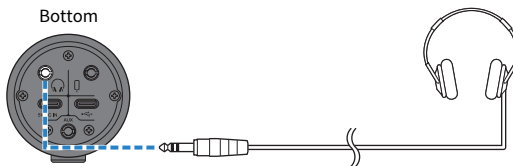

Once you've made all the connections, let's configure the settings for this product.

Using this product for livestreaming (17LIVE, Twitch, YouTube Live) > Using this product with an Android device

3 Configure the settings for this product

Make the settings for each switch on the rear as follows.

[MIC GAIN]: [MID]

[STREAMING OUT]: [INPUT MIX]

[🎧]-MIX MINUS MIC: [OFF]

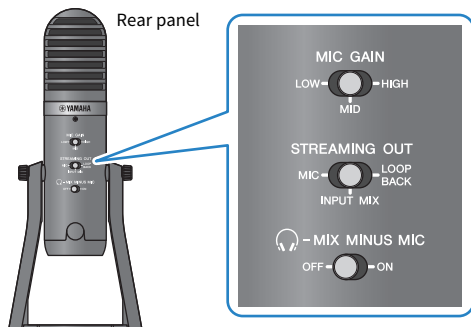

4 Adjust the headphone/earphone volume

1 Adjust the mic volume as necessary.

2 Set the headphone [🎧] volume knob to the minimum [0] position.

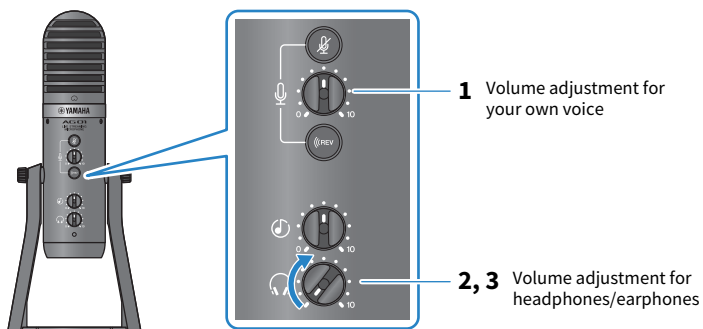

Using this product for livestreaming (17LIVE, Twitch, YouTube Live) > Using this product with an Android device

- 3 While speaking into the mic with the [∞] mark facing straight toward you, adjust the headphone/earphone volume. Adjusting the volume for the headphones or earphones has no effect on the volume of the livestreaming audio.**



5 Adjust the overall volume

Use the mic [🔊] volume knob and the USB/smartphone [🔊] input volume knob to adjust the respective levels.

Launch the livestreaming app and check the balance for the listeners.

NOTE

See “Audio-related and other issues” (p.66) if you don’t hear any sound.

Using this product with your computer

This explains how to use this product with your Windows PC or Mac to configure the settings and make the necessary operations to livestream your voice or your singing to 17LIVE, Twitch, YouTube Live or other such services. (17LIVE, Twitch and YouTube Live are the names of streaming apps.)

What you need

- This product
- Windows PC or Mac (on which the AG Controller and livestreaming apps are installed)
Install the “AG Controller” app from the following website.
<https://www.yamaha.com/2/ag01/>
- Headphones or earphones with a stereo mini-plug cable
- USB cable (included)

Steps to follow

1 Installing the driver (Windows only)

If you are using a Mac, no driver installation is required. Start from step 2.

If the driver hasn't been installed yet, install by referring to “Getting ready to use this product” → “Connecting to your computer and configuring the settings (Windows)”.

- “Connecting to your computer and configuring the settings (Windows)” (p.19)

2 Connecting to your computer

Connect by referring to “Getting ready to use this product” → “Connecting to your computer and configuring the settings (Windows)/(Mac)”.

- “Connecting to your computer and configuring the settings (Windows)” (p.19)
- “Connecting to your computer and configuring the settings (Mac)” (p.21)

3 Connect headphones or earphones

Connect your headphones or earphones to the headphones output jack.

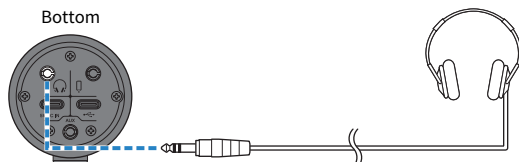

Once you've made all the connections, let's configure the settings for this product.

Using this product for livestreaming (17LIVE, Twitch, YouTube Live) > Using this product with your computer

4 Configure the settings for this product

Make the settings for each switch on the rear as follows.

[MIC GAIN]: [MID]

[STREAMING OUT]: [INPUT MIX]

[🎧-MIX MINUS MIC]: [OFF]

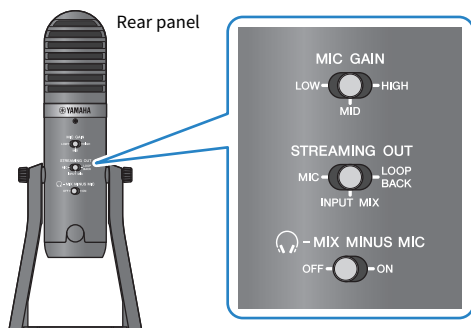

Once you've made the settings on this product, launch the "AG Controller" app and click "Sound Check" at the bottom of the screen. Adjust the volume to check the sound on the Sound Check screen that appears.



5 Adjust the headphone/earphone volume

Using this product for livestreaming (17LIVE, Twitch, YouTube Live) > Using this product with your computer

- 1 Adjust the mic volume as necessary.**
- 2 Set the headphone [🔊] volume knob to the minimum [0] position.**

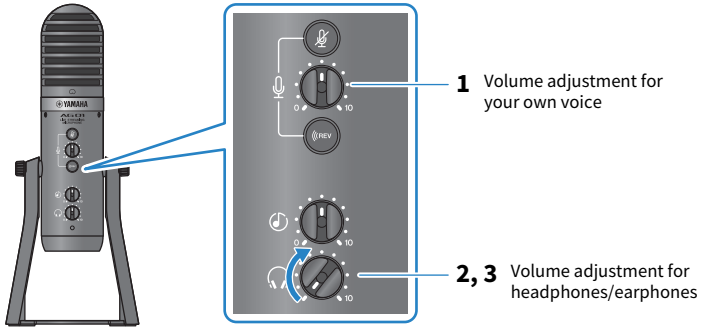

- 3 While speaking into the mic with the [🔊] mark facing straight toward you, adjust the headphone/earphone volume. Adjusting the volume for the headphones or earphones has no effect on the volume of the livestreaming audio.**



6 Adjust the overall volume

Use the mic [🔊] volume knob and the USB/smartphone [🔊] input volume knob to adjust the respective levels.

Launch the livestreaming app and check the balance for the listeners.

NOTE

See “Audio-related and other issues” (p.66) if you don’t hear any sound.

Using this product for livestreaming (17LIVE, Twitch, YouTube Live) > Using this product with your computer

Livestreaming with OBS

Here, we explain how to use OBS, as an example of how to use livestreaming software. To download and install OBS, see the official OBS website.

- 1 Launch OBS, and open the “Settings” screen from “File”.**
- 2 On the left-hand navigation menu, click “Audio”.**
- 3 For the “Desktop Audio” settings in “Global Audio Devices”, use “Default” or “Disabled”.**

If you’ve set the [STREAMING OUT] selector switch on this product to [MIC] or to [INPUT MIX], set this to “Default”; and if you’ve set the selector switch to [LOOPBACK], set this to “Disabled”.
- 4 Also, set the “Mic/Auxiliary Audio” setting in “Global Audio Devices” to the line setting, “Yamaha AG01”.**
- 5 On the left-hand navigation menu, click “Stream”.**
- 6 Select the streaming service to use, and input the stream key as necessary that you received from the service.**
- 7 Close the “Settings” screen.**
- 8 Start the livestream.**

Operations while livestreaming

This explains the operations you can use while livestreaming.

■ Mute the mic

If you will be leaving your seat or otherwise taking a break during the livestream, turn the mic mute [] button on (the LED lights up), so that the sound from the mic is not broadcasted.

■ Adding reverb to your voice

To add reverb to the mic audio, turn the reverb [] button on (the LED lights up).

Using the AG Controller app

To make detailed settings for this product, use the AG Controller app. As an example, here are the settings screens for EQ and reverb.

- EQ settings screen

How to access: [Detail ] -> click on the [EQ] graph for [CH 1] onscreen

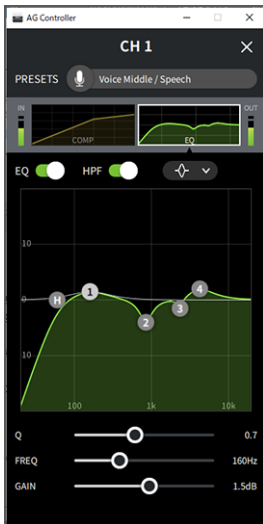

Using this product for livestreaming (17LIVE, Twitch, YouTube Live) > Operations while livestreaming

- Reverb settings screen

How to access: [Detail ►] → click on the [Reverb] graph onscreen

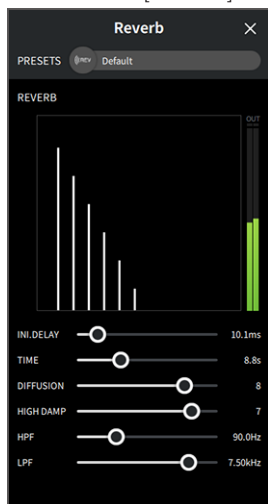

NOTE

The AG Controller app is not available for Android devices.

Using this product for livestreaming (17LIVE, Twitch, YouTube Live) > Connecting your musical instrument or music player

Connecting your musical instrument or music player

This shows you how to connect your musical instrument or music player and configure the settings to add background music or sound effects.

■ Connecting an instrument

Connect your guitar, digital piano, synthesizer or other digital instrument to the [AUX] input jack on the bottom of this unit.

Adjust the volume on the connected musical instrument.

NOTE

You may need a conversion cable, an effects unit or other means to connect your instrument. Check the method for connecting that applies to your instrument.

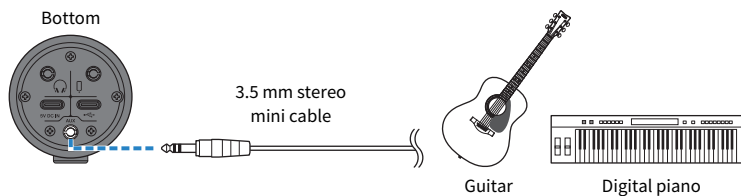

■ Connecting a music player

To play background music or sound effects, connect your music player to the [AUX] input jack at the bottom of this unit.

Adjust the volume on the connected device.

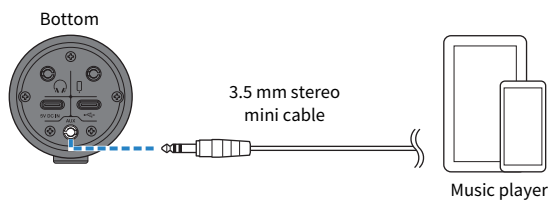

Using this product for game chats (Discord)

Using with an iPhone/iPad

This explains the settings and operations to make when using this product with your iPhone/iPad to hold voice chats while playing games with your friends using Discord or similar apps (“Discord” is the name of an app).

When using your iPhone/iPad for chat-based apps, the sound from this product will not be heard even when connected via USB cable. You’ll need to connect using a 3.5 mm 4-conductor (TRRS) stereo mini cable.

What you need

- This product
- iPhone/iPad (on which Discord is installed)
- Headphones or earphones with a stereo mini-plug cable
- Gaming device
- Lightning - 3.5 mm headphone jack adapter (when using an iPhone/iPad with a Lightning connector. The use of genuine Apple products is recommended.)
- USB - 3.5 mm headphone jack adapter (when using an iPad with a USB-C connector. The use of genuine Apple products is recommended.)
- 3.5 mm 4-conductor (TRRS) stereo mini cable
- USB power adapter
- USB cable (commercially available, for power supply)

Steps to follow

1 Connect the iPhone/iPad

- 1 Make sure that the volume on this product and on the connected device is turned all the way down.**
- 2 Connect a commercially-available USB power adapter, USB mobile battery or similar device to the [5V DC IN] USB port on the bottom of the unit.**
- 3 Plug the Lightning or USB-C 3.5 mm headphone jack adapter into your iPhone/iPad.**

4 Connect the Lightning or USB-C 3.5 mm headphone jack adapter to the smartphone [] input/output jack of this product with a 3.5 mm 4-conductor (TRRS) stereo mini cable.

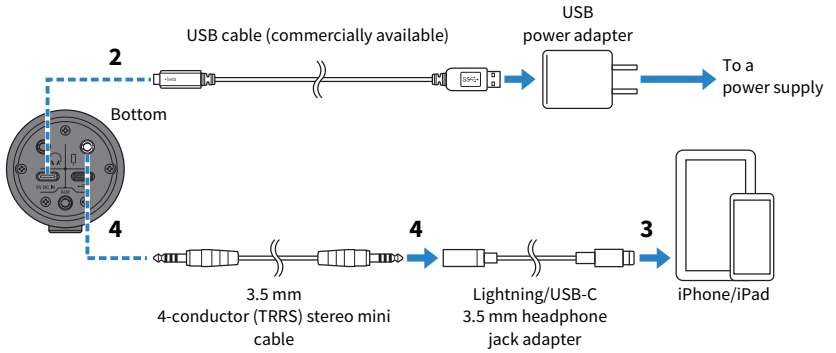

NOTE

Use a four-conductor (TRRS) stereo mini cable, not a two- or three-conductor (TS/TRS) cable.

2-conductor (TS)	3-conductor (TRS)	4-conductor (TRRS)
 One insulator band	 Two insulator bands	 Three insulator bands
No	No	Yes

2 Connect headphones or earphones

Connect your headphones or earphones to the headphones output jack.

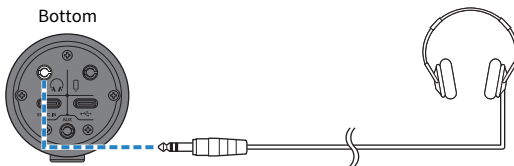

3 Connect your gaming device

Connect the headphones output from your gaming device to the [AUX] input jack.

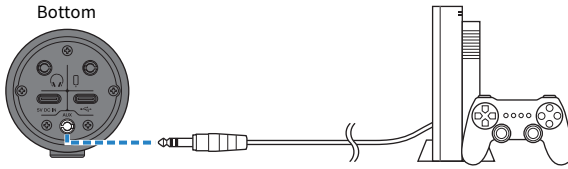

Once you've made all the connections, let's configure the settings for this product.

4 Configure the settings for this product

Make the settings for each switch on the rear as follows.

[MIC GAIN]: [MID]

[STREAMING OUT]: [MIC]

[🎧-MIX MINUS MIC]: [OFF]; set this to [ON] if you don't want to hear your own voice.

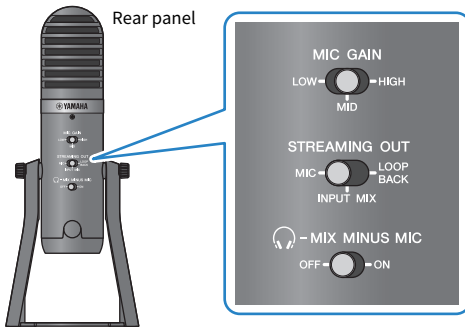

5 Starting the voice chat

- 1 Launch Discord.
- 2 Adjust the volume using the headphone [🎧] volume knob while audio is playing on the gaming device. If the sound coming from the gaming device is too low, turn up the volume on your gaming device.
- 3 Use the USB/smartphone [📱] input volume knob to adjust the volume of the person you're talking with.

Using this product for game chats (Discord) > Using with an iPhone/iPad

4 Use the mic [🔊] volume knob to adjust the volume of your own voice.

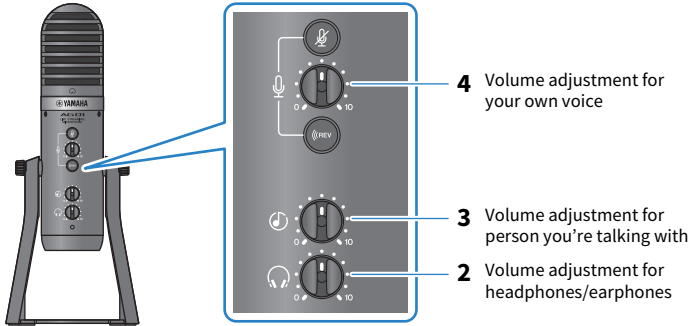

Operations during voice chat

• **Muting your own voice**

If you want to interrupt the voice chat, turn the mic mute [🔇] button on (the LED lights up).

NOTE

See “Audio-related and other issues” (p.66) if you don't hear any sound.

Using this product with an Android device

This explains the settings and operations to make when using this product with your Android device to hold voice chats while playing games with your friends using Discord or similar apps (“Discord” is the name of an app).

NOTE

When using an Android device, the audio from this product cannot be inputted via USB. You'll need to connect using a 3.5 mm 4-conductor (TRRS) stereo mini cable.

What you need

- This product
- Android device (on which Discord is installed)
- Headphones or earphones with a stereo mini-plug cable
- Gaming device
- 3.5 mm 4-conductor (TRRS) stereo mini cable
- USB power adapter
- USB cable (commercially available, for power supply)

Steps to follow

1 Connect to the Android device

Make the necessary connections by referring to “Getting ready to use this product” → “Connecting to Android devices”.

“Connecting to Android devices” (p.17)

2 Connect headphones or earphones

Connect your headphones or earphones to the headphones output jack.

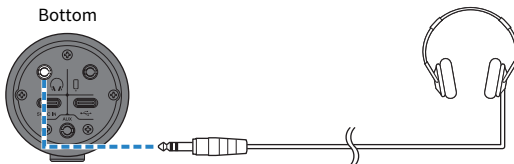

3 Connect your gaming device

Connect the headphones output from your gaming device to the [AUX] input jack.

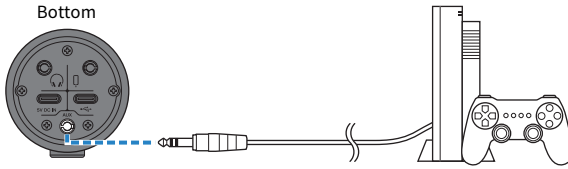

Once you've made all the connections, let's configure the settings for this product.

4 Configure the settings for this product

Make the settings for each switch on the rear as follows.

[MIC GAIN]: [MID]

[STREAMING OUT]: [MIC]

[🎧-MIX MINUS MIC]: [OFF]; set this to [ON] if you don't want to hear your own voice.

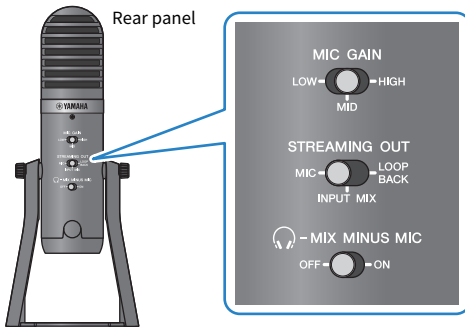

5 Starting the voice chat

- 1 Launch Discord.
- 2 Adjust the volume using the headphone [🎧] volume knob while audio is playing on the gaming device. If the sound coming from the gaming device is too low, turn up the volume on your gaming device.
- 3 Use the USB/smartphone [📱] input volume knob to adjust the volume of the person you're talking with.

Using this product for game chats (Discord) > Using this product with an Android device

4 Use the mic [M] volume knob to adjust the volume of your own voice.

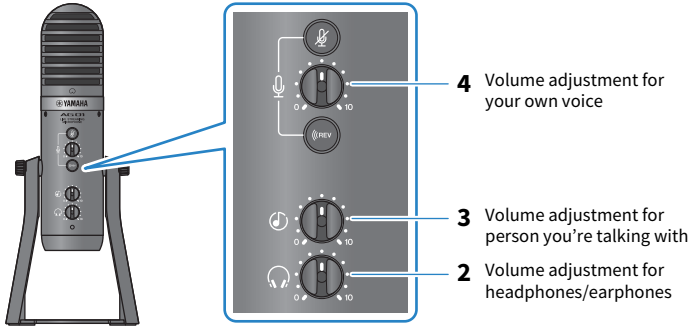

Operations during voice chat

• **Muting your own voice**

If you want to interrupt the voice chat, turn the mic mute [M] button on (the LED lights up).

NOTE

See “Audio-related and other issues” (p.66) if you don't hear any sound.

Using this product with your computer

This explains the settings and operations to make when using this product with your Windows PC or Mac to hold voice chats while playing games with your friends using Discord or similar apps (“Discord” is the name of an app).

What you need

- This product
- Windows PC or Mac (on which Discord is installed)
- Headphones or earphones with a stereo mini-plug cable
- USB cable (included)
- Gaming device
- 3.5 mm stereo mini cable

Steps to follow

1 Installing the driver (Windows only)

If you are using a Mac, no driver installation is required. Start from step 2.

If the driver hasn't been installed yet, install by referring to “Getting ready to use this product” → “Connecting to your computer and configuring the settings (Windows)”.

- “Connecting to your computer and configuring the settings (Windows)” (p.19)

2 Connecting to your computer

Connect by referring to “Getting ready to use this product” → “Connecting to your computer and configuring the settings (Windows)/(Mac)”.

- “Connecting to your computer and configuring the settings (Windows)” (p.19)
- “Connecting to your computer and configuring the settings (Mac)” (p.21)

3 Connect headphones or earphones

Connect your headphones or earphones to the headphones output jack.

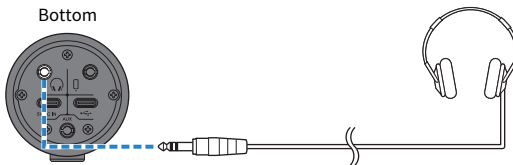

Using this product for game chats (Discord) > Using this product with your computer

4 Connect your gaming device

Connect the headphones output from your gaming device to the [AUX] input jack.

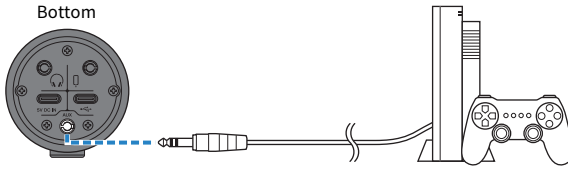

Once you've made all the connections, let's configure the settings for this product.

5 Configure the settings for this product

Make the settings for each switch on the rear as follows.

[MIC GAIN]: [MID]

[STREAMING OUT]: [MIC]

[🎧-MIX MINUS MIC]: [OFF]; set this to [ON] if you don't want to hear your own voice.

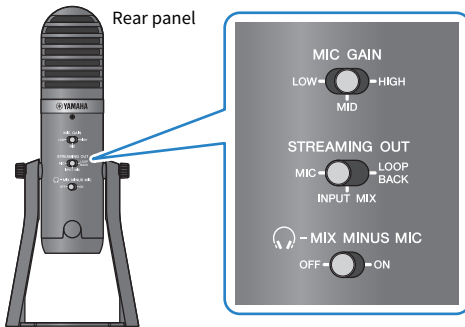

6 Configure the settings for Discord

Log in after launching Discord.

Confirm that the “Audio Settings” sound input device and sound output device are both set to “Yamaha AG01”.

7 Starting the voice chat

- 1 Adjust the volume using the headphone [🎧] volume knob while audio is playing on the gaming device. If the sound coming from the gaming device is too low, turn up the volume on your gaming device.**
- 2 Use the USB/smartphone [📱] input volume knob to adjust the volume of the person you're talking with.**

Using this product for game chats (Discord) > Using this product with your computer

3 Use the mic [M] volume knob to adjust the volume of your own voice.

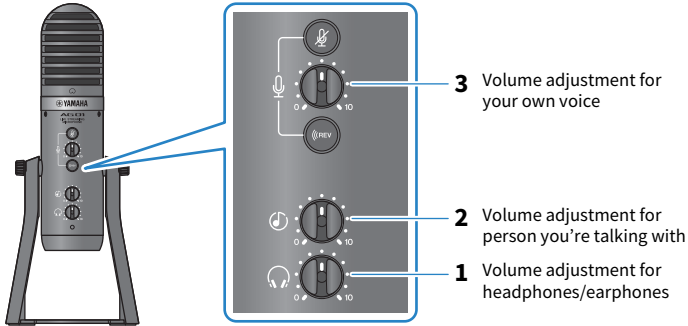

Operations during voice chat

• **Muting your own voice**

If you want to interrupt the voice chat, turn the mic mute [M] button on (the LED lights up).

NOTE

See “Audio-related and other issues” (p.66) if you don't hear any sound.

Using this product in a Web meeting

Using with an iPhone/iPad

This explains the settings and operations to make when using this product with your iPhone/iPad to hold Web meetings with apps such as Zoom, Skype, Teams, FaceTime and LINE. (Zoom, Skype, Teams, FaceTime and LINE are the names of apps.) When using your iPhone/iPad for Skype, FaceTime and LINE, the sound from this product will not be heard even when connected via USB cable. You'll need to connect using a 3.5 mm 4-conductor (TRRS) stereo mini cable.

What you need

- This product
- iPhone/iPad (on which the various apps to use are installed)
- Lightning - 3.5 mm headphone jack adapter (when using an iPhone/iPad with a Lightning connector. The use of genuine Apple products is recommended.)
- USB - 3.5 mm headphone jack adapter (when using an iPad with a USB-C connector. The use of genuine Apple products is recommended.)
- Headphones or earphones with a stereo mini-plug cable
- 3.5 mm 4-conductor stereo mini cable
- USB power adapter
- USB cable (commercially available, for power supply)

Steps to follow

1 Connect the iPhone/iPad

- 1** Make sure that the volume on this product and on the connected device is turned all the way down.
- 2** Connect a commercially-available USB power adapter, USB mobile battery or similar device to the [5V DC IN] USB port on the bottom of the unit.
- 3** Plug the Lightning or USB-C 3.5 mm headphone jack adapter into your iPhone/iPad.

4 Connect the Lightning or USB-C 3.5 mm headphone jack adapter to the smartphone [] input/output jack of this product with a 3.5 mm 4-conductor (TRRS) stereo mini cable.

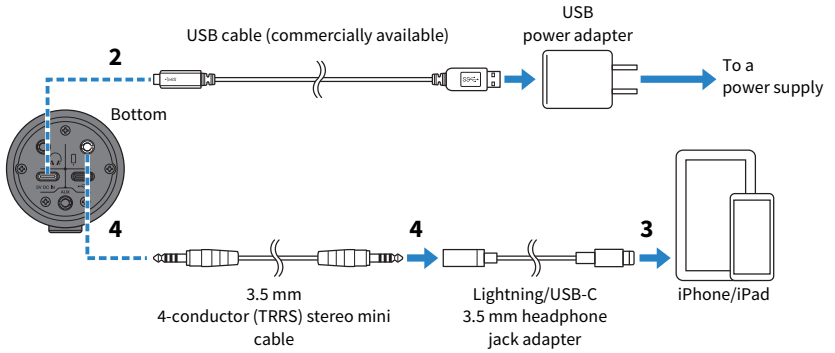

NOTE

Use a four-conductor (TRRS) stereo mini cable, not a two- or three-conductor (TS/TRS) cable.

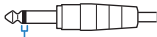
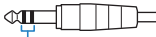
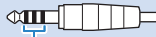
2-conductor (TS)	3-conductor (TRS)	4-conductor (TRRS)
 One insulator band	 Two insulator bands	 Three insulator bands
No	No	Yes

2 Connect headphones or earphones

Connect your headphones or earphones to the headphones output jack.

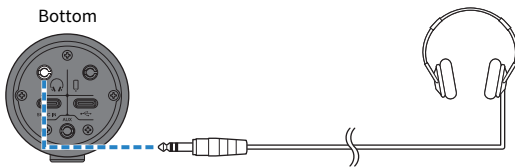

3 Configure the settings for this product

Make the settings for each switch on the rear as follows.

[MIC GAIN]: [MID]

[STREAMING OUT]: [MIC]

[🔇]-MIX MINUS MIC: [OFF]; set this to [ON] if you don't want to hear your own voice.

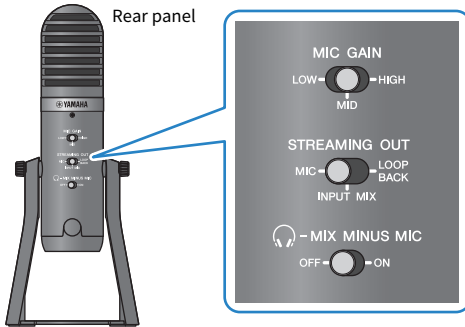

4 Start the Web meeting.

- 1 Set the USB/smartphone [🔊] input volume knob to the 3-o'clock position.
- 2 Launch the Web meeting app you will use.
- 3 Use the USB/smartphone [🔊] input volume knob to adjust the volume of the conversation.
- 4 Adjust the volume for the headphones or earphones using the headphone [🔊] volume knob.
- 5 Use the mic [🔇] volume knob to adjust the volume of your own voice.

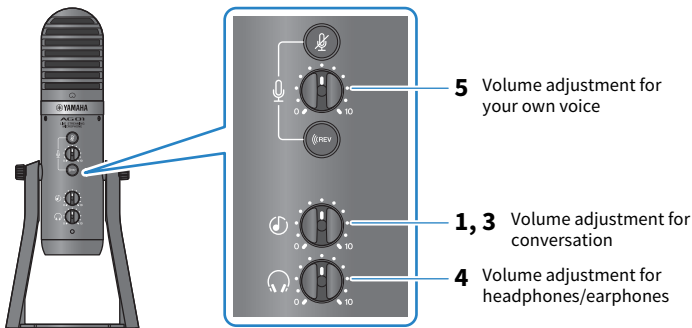

Operations during the conversation

• Muting your own voice

If you want to interrupt the conversation, turn the mic mute [🔇] button on (the LED lights up).

Using this product in a Web meeting > Using with an iPhone/iPad

NOTE

See “Audio-related and other issues” (p.66) if you don’t hear any sound.

Using this product with an Android device

This explains the settings and operations to make when using this product with your Android device to hold Web meetings with apps such as Zoom, Skype, Teams, FaceTime and LINE. (Zoom, Skype, Teams, FaceTime and LINE are the names of apps.)

NOTE

When using an Android device, the audio from this product cannot be inputted via USB. You'll need to connect using a 3.5 mm 4-conductor (TRRS) stereo mini cable.

What you need

- This product
- Android device (on which the various apps to use are installed)
- Headphones or earphones with a stereo mini-plug cable
- 3.5 mm 4-conductor (TRRS) stereo mini cable
- USB power adapter
- USB cable (commercially available, for power supply)

Steps to follow

1 Connect to the Android device

Make the necessary connections by referring to “Getting ready to use this product” → “Connecting to Android devices”.

“Connecting to Android devices” (p.17)

2 Connect headphones or earphones

Connect your headphones or earphones to the headphones output jack.

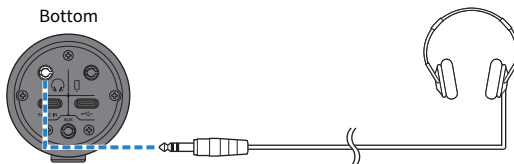

3 Configure the settings for this product

Make the settings for each switch on the rear as follows.

[MIC GAIN]: [MID]

[STREAMING OUT]: [MIC]

[🎧-MIX MINUS MIC]: [OFF]; set this to [ON] if you don't want to hear your own voice.

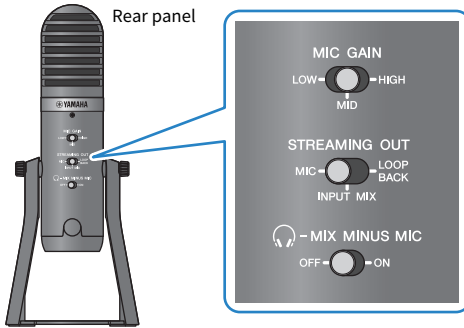

4 Start the Web meeting.

- 1 Set the USB/smartphone [🎧] input volume knob to the 3-o'clock position.
- 2 Launch the Web meeting app you will use.
- 3 Use the USB/smartphone [🎧] input volume knob to adjust the volume of the conversation.
- 4 Adjust the volume for the headphones or earphones using the headphone [🎧] volume knob.
- 5 Use the mic [🎤] volume knob to adjust the volume of your own voice.

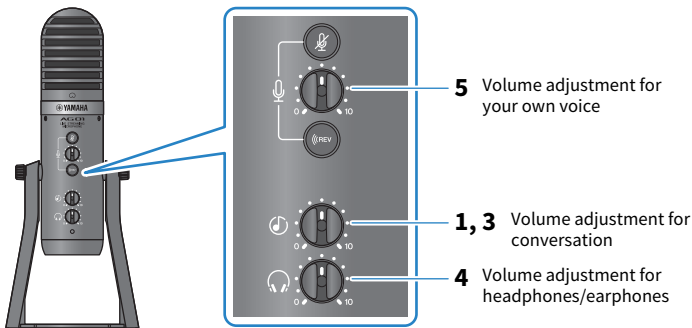

Operations during the conversation

• Muting your own voice

If you want to interrupt the conversation, turn the mic mute [🎤] button on (the LED lights up).

Using this product in a Web meeting > Using this product with an Android device

NOTE

See “Audio-related and other issues” (p.66) if you don’t hear any sound.

Using this product with your computer

This explains the settings and operations to make when using this product with your Windows PC or Mac to hold Web meetings using Zoom, Skype, Teams, FaceTime or LINE. (Zoom, Skype, Teams, FaceTime and LINE are the names of apps.)

What you need

- This product
- Windows PC or Mac (on which the various apps to use are installed)
- Headphones or earphones with a stereo mini-plug cable
- USB cable (included)

Steps to follow

1 Installing the driver (Windows only)

If you are using a Mac, no driver installation is required. Start from step 2.

If the driver hasn't been installed yet, install by referring to "Getting ready to use this product" → "Connecting to your computer and configuring the settings (Windows)".

- "Connecting to your computer and configuring the settings (Windows)" (p.19)

2 Connecting to your computer

Connect by referring to "Getting ready to use this product" → "Connecting to your computer and configuring the settings (Windows)/(Mac)".

- "Connecting to your computer and configuring the settings (Windows)" (p.19)
- "Connecting to your computer and configuring the settings (Mac)" (p.21)

3 Connect headphones or earphones

Connect your headphones or earphones to the headphones output jack.

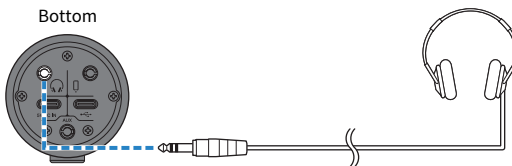

4 Configure the settings for this product

Make the settings for each switch on the rear as follows.

[MIC GAIN]: [MID]

[STREAMING OUT]: [MIC]

[🎧-MIX MINUS MIC]: [OFF]; set this to [ON] if you don't want to hear your own voice.

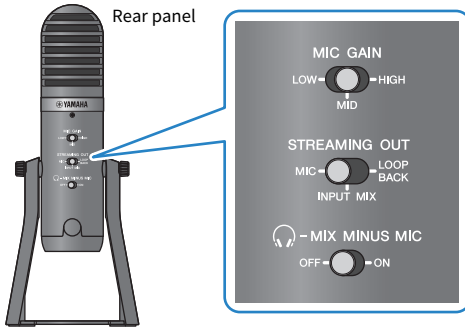

5 Configure the settings for the app

Launch the app you'll use to hold the Web meeting, open the device settings in the app and confirm that the sound input device and sound output device are both set to "Yamaha AG01".

6 Start the Web meeting.

- 1 Use the USB/smartphone [🔊] input volume knob to adjust the volume of the conversation. Set this to the 3-o'clock setting to begin.
- 2 Adjust the volume for the headphones or earphones using the headphone [🎧] volume knob.
- 3 Use the mic [🎤] volume knob to adjust the volume of your own voice.

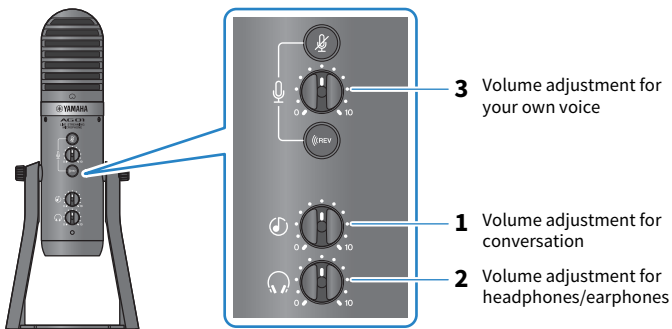

Using this product in a Web meeting > Using this product with your computer

Operations during the conversation

- **Muting your own voice**

If you want to interrupt the conversation, turn the mic mute [] button on (the LED lights up).

NOTE

See “Audio-related and other issues” (p.66) if you don't hear any sound.

Using this product for a podcast

Using WaveLab Cast

WaveLab Cast is an app for Windows and Mac that's optimal for producing podcast audio/video contents. The app allows you to easily record, edit and stream your content.

WaveLab Cast setup:

Refer to the following page to download the app and activate the license.

<https://www.steinberg.net/getwavelabcast>

NOTE

You will need a download access code to download this app. This code is listed on the printed WaveLab Cast Download Information that's included with this product.

The WaveLab Cast manual can be obtained by searching at the following website.

<https://steinberg.help/>

Using this product for recording

Using Rec'n'Share with an iPhone/iPad

Use the Rec'n'Share app in combination with this product to record and edit audio and so on. The Rec'n'Share app makes it easy to do everything from performing and recording your favorite songs to recording and editing video of your performance, up through uploading the results.

For more details on Rec'n'Share, see the following website.

https://www.yamaha.com/2/rec_n_share/

NOTE

- Check the App Store to see which OS versions are compatible with the app.
- Data that can be uploaded is limited to your own original songs, sounds and content for which usage rights have been granted.

Using Cubase AI with your computer

Use Cubase AI in combination with this product to record and edit audio and so on. Cubase AI is DAW software for music production that lets you record, playback and edit audio using your computer.

Cubase AI setup:

Refer to the following page to download the app and activate the license.

<https://www.steinberg.net/getcubaseai>

NOTE

You will need a download access code to download this app. This code is listed on the printed Cubase AI Download Information that's included with this product.

The Cubase AI manual can be obtained by searching at the following website.

<https://steinberg.help/>

Using this product in music production

Using Cubasis LE with an iPhone/iPad

Use Cubasis LE in combination with this product to record and edit audio. Cubasis LE is a basic version of the mobile DAW Cubasis. As with Cubasis, this is a music production app that lets you record, play back and edit audio from your iPhone/iPad.

To use this app, search for and download “Cubasis LE” from the App Store.

For more details on Cubasis LE, see the following Steinberg website.

<https://www.steinberg.net/getcubasisle>

Using Cubase AI with your computer

Use Cubase AI in combination with this product to record and edit audio and so on. Cubase AI is DAW software for music production that lets you record, playback and edit audio using your computer.

Cubase AI setup:

Refer to the following page to download the app and activate the license.

<https://www.steinberg.net/getcubaseai>

NOTE

You will need a download access code to download this app. This code is listed on the printed Cubase AI Download Information that's included with this product.

The Cubase AI manual can be obtained by searching at the following website.

<https://steinberg.help/>

Attaching this product onto a mic stand or desk-mounted microphone boom arm

How to attach

This explains how to attach this product onto a commercially-available mic stand or desk-mounted microphone boom arm.

What you need

- This product
- Mic stand or desk-mounted microphone boom arm
- 3/8" conversion adapter:
König & Meyer 19695 Universal joint - 3/8" male thread recommended

Follow the important precautions below to prevent damage to your device or personal injury.



CAUTION

- Do not attach or remove this product on or from an unstable surface.
- Be sure to unplug all cables from this product before attaching.
- Make sure to support this product with your hand while loosening or tightening the screws before attachment or removal.
- Firmly attach this product onto the mic stand or desk-mounted microphone boom arm.

- 1 Remove the screw and washer by turning the screw while supporting this product with your hand.**

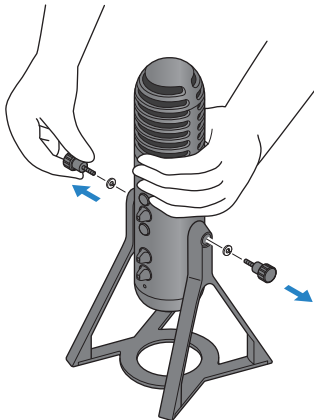

Attaching this product onto a mic stand or desk-mounted microphone boom arm > How to attach

2 Remove this product from the stand by slightly widening the stand.

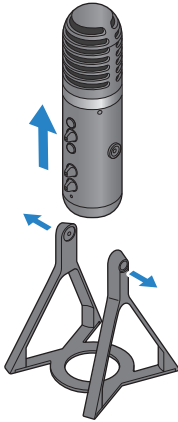

3 Remove the spacers on either side of this product, as well as the protective cap covering the screw hole on the rear side.

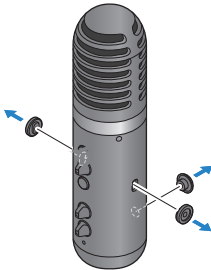

4 Attach the adapter to the mic stand or desk-mounted microphone boom arm.

NOTE

Use a mic stand or desk-mounted microphone boom arm that is compatible with a 3/8" diameter screw hole.

Attaching this product onto a mic stand or desk-mounted microphone boom arm > How to attach

5 Attach this product onto the adapter.

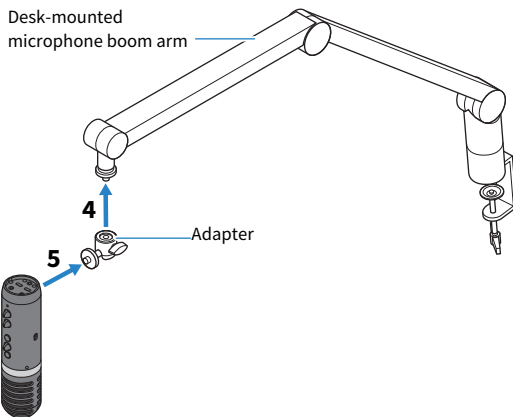
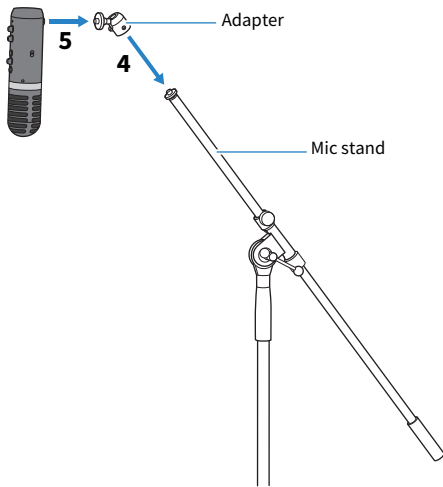

Once you've made sure that the product is securely attached, you're finished.

NOTE

Make sure not to lose the screws, spacers and protective cap that you removed, and store them in a safe place.

Attaching this product onto a mic stand or desk-mounted microphone boom arm > Reattaching the stand for this product

Reattaching the stand for this product

Follow the important precautions below to prevent damage to your device or personal injury.



CAUTION

- Do not attach or remove this product on or from an unstable surface.
- Be sure to unplug all cables from this product before attaching.
- Make sure to support this product with your hand while loosening or tightening the screws before attachment or removal.

When removing this product from the mic stand or desk-mounted microphone boom arm and attaching it again to the stand, follow the steps for “How to attach” (p.61) in reverse order.

When attaching the spacers onto this unit, make sure to line them up with the holes on this unit and attach them firmly.

Troubleshooting

Power-related

The power LED will not light up

● Is the power of this product turned on?

The LED will not light up if this product is not turned on.

- **When using an iPhone, iPad or Android device:** An external power supply is required, such as a USB power adapter or USB mobile battery. You'll need a USB power adapter or USB mobile battery that can output at least 5 V and 1 A of power.
- **When using a Windows PC, Mac or iPad (USB-C connector):** The unit operates on USB power (at least 5 V and 1 A). If the power LED will not light up, there may not be enough bus power. Connect a separate USB power adapter, USB mobile battery or similar device to supply external power.

The power LED is flashing, or lights only intermittently

● There might be a problem with the power supply.

- The LED flashes when there is some kind of problem with the power supply. Connect a commercially-available USB power adapter or USB mobile battery to the [5V DC IN] USB port to supply power.

● Are you using the appropriate USB cable?

- Make sure to use the included USB cable.
- When directly connecting the USB-C port of your iPad or computer to this product, you'll need either the USB-C charging cable that was included with the iPad, or a commercially available USB-C to USB-C cable.

Audio-related and other issues

I can't hear the audio from this product, or no sound is outputted.

● Are you using the appropriate settings for the switch on the rear?

- When the [MIX MINUS MIC] selector switch is set to [ON], you cannot hear the audio (your own voice) from this product using headphones or earphones. In this case, set this to [OFF].
- Set the [MIC GAIN] selector switch to [MID] or [HIGH].

● Is your mic volume set to “0”?

- You won't be able to hear audio from this product if the mic volume knob is set to “0” (zero). Turn the knob to raise the volume.

Feedback

● Is the volume for the mic or headphones/earphones adjusted appropriately?

- If you hear a low pulsating or a high-pitched screeching sound (feedback), lower the volume on your mic, headphones or earphones.

Cannot adjust the volume

● Are you adjusting the volume of the [AUX] input jack on the connected device?

- You cannot adjust the [AUX] input jack volume by using the USB/smartphone input audio knob. Adjust the volume from the connected device.

Windows PC is not recognized

● Have you installed the driver?

- You must install the Yamaha Steinberg USB Driver if you wish to connect this product to a Windows PC. See the following website for how to install the Yamaha Steinberg USB Driver.
<https://www.yamaha.com/2/ag01/>

Appendix

General specifications

0 dBu = 0.775 Vrms, Output impedance of signal generator (Rs) = 150 Ω

All level controls are nominal if not specified.

Frequency response	Microphone preamp input → PHONES OUT via USB IN/OUT	+0.5 dB/-1.5 dB (20 Hz to 20 kHz @ Fs = 192 kHz) with a nominal output level reference @ 1 kHz, MIC GAIN: MID, STREAMING OUT: MIC
Total harmonic distortion *1 (THD+N)	Microphone preamp input to PHOENS OUT	0.1 % @ -2.0 dBu (50 Hz to 20 kHz), MIC GAIN: MID 0.01 % @ +0.0 dBu (1 kHz), MIC GAIN: MID
Hum and noise *2 (20 Hz to 20 kHz)	Residual output noise	-103 dBu (PHONES knob: Min)
Crosstalk (1 kHz) *3		-80 dB
Input channels		Microphone: 1 AUX: 1, USB IN: 1, Smartphone IN: 1
Output channels		PHONES: 1 USB OUT: 1, Smartphone OUT: 1
Microphone function	GAIN	HIGH, MID, LOW
	DSP	COMP/EQ *4, REVERB, MUTE
USB audio	2 IN / 2 OUT	Sampling frequency: up to 192 kHz, Bit depth: 24-bit
Power requirements		DC 5V, 900 mA
Power consumption		Max. 4.5 W
Dimensions (W×H×D)		116 mm × 281 mm × 118 mm (4.6" x 11.1" x 4.6")
Net weight		1.2 kg (2.6 lb)
Included accessories		USB2.0 Cable (1.5 m), Quick Guide, Safety Guide, Wavelab Cast Download Information, Cubase AI Download Information
Operating temperature		0 to +40°C

*1 THD+N is measured with 22 kHz LPF.

*2 Noise is measured with A-weighting filter.

*3 Crosstalk is measured with 1 kHz band pass filter. PHONES OUT L / R.

*4 Setting by AG Controller.

The contents of this guide apply to the latest specifications as of the publishing date.

Microphone specifications

Type	Back electret condenser type
Polar pattern	Cardioid
Address type	Side
Frequency response	30 Hz to 20 kHz
Max. Input SPL	110 dB (THD \leq 1.0% at 1kHz)
Sensitivity	-34 dB \pm 3 dB (0 dB=1 V/Pa, at 1 kHz)

The contents of this guide apply to the latest specifications as of the publishing date.

Input / Output characteristics

Analog Input Characteristics

0 dBu = 0.775 Vrms

Input Jacks	Actual Load Impedance	For Use With Nominal	Input level			Connectors
			Sensitivity*1	Nominal	Max. before clip	
AUX	10 k Ω	600 Ω line	-14 dBu (154.6 mV)	-8 dBu (308.5 mV)	+2 dBu (975.7 mV)	3.5 mm phone jack *2
SMARTPHONE	10 k Ω	600 Ω line	-14 dBu (154.6 mV)	-8 dBu (308.5 mV)	+2 dBu (975.7 mV)	3.5 mm phone jack *3 (CTIA)

*1 Sensitivity is the lowest level that will produce an output of +0 dBu (0.775 V) or the nominal output level when the unit is set to maximum gain. (All level controls are at their maximum position.)

*2 Tip = Signal L, Ring = Signal R, Sleeve = GND

*3 Tip = Signal L, Ring 1 = Signal R, Ring 2 = GND, Sleeve = Output for smartphone

Analog Output Characteristics

0 dBu = 0.775 Vrms

Output Terminals	Actual Source Impedance	For Use With Nominal	Output level		Connectors
			Nominal	Max. before clip	
SMARTPHONE (OUT)	150 Ω	1.5 k Ω line	-30 dBu (24.51 mV)	-20 dBu (77.5 mV)	3.5 mm phone jack *3 (CTIA)
PHONES	120 Ω	40 Ω phone	1.5 mW + 1.5 mW	6 mW + 6 mW	3.5 mm phone jack

*3 Tip = Signal L, Ring 1 = Signal R, Ring 2 = GND, Sleeve = Output for smartphone

Digital Input / Output Characteristics

Terminals	Format	Data Length	Fs	Connector
USB	USB Audio Class 2.0 / Yamaha Steinberg USB Driver	24-bit	44.1 kHz, 48 kHz, 88.2 kHz, 96 kHz, 176.4 kHz, 192 kHz	USB Type-C

The contents of this guide apply to the latest specifications as of the publishing date.

Dimensions

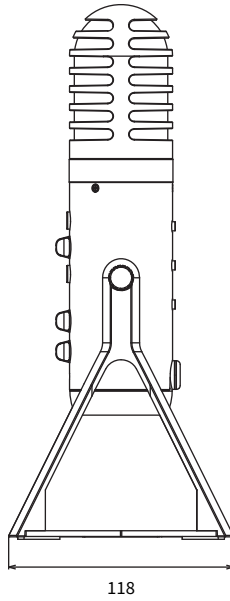
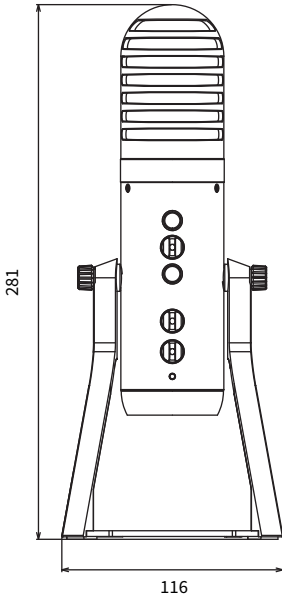

(Unit: mm)

Polar pattern

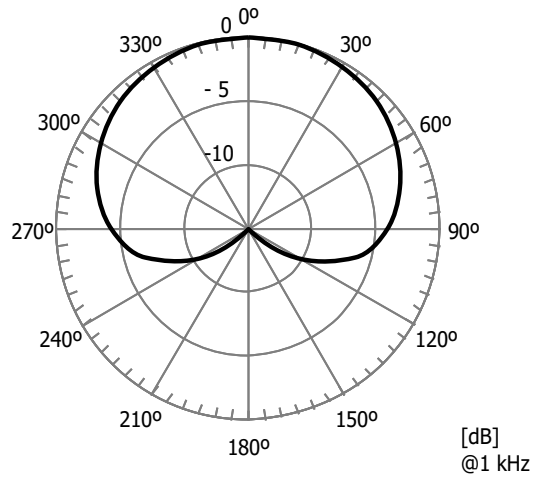

Frequency response

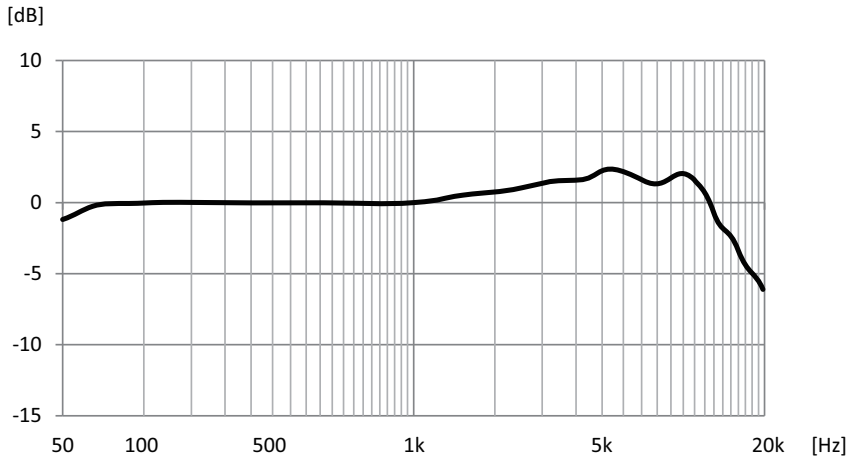

Block and level diagrams

See the following Yamaha website for the AG01 block and level diagrams.

<https://www.yamaha.com/2/ag01/>

Yamaha Pro Audio global website
<https://www.yamahaproaudio.com/>

Yamaha Downloads
<https://download.yamaha.com/>

© 2022 Yamaha Corporation

Published 04/2022 AM-B0