

# JUNO-X

## Reference Manual

# Contents

<b>An Overview of the JUNO-X</b> .....	<b>4</b>
◇ <b>Basic Structure</b> .....	<b>4</b>
Tone .....	<b>4</b>
Part .....	<b>5</b>
Scene .....	<b>5</b>
I-ARPEGGIO .....	<b>5</b>
System .....	<b>5</b>
Controllers .....	<b>5</b>
Interface .....	<b>5</b>
<b>Panel Descriptions</b> .....	<b>6</b>
◇ <b>Top Panel</b> .....	<b>6</b>
◇ <b>Rear Panel</b> (Connecting Your Equipment) .....	<b>10</b>
◇ <b>Front Panel</b> (Connecting Your Equipment) .....	<b>10</b>
<b>Getting Ready to Play</b> .....	<b>11</b>
◇ <b>Placing the JUNO-X on a Stand</b> .....	<b>11</b>
◇ <b>Turning the Power on and Adjusting the Volume</b> ....	<b>11</b>
Turning the Power off .....	<b>11</b>
◇ <b>Using the Built-In Speakers</b> .....	<b>12</b>
<b>Selecting a Sound</b> .....	<b>13</b>
◇ <b>Selecting a Scene</b> (Scene Select Mode) .....	<b>13</b>
Switching Between Scene Banks and Selecting Scenes .....	<b>13</b>
◇ <b>Selecting a Tone</b> (Tone Select Mode) .....	<b>14</b>
Registering to a Model Bank and Selecting a Tone .....	<b>14</b>
◇ <b>Selecting a Part</b> (Part Select Mode) .....	<b>15</b>
Showing the Part Setting Status List .....	<b>15</b>
Selecting the Part to Edit (Current Part) .....	<b>15</b>
Selecting the Parts to Perform .....	<b>15</b>
Assigning Functions to the [4]–[13] Buttons .....	<b>15</b>
<b>Playing</b> .....	<b>16</b>
◇ <b>Performing Arpeggios</b> .....	<b>16</b>
◇ <b>Layering Tones and Splitting the Keyboard</b> .....	<b>16</b>
◇ <b>Specifying the Key Range</b> .....	<b>16</b>
◇ <b>Using the Controllers</b> .....	<b>17</b>
◇ <b>Performing with a Connected Mic</b> (Vocoder) .....	<b>17</b>
Adjusting the Mic .....	<b>17</b>
◇ <b>Performing with a Connected Computer or Other External Device</b> .....	<b>17</b>
<b>I-ARPEGGIO</b> .....	<b>18</b>
Basic Methods of Operation .....	<b>18</b>
Other Operation .....	<b>18</b>
◇ <b>Using the Step Edit Function</b> .....	<b>20</b>
Editing Each Step of the Arpeggio Performance (STEP EDIT) .....	<b>20</b>
Playing a Pattern You Entered .....	<b>21</b>
◇ <b>If the Keyboard Does Not Play Sound</b> .....	<b>21</b>

<b>Editing a Scene</b> (SCENE EDIT) .....	<b>22</b>
◇ <b>Scene Edit/Part Edit</b> .....	<b>22</b>
Configuring Scene Common Settings (Scene Edit) .....	<b>22</b>
Configuring the Performance Style, Controllers and Other Settings (Part Edit) .....	<b>23</b>
◇ <b>Saving the Scene Settings</b> (SCENE WRITE) .....	<b>24</b>
◇ <b>Using the Scene Lock Function</b> .....	<b>24</b>
◇ <b>Initializing a Scene</b> (SCENE INITIALIZE) .....	<b>24</b>
<b>Editing a Tone</b> (TONE EDIT) .....	<b>25</b>
◇ <b>Editing a Tone</b> (TONE EDIT Screen) .....	<b>25</b>
Editing Basic Settings for the Tone (TONE COMMON EDIT) .....	<b>26</b>
Editing the Parameters of Each Section (TONE EDIT) .....	<b>26</b>
Editing the Effects (TONE MFX) .....	<b>26</b>
Duplicating a Partial (PARTIAL COPY) .....	<b>26</b>
◇ <b>Saving the Tone Settings</b> (TONE WRITE) .....	<b>26</b>
◇ <b>Initializing a Tone</b> (TONE INITIALIZE) .....	<b>26</b>
<b>Correspondence Between Controllers and Parameters</b> .....	<b>27</b>
◇ <b>JUNO-X</b> .....	<b>27</b>
◇ <b>JUNO-106</b> .....	<b>28</b>
◇ <b>JUNO-60</b> .....	<b>29</b>
◇ <b>XV-5080, RD-PIANO, and Other Tones (When the [SCENE] Button Is Lit)</b> .....	<b>30</b>
◇ <b>XV-5080, RD-PIANO, and Other Tones (When the [MODEL BANK] Button Is Lit)</b> .....	<b>32</b>
◇ <b>Controllers Common to All Models</b> .....	<b>34</b>
◇ <b>MFX Assign Parameters</b> .....	<b>36</b>
<b>Using the Bluetooth® Functionality</b> .....	<b>37</b>
◇ <b>Using the Speakers of the JUNO-X to Play Music from a Mobile Device</b> .....	<b>37</b>
Registering a Mobile Device with This Instrument (Pairing) ....	<b>37</b>
Connecting an Already-Paired Mobile Device .....	<b>37</b>
Playing Music from a Mobile Device .....	<b>37</b>
◇ <b>Using Apps That Support Bluetooth MIDI</b> .....	<b>37</b>
◇ <b>Differentiating Multiple JUNO-X Units</b> (Bluetooth ID) ...	<b>38</b>
<b>Control</b> .....	<b>39</b>
◇ <b>Connecting a Computer</b> .....	<b>39</b>
Installing the Dedicated Driver .....	<b>39</b>
Using USB Audio .....	<b>39</b>
Controlling MainStage (DAW CTRL Function) .....	<b>40</b>
◇ <b>Connecting External Devices</b> .....	<b>40</b>
Controlling an External MIDI Device .....	<b>40</b>
Using the AIRA LINK Function .....	<b>41</b>
Using I-ARPEGGIO Sync Mode .....	<b>41</b>
Controlling from an External Device .....	<b>41</b>

---

**Settings for the Entire Unit** ..... 42

- ◇ **Accessing the MENU Screen** ..... 42
  - Editing the Scene Settings (SCENE EDIT) ..... 42
  - Editing the I-ARPEGGIO Settings (ARPEGGIO EDIT) ..... 42
  - Editing the Tone Settings (TONE EDIT) ..... 42
  - Specifying the Key Range (KEY RANGE SETTINGS) ..... 43
  - Playing Only the MODEL BANK Tones (SINGLE SETUP) ..... 43
  - Editing the System Settings (System) ..... 43
  - Convenient Functions (UTILITY) ..... 43
  - Viewing the Software Version (INFORMATION) ..... 43

---

**Saving the Settings (WRITE MENU)** ..... 44

- ◇ **Accessing the WRITE MENU Screen** ..... 44
  - Saving Scenes and Tones at the Same Time (SCENE & TONE) .... 44
  - Saving a Scene (SCENE) ..... 44
  - Saving the Tone Settings of Each Part (PART1-4 TONE) ..... 44
  - Editing the System Settings (System) ..... 44

---

**Convenient Functions (UTILITY Screen)** ..... 45

- ◇ **Backing-Up Data to a USB Flash Drive** ..... 45
  - Formatting a USB Flash Drive (FORMAT USB MEMORY) ..... 45
  - Backing-Up Data to USB Flash Drive (BACKUP) ..... 45
  - Restoring Backup Data (RESTORE) ..... 45
- ◇ **Using the IMPORT/EXPORT Function** ..... 46
  - Importing Tones ..... 46
  - Importing Scenes ..... 46
  - Exporting Tones ..... 47
  - Exporting Scenes ..... 47
  - Exporting Step Edit Patterns ..... 48
- ◇ **Returning to the Factory Settings (FACTORY RESET)** ..... 48

---

**Sound Engine Routing Details** ..... 49

---

**Error Messages** ..... 50

---

**Q&A** ..... 51

---

**Main Specifications** ..... 56

---

# An Overview of the JUNO-X

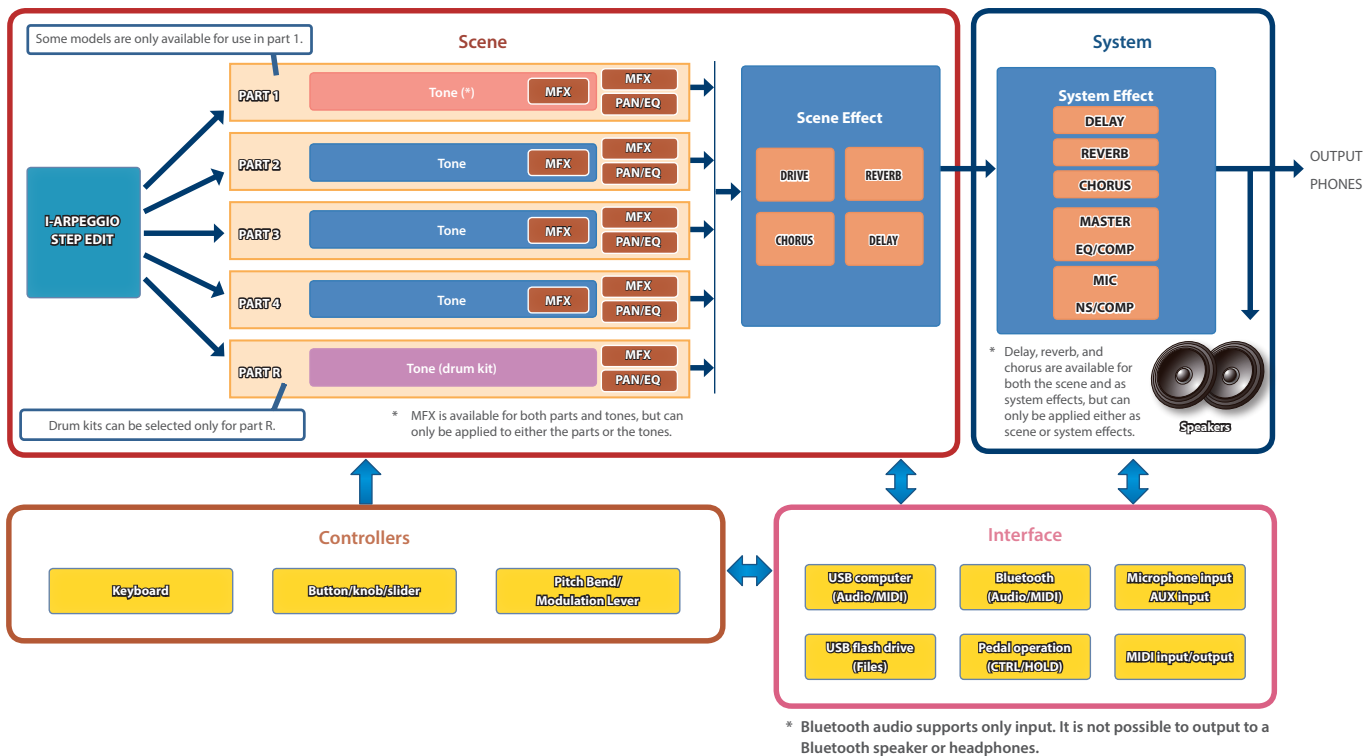

## \*Elements of a tone (expanded view)

• Model: JUNO-X, JUNO-106, JUNO-60

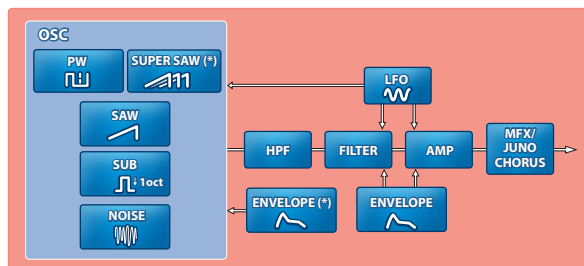

Elements marked with an asterisk (\*) are enabled only for the JUNO-X model.

\* Some functions may vary, depending on the model.

• Model: XV-5080, RD-PIANO, etc.

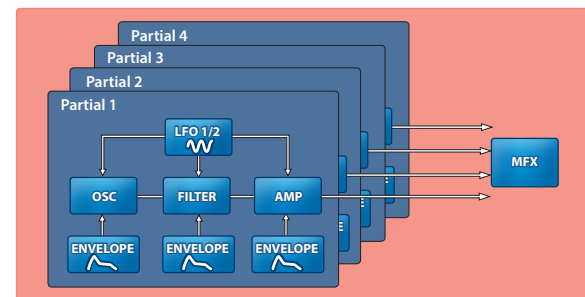

## Basic Structure

### Tone

The sounds that you play from the keyboard are called “tones.” A tone consists of an oscillator (OSC) that creates the basis of the sound, along with a filter, effects (MFX) and other components that modify the sound. The types of oscillator, filter, and effect differ depending on the model.

#### Model

A “model” is a sound engine such as that of the JUNO-106, JUNO-60 or XV-5080, which reproduces the sound of a specific vintage synthesizer, or which offers distinctive functionality.

The JUNO-X features numerous models. You can use a single JUNO-X as if you owned a variety of different synthesizers.

Each model has distinctive parameters, effects and other elements, and you can use these to create tones that are unique to those models.

#### Category

The classifications of instruments or types of sounds such as “Synth Bass” or “Ensemble Strs” are called “categories.”

### OSC (Oscillator)

This section generates an audio waveform according to the pitch information that is sent from the keyboard. The pitch is determined by how rapidly the waveform repeats (or in other words, its frequency). Faster repetition (higher frequency) means higher pitch, and slower repetition (lower frequency) means lower pitch.

### LFO (Low frequency oscillator)

Like the oscillator, the LFO section generates a waveform at a specified frequency.

The LFO waveform is applied to the OSC, FILTER and AMP signal to create various effects. For instance, you can apply an LFO to the OSC section, to cyclically raise and lower the pitch for a vibrato effect.

#### MEMO

The LFO waveform can be seen in the MODEL BANK TOP screen.



## FILTER

Oscillator waveforms are generated using a mixture of different harmonics.

The filter lets you modify the brightness of the sound by selectively reducing these harmonics or boosting them in the region of the cutoff frequency.

By applying an LFO to the FILTER section, you can cyclically raise or lower the cutoff frequency, producing a wah effect.

## AMP

The amp section controls the volume.

By applying an LFO to the AMP section, you can cyclically raise and lower the volume, producing a tremolo effect.

## ENV (Envelope)

Each time you press a key, a time-based change is applied to the OSC, FILTER, and AMP sections for each individual note.

This shape of this time-based change is called the “envelope.”

### MEMO

The envelope can be seen in the MODEL BANK TOP screen.

## Part

A “part” is a location to which you can recall a tone and save it together with settings such as pan and EQ.

Each scene has five parts: for parts 1–4 you can select a synthesizer tone, and for part R you can select a drum kit tone.

## Scene

Settings of all parts, scene effect settings, and I-Arpeggio settings can be stored together as a “scene.”

A scene lets you store the sequence data for each part, settings for each part (tone number, pan, volume, etc.), settings that are common to all parts (delay, reverb, chorus, etc.), and favorite performance data.

You can prepare several scenes in which you’ve stored your favorite settings, and then switch between your scenes to simultaneously change a number of settings.

The JUNO-X can store 256 scenes.

## I-ARPEGGIO

The I-Arpeggio function analyzes your keyboard playing and produces an optimal arpeggio pattern.

You can create a song using the following workflow:

“perform with I-Arpeggio” → “adjust the phrases you like with Step Edit” → “import the result into your computer’s DAW as MIDI data.”

## System

You can apply system effects to the audio signal from the scene, and output the resulting sound to an external device connected to the OUTPUT jacks or the PHONES jacks, as well as to the speakers that are built into the JUNO-X.

The system settings let you edit the system effects. Unlike the scene effects, these parameters keep their settings even when you switch scenes.

## Controllers

The controllers include the keyboard, the buttons/knobs/sliders on the panel, the pitch bend and modulation lever, the pedals connected to the rear panel and so on.

Performance data generated when you press or release a key or press the damper pedal is converted into MIDI messages and sent to each part or to an external MIDI device.

## Interface

This section lets you connect to an external MIDI device and transfer audio and MIDI data, as well as transfer audio and MIDI data to other devices connected via Bluetooth or USB.

If you connect a USB flash drive to the rear panel, you can use it to save or load scene and tone data.

# Panel Descriptions

## Top Panel

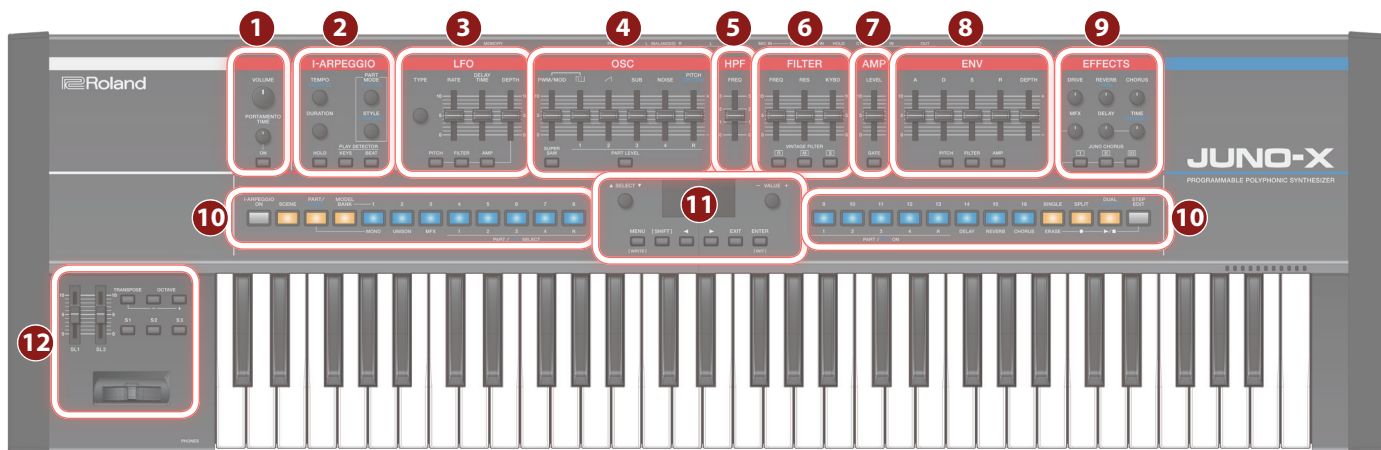

\* Some buttons, knobs or sliders may be disabled depending on the model you select.

### 1 [VOLUME] knob

Adjusts the overall volume.

### PORTAMENTO [TIME] knob

Changes the speed at which the pitch changes when portamento is on.

### PORTAMENTO [ON] button

Selects whether the portamento effect is applied to the notes that you play.

### 2 I-ARPEGGIO section

#### [TEMPO] (SHUFFLE) knob

You can specify the tempo of the arpeggio.

Also, you can press the [PART/FUNC] button to make it light up blue and then turn the [TEMPO] (SHUFFLE) knob to adjust the shuffle feel of the sound.

#### [DURATION] knob

You can specify the length during which each of the arpeggiated notes is heard. Shortening the duration produces a staccato feel, and lengthening the duration produces a tenuto feel.

Make the [PART/FUNC] button light up blue to edit the motif for the current part.

\* The [DURATION] knob changes the value for all parts at the same time.

#### PART [MODE] (P-STYLE) knob

Selects the arpeggio mode for parts 1–R. The mode you select changes how the arpeggio plays.

Also, you can press the [PART/FUNC] button to make it light up blue and then turn the PART [MODE] (P-STYLE) knob to set how the probability (\*) changes. Turn the knob all way counterclockwise to switch this off.

#### PART [STYLE] (P-AMOUNT) knob

Selects the arpeggio pattern for each part.

You can also press the [PART/FUNC] button to make it light up blue and then turn the PART [STYLE] (P-AMOUNT) knob to adjust how much probability (\*) is applied.

#### (\* What is “probability”?

The probability setting changes the randomness of the notes that sound when you are using the I-ARPEGGIO function, giving the notes a more human feel. By changing the P-STYLE settings, you can alter the timing at which notes are played with a more random feel; and by adjusting the P-AMOUNT setting, you can change how often the notes play.

### [HOLD] button

Turns the hold function of arpeggio on/off.

When the hold function is on, the sound of the last-played key is held.

### PLAY DETECTOR [KEYS] button

When this button is on (lit), the constituent notes of the arpeggio change according to the chords you play on the keyboard.

### PLAY DETECTOR [BEAT] button

When this button is on (lit), the arpeggio pattern changes according to the timing at which you play the keys.

### 3 LFO (low frequency oscillator) section

#### [TYPE] knob

Selects the LFO waveform.

#### [RATE] slider

Specifies the LFO's modulation speed.

#### [DELAY TIME] slider

Specifies the time from when the tone sounds until the LFO reaches its maximum amplitude.

#### [DEPTH] slider

This specifies the depth of the LFO.

#### [PITCH] button

When this button is on (lit), you can use the [DEPTH] slider to adjust the intensity of the vibrato.

#### [FILTER] button

When this button is on (lit), you can use the [DEPTH] slider to adjust the intensity of the wah effect.

#### [AMP] button

When this button is on (lit), you can use the [DEPTH] slider to adjust the intensity of the tremolo effect.

#### 4 OSC (oscillator) section

##### [PWM/MOD] slider

Changes the waveform modulation, such as the duty cycle of the square wave.

##### [□] slider

Adjusts the level of the square wave or asymmetrical square wave.

##### [∕] slider

Adjusts the level of the sawtooth wave.

##### [SUB] slider

Adjusts the level of the sub oscillator.

##### [NOISE] slider

Adjusts the level of the noise.

##### [PITCH] (DETUNE) slider

Adjusts the pitch of the oscillator.

Also, you can press the [PART/FUNC] button to make it light up blue and then use the [PITCH] (DETUNE) slider to detune the pitches of the two oscillators.

##### [SUPER SAW] button

\* This button is enabled only when "JUNO-X" is selected for the model. When this button is on (lit), use the [PWM/MOD] slider to adjust how much the sawtooth wave is overlapped, and use the [□] slider to adjust the level.

##### [PART LEVEL] button

When this button is on (lit), you can use the corresponding sliders to adjust the volume of parts 1–R.

#### 5 HPF (high-pass filter) section

##### [FREQ] slider

Specifies the cutoff frequency of the high-pass filter. The frequency components below the cutoff frequency are cut off.

#### 6 FILTER section

##### [FREQ] slider

Adjusts the cutoff frequency of the filter.

##### [RES] slider

Emphasizes the frequencies around the filter's cutoff frequency. Larger values produce greater emphasis, creating a unique synthesizer-like sound.

##### [KYBD] slider

Varies the filter's cutoff frequency according to the position of the key.

Raising the slider increases the value, and the cutoff increases with higher notes. Lowering the slider decreases the value, and the cutoff decreases with lower notes.

##### VINTAGE FILTER [R] [M] [S] buttons

If a vintage type model is selected, these buttons change the type of filter.

[R] models a Roland filter, and [M] and [S] model the filters of vintage synthesizers made by other manufacturers.

#### 7 AMP section

##### [LEVEL] knob

Adjusts the volume.

##### [GATE] button

When this button is on (lit), the notes play at a specific volume only while you press the keys.

#### 8 ENV (envelope) section

##### [A] [D] [S] [R] sliders

These sliders control the envelope, which creates time-based changes to the sound.

**A:** Attack time (the time it takes for the sound to rise)

**D:** Decay time (the time it takes for the sound to attenuate)

**S:** Sustain level (the level at which the sound sustains)

**R:** Release time (the length of time that the sound lingers)

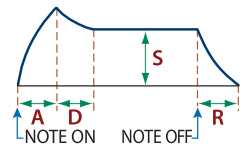

##### [DEPTH] slider

Used in conjunction with the [PITCH] button and [FILTER] button, this slider specifies the depth of each envelope. No effect is applied when the value shown onscreen is zero.

##### [PITCH] button

If this button is on (lit), use the [DEPTH] slider and [A] [D] [S] [R] sliders to edit the pitch envelope.

##### [FILTER] button

If this button is on (lit), use the [DEPTH] slider and [A] [D] [S] [R] sliders to edit the FILTER envelope.

##### [AMP] button

If this button is on (lit), use the [A] [D] [S] [R] sliders to edit the AMP envelope.

#### 9 EFFECTS section

##### [DRIVE] knob

Adjusts how much distortion is applied to the sound (applies to all parts, but enabled only for parts whose Part:Output is set to "DRIVE").

##### [REVERB] (TIME) knob

Adjusts the depth of reverb (individually for each part).

Also, you can press the [PART/FUNC] button to make it light up blue and then operate the [REVERB] (TIME) knob to set the reverb length.

##### [CHORUS] knob

Adjusts the amount of chorus (individually for each part).

##### [MFX] knob

Adjusts the MFX depth (individually for each part).

##### [DELAY] knob

Adjusts the amount of delay (individually for each part).

##### [TIME] (FEEDBACK) knob

Adjusts the delay time (for all parts together).

Also, you can press the [PART/FUNC] button to make it light up blue and then operate the [TIME] (FEEDBACK) knob to adjust the amount of delay feedback.

##### JUNO CHORUS [I] [II] [III] buttons

Selects the chorus type.

\* More than one button can be selected at the same time.

**10 Performance section**

**[I-ARPEGGIO ON] button**

Turns the arpeggio function on/off.

**[SCENE] button**

Switches to scene select mode. In scene select mode, press buttons [1]–[16] to select a scene. You can also hold down the [SCENE] button and press buttons [1]–[16] to select a scene bank.

**[PART/FUNC] button**

Switches to part select mode. When you press this button again to make it light up blue, the instrument switches to FUNC mode, and the functions on the controls that are lit up blue are enabled.

**[MODEL BANK] button**

Switches to tone select mode. In tone select mode, press buttons [1]–[16] to select the tones from each model/category.

**[1]–[16] buttons**

These buttons have various functions depending on the mode.

**Scene select mode ([SCENE] button)**

The buttons switch scenes.

**Part select mode ([PART/FUNC] button)**

In this mode, you can switch the current part (buttons [4]–[8]) and turn parts on/off ([9]–[13]). MONO mode ([1]), the unison function ([2]) and effects ([3], [14]–[16]).

When the [PART/FUNC] button is lit blue, you can use the buttons to switch the current oscillator ([4]–[7]) and turn the oscillators on/off ([9]–[12]).

\* Use buttons [9]–[13] to turn the parts (SCENE ZONE EDIT > Keyboard Sw) on/off that can be played from the keyboard. If you want to turn on/off the sound of individual parts when playing an arpeggio, hold down the [SHIFT] button and press a [9]–[13] button (PART SW ON/OFF).

**Tone select mode ([MODEL BANK] button)**

Use this mode to select the tones of the models/categories that are assigned to the buttons. Hold down the [MODEL BANK] button and press buttons [1]–[16] to specify the assigned model or category.

**Step edit mode ([STEP EDIT] button)**

Use this mode to edit the I-ARPEGGIO step edit data.  
 → “Using the Step Edit Function” (p. 20)

**[SINGLE] button**

Press this to play only one tone at a time (no layers). In arpeggio step edit mode, use this button to erase steps that you’ve edited.

**[SPLIT] button**

When this button is on (lit), the keyboard is divided into two regions that you can play separately. To set the split point (the place on the keyboard where the regions are divided), hold down the [SPLIT] button and press the desired key.

In arpeggio step edit mode, use this button to record notes in a step.

**[DUAL] (L/R DUAL) button**

When this button is on (lit), you can play two tones layered together. Also, when you press this button while the [PART/FUNC] button is lit blue, the tone for part 1 sounds from the left side and the tone for part 2 sounds from the right side, making the sound more spacious (L/R DUAL). In arpeggio step edit mode, press this button to play or stop the step you edited.

**[STEP EDIT] button**

Switches to arpeggio step edit mode. The buttons edit each step of the arpeggio performance.

**11 Common section**

**[▲SELECT▼] knob**

Moves the cursor position up/down. In scene select mode, use this knob to select a scene bank. In tone select mode, use this knob to select a model/category.

**Display**

Shows various information for the operation.

**[- VALUE +] knob**

Use this knob to move the cursor or change a value. In scene select mode, use this knob to select a scene. In tone select mode, use this knob to select a tone.

**[MENU] (WRITE) button**

Pressing this button makes the MENU screen appear. Use this button to jump to a specific edit screen, or to switch to the system or utility screens. Also, you can press the [MENU] (WRITE) button while holding down the [SHIFT] button to jump to the screens for saving scene settings, system settings and so on.

**[SHIFT] button**

Press the [MENU] (WRITE) button while holding down this button to jump to the screens for saving scene settings, system settings and so on. You can also hold down this button and press the [ENTER] (INIT) button to jump to the screen for initializing the scene or tone you are setting.

\* By holding down the [SHIFT] button and operating a button, knob or slider, you can jump to the settings screen for that parameter.

**[◀] [▶] buttons**

Use these buttons to switch between screen pages. This takes you to the edit pages that are arranged from left to right for the SCENE TOP screen or the MODEL BANK TOP screen.

**[EXIT] button**

Returns you to the previous screen. In some screens, this cancels the function currently being executed. \* By holding down the [EXIT] button and operating a knob or other controller, you can check its current value. This lets you check a value without modifying the sound.

**[ENTER] (INIT) button**

Press this to confirm a value or execute an operation. You can also press the [ENTER] (INIT) button while holding down the [SHIFT] button to jump to the screen for initializing the scene or tone you are setting. Press this button while in scene select mode or tone select mode to view the list of scenes or tones.

**12 Controller section**

**[SL1] [SL2] sliders**

These sliders control the parameters that are assigned to the sliders.

**[TRANPOSE] button**

By holding down this button and using the OCTAVE [-] [+] buttons you can transpose the pitch of the keyboard in semitone units.

**OCTAVE [-] [+] buttons**.....

Shift the pitch of the keyboard in units of one octave.

**[S1] [S2] [S3] buttons**.....

These buttons control the parameters that are assigned to the buttons.

**Pitch Bend/Modulation Lever**.....

This allows you to control pitch bend or apply vibrato.

## Rear Panel (Connecting Your Equipment)

\* To prevent malfunction and equipment failure, always turn down the volume, and turn off all the units before making any connections.

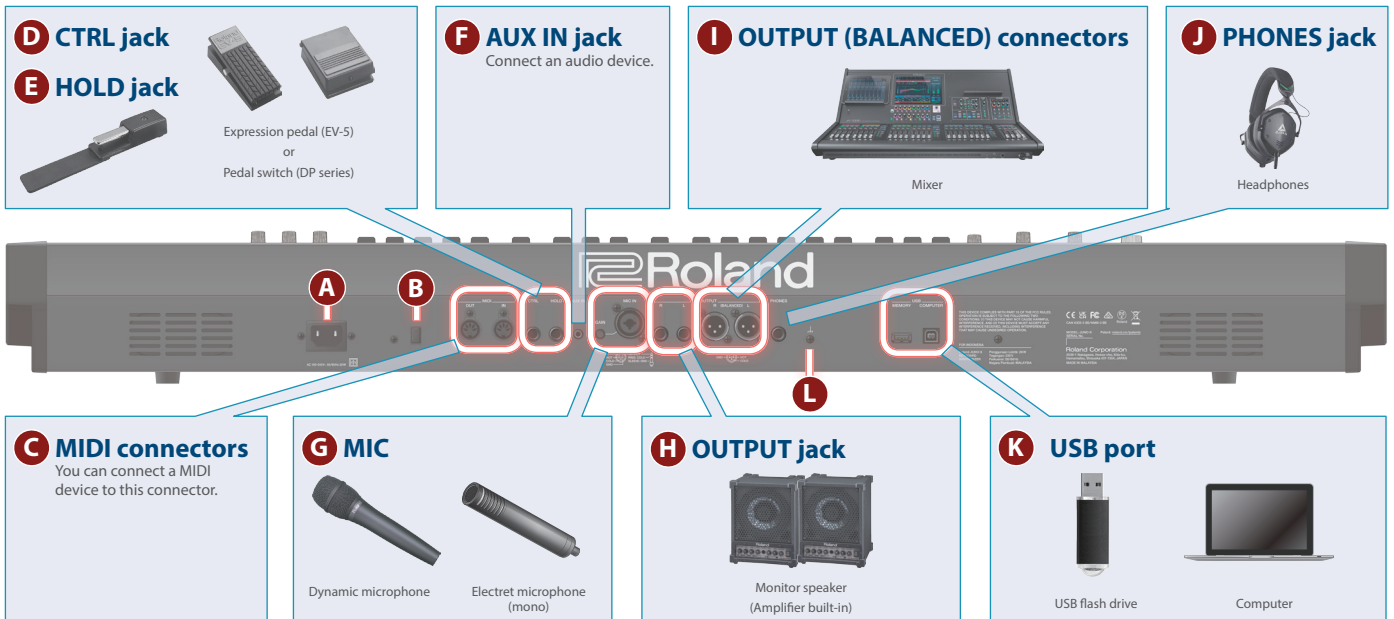

**A AC IN jack**

Connect the included power cord.

**B [ON] switch**

This switches the power on and off (p. 11).

**C MIDI (OUT/IN) connectors**

These connectors transmit and receive MIDI messages to/from connected external MIDI devices.

**D CTRL jack**

Connect an expression pedal (EV-5; sold separately).

\* Use only the specified expression pedal. By connecting any other expression pedals, you risk causing malfunction and/or damage to the unit.

**E HOLD jack**

Connect a pedal switch (DP series; sold separately).

**F AUX IN jack**

Connect an external audio device.  
Use a stereo mini plug for this connection.

**G MIC**

**MIC IN [GAIN] knob**

Adjusts the volume of the mic input.

**MIC IN jack**

Connect a dynamic microphone or electret condenser microphone (plug-in power system) here.

\* A condenser microphone (phantom powered) cannot be used.

Pin assignment of MIC IN jack



**H OUTPUT L/R jacks**

These are output jacks for audio signals.  
Connect your amplified speakers etc.

**I OUTPUT (BALANCED) L/R connectors**

These are output connectors for audio signals.  
Connect these to your mixer etc.

Pin assignment of OUTPUT (BALANCED) L/R connectors

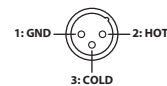

**J PHONES jack**

Connect stereo 1/4-inch phone type headphones here.

**K USB port**

**USB MEMORY port**

Connect a USB flash drive.

\* Connect or disconnect the USB flash drive while the JUNO-X is powered-off.

\* Never turn off the power or disconnect the USB flash drive during a process, such as while the "Executing..." display is shown.

**USB COMPUTER port**

Use a USB cable to connect this port to a USB port of your computer.

This allows the JUNO-X to operate as a USB MIDI device.

**L Ground terminal**

Connect this to an external earth or ground if necessary.

## Front Panel (Connecting Your Equipment)



**M PHONES jack**

Connect stereo mini-type headphones here.



# Getting Ready to Play

## Placing the JUNO-X on a Stand

If you want to place the JUNO-X on a stand, use the Roland KS-10Z or KS-12. Place the JUNO-X on the stand as follows.

Be sure to follow the instructions in the Owner's Manual carefully when placing this unit on a stand. If it is not set up properly, you risk creating an unstable situation which could lead to the unit falling or the stand toppling, and may result in injury.

\* Be careful not to pinch your fingers when setting up the stand.

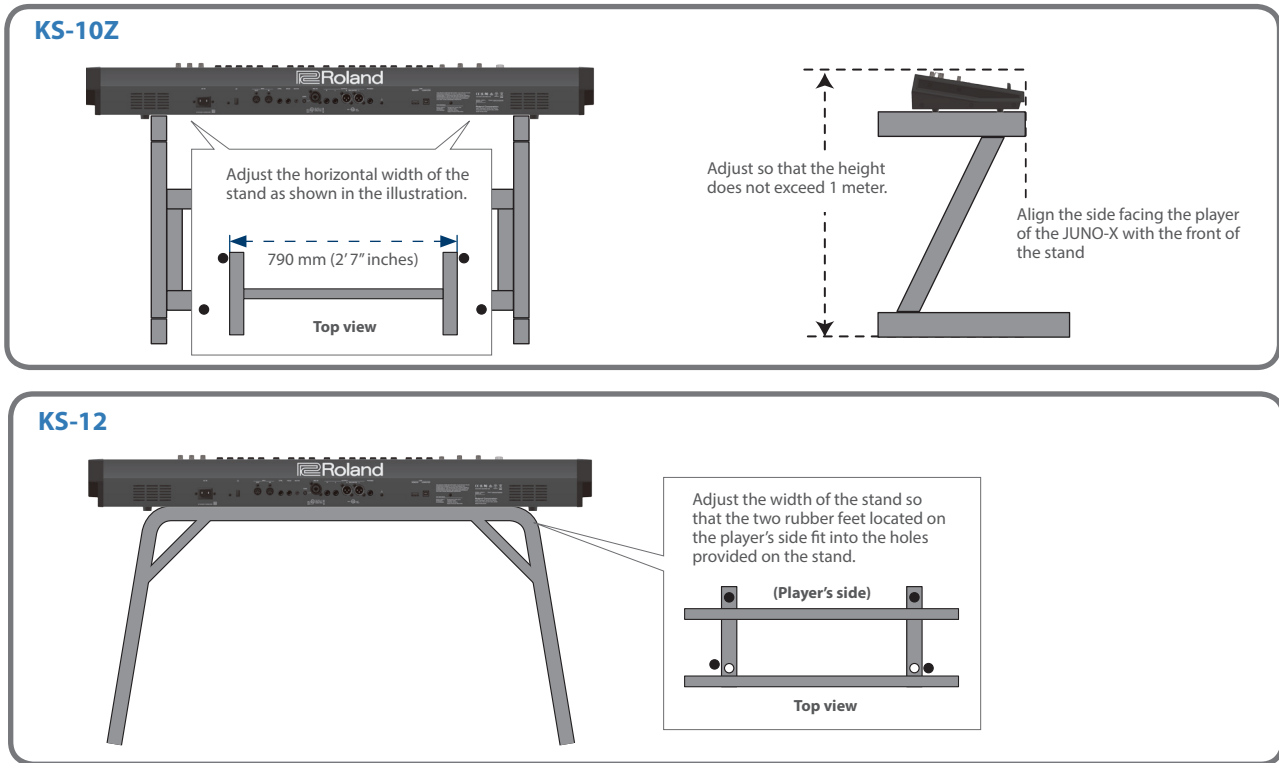

## Turning the Power on and Adjusting the Volume

### 1. Turn the volume of the JUNO-X all the way down.

If you've connected external speakers or similar audio equipment to this instrument, turn the volume of those external devices all the way down as well.

### 2. Power-on the equipment in the order of JUNO-X → connected devices.

\* In order to protect its circuitry, the JUNO-X waits for a while after being powered on before it begins operating.

### 3. Raise the volume of the connected equipment to an appropriate level.

### 4. Adjust the volume of the JUNO-X with the [VOLUME] knob.

## Turning the Power off

### 1. Turn the volume of the JUNO-X all the way down.

If you've connected external speakers or similar audio equipment to this instrument, turn the volume of those external devices all the way down as well.

### 2. Turn off the equipment in this order: connected devices → JUNO-X.

\* If you need to turn off the power completely, first turn off the unit, then unplug the power cord from the power outlet. Refer to "To completely turn off power to the unit, pull out the plug from the outlet" in the "Quick Start."

## Setting the AUTO OFF function

The power to this unit will be turned off automatically after a predetermined amount of time has passed since it was last used for playing music, or its buttons or controls were operated (Auto Off function). If you do not want the power to be turned off automatically, disengage the Auto Off function.

\* Unsaved settings are lost when you turn the power off. Before turning the power off, save (WRITE) the data that you want to keep (p. 44).

\* To restore power, turn the power on again.

### 1. Press the [MENU] (WRITE) button.

### 2. Use the [▲SELECT▼] knob to select "SYSTEM," and then press the [ENTER] (INIT) button.

### 3. Use the [▲SELECT▼] knob to select "Auto Off" and use the [-VALUE+] knob to change the setting.

If you don't want the unit to turn off automatically, choose the "OFF" setting.

Parameter [▲SELECT▼] knob	Value [-VALUE+] knob
Auto Off	OFF, 30 (min), 240 (min)

### 4. To save the edited settings, hold down the [SHIFT] button and press the [MENU] (WRITE) button.

A confirmation message appears.

If you decide to cancel, press the [EXIT] button.

### 5. To execute, press the [ENTER] (INIT) button.

## Using the Built-In Speakers

This unit contains built-in stereo speakers. If the built-in speakers are turned on, you can play sound from this unit.

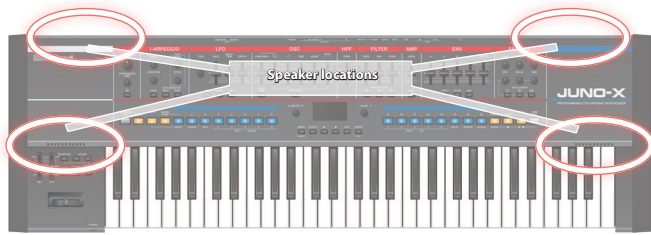

1. Press the [MENU] (WRITE) button.
2. Use the [▲SELECT▼] knob to select "SYSTEM," and then press the [ENTER] (INIT) button.
3. Use the [▲SELECT▼] knob to select "Speaker Sw," and use the [- VALUE +] knob to specify "ON" or "AUTO."

Parameter [▲SELECT▼] knob	Value [- VALUE +] knob	Explanation
Speaker Sw	OFF	Sound is not output from the speakers.
	ON	Sound is output from the speakers.
	AUTO	When headphones are connected, the sound is output through the headphones; and when headphones are not connected, the sound is output through the speakers.

4. To save the settings, hold down the [SHIFT] button and press the [MENU] (WRITE) button.  
A confirmation message appears.  
If you decide to cancel, press the [EXIT] button.
5. To execute, press the [ENTER] (INIT) button.



# Selecting a Sound

## Selecting a Scene (Scene Select Mode)

On the JUNO-X, you select a scene and play by assigning a tone to each of the five parts. In scene select mode, you can switch scenes and view the selected state of the parts and partials.

### SCENE TOP screen

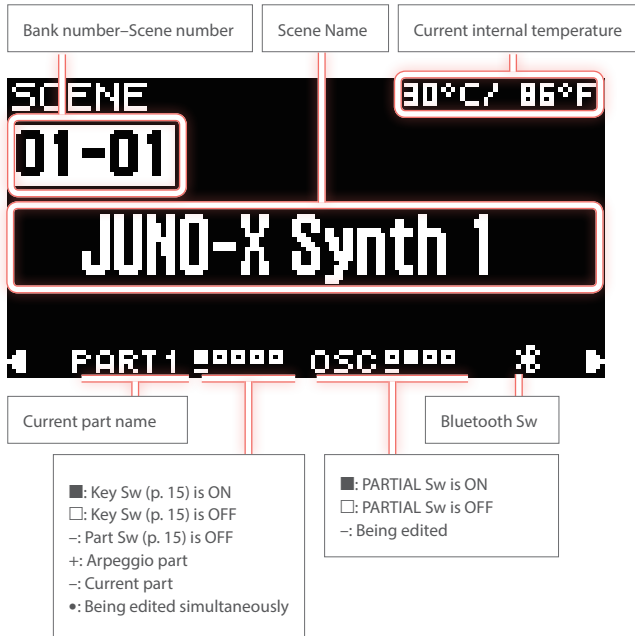

### 1. Press the [SCENE] button.

The SCENE TOP screen appears, and the instrument switches to scene select mode.

\* The SCENE TOP screen is the first screen that appears when you turn on the power.

### 2. Press the [1]–[16] buttons or use the [- VALUE +] knob to select a scene.

#### MEMO

The system parameter “Startup Scene” lets you specify the scene that is selected at start-up.

→ “Parameter Guide” (PDF)

## Selecting a Scene from a List

### 1. Press the [SCENE] button.

### 2. Press the [ENTER] (INIT) button.

The scene list appears.

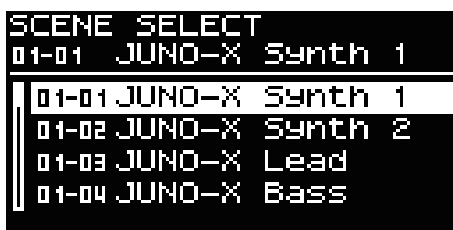

### 3. Use the [- VALUE +] knob to select a scene.

You can use the [▲SELECT▼] knob to jump to the previous or next scene bank.

### 4. Press the [ENTER] (INIT) button to confirm the scene.

## Switching Between Scene Banks and Selecting Scenes

### 1. Press the [SCENE] button.

### 2. Use the [▲SELECT▼] knob to select a scene bank.

#### MEMO

You can also hold down the [SCENE] button and press buttons [1]–[16] to select a scene bank.

### 3. Press the [1]–[16] buttons or use the [- VALUE +] knob to select a scene.

\* To recall a different scene bank than the one that's currently selected, select the scene bank and then select the scene to switch to.

## Selecting a Tone (Tone Select Mode)

The JUNO-X is equipped with multiple sound engines called “models,” and each model has a diverse variety of sounds (tones). You can use the category function with the tones, to narrow down to specific types of instruments or sounds across all of the sound engines.

In tone select mode, you can select tones and view the selected state of the parts and partials.

### MODEL BANK TOP screen

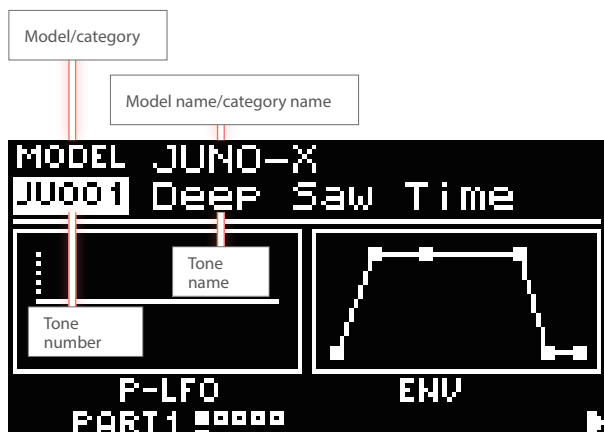

1. Press the [MODEL BANK] button.

The MODEL BANK TOP screen appears, and the instrument switches to tone select mode.

2. Use the [▲SELECT▼] knob to move the cursor to the model/category name.

3. Use the [- VALUE +] knob to select the model/category.

4. Use the [▲SELECT▼] knob to move the cursor to the tone number.

5. Use the [- VALUE +] knob to select a tone.

Select the desired tone from the selected model and category.

### Selecting a Tone from a List

1. Press the [MODEL BANK] button.

2. Press the [ENTER] (INIT) button.

The tone list appears.

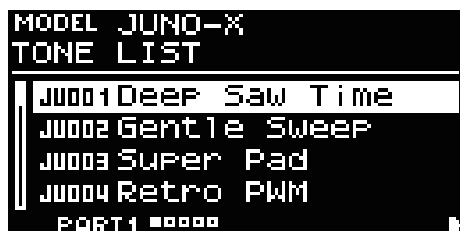

3. Use the [- VALUE +] knob to select a tone.

4. Press the [ENTER] (INIT) button to confirm the tone.

## Registering to a Model Bank and Selecting a Tone

By using the model bank function, you can instantly recall your favorite models or categories.

With the factory settings, a specific model or category is registered to each of the [1]–[16] buttons.

You can assign the desired model or category to each button.

### Registering to a model bank

1. Hold down the [MODEL BANK] button and press the button ([1]–[16]) of the model bank that you want to assign.

2. Use the [▲SELECT▼] knob to move the cursor to “Attr.”

3. Use the [- VALUE +] knob to select the model/category/user.

4. Use the [▲SELECT▼] knob to select the model number you want to change.

5. Use the [- VALUE +] knob to select a model name (device name) or category name.

\* You can register up to eight models or categories in one model bank.

\* You can’t mix and assign both a model and a category in a single model bank.

6. If you want to save the setting, execute the System Write operation.

- 6-1. Hold down the [SHIFT] button and press the [MENU] (WRITE) button.

The WRITE MENU screen appears.

- 6-2. Use the [▲SELECT▼] knob to select “SYSTEM,” and then press the [ENTER] (INIT) button.

- 6-3. To execute, press the [ENTER] (INIT) button.

### Recalling a tone from a registered model bank

1. Press the [MODEL BANK] button.

The MODEL BANK TOP screen appears, and the [1]–[16] buttons switch to tone select mode.

2. Press the [1]–[16] buttons to select a model bank.

3. Press the [ENTER] (INIT) button.

The tone list appears.

4. Use the [- VALUE +] knob to select a tone.

5. Press the [ENTER] (INIT) button.

## Selecting a Part (Part Select Mode)

On the JUNO-X, the part you're editing and the part that you're playing from the keyboard can be selected separately. In part select mode, you can assign desired functions to the [4]–[13] buttons.

### MEMO

You can select a synthesizer tone for each part 1–4, and a drum kit tone for part R. You can select one tone for each part.

## Showing the Part Setting Status List

This feature is useful when you want to always see the list of parts when you play.

1. On the SCENE TOP screen, press the [PART/FUNC] button while holding down the [SCENE] button.

This shows the part setting status list.



You can make the following settings on this screen.

### Current part selection

Use the PART/OSC SELECT [1]–[R] buttons to select.

- \* For the part that's set as the current part, you can use the panel knobs to edit the tone.

### On/off for each part

Use the PART/OSC ON [1]–[R] buttons to switch each part on/off.

### Tone switches for each part

Use the [▲SELECT▼] knob to move the cursor to the part to switch, and use the [- VALUE +] knob to set the tone.

### Switching between scenes

Use the [▲SELECT▼] knob to move the cursor to the scene you want to switch to, and use the [- VALUE +] knob to set.

2. To return to the SCENE TOP screen, press the [PART/FUNC] button while holding down the [SCENE] button.

## Selecting the Part to Edit (Current Part)

Here's how to use the panel buttons and knobs to select the part you want to edit.

1. Press the [PART/FUNC] button.  
The instrument enters part select mode.
2. Use the PART/OSC SELECT [1]–[R] buttons ([4]–[8] buttons) to select the current part.  
The current part button lights up.

### MEMO

When editing a tone, you can press two or more of the PART/OSC SELECT [1]–[R] buttons simultaneously to edit multiple parts at the same time as the current part.

→ "Editing a Tone (TONE EDIT)" (p. 25)

## Selecting the Parts to Perform

Here's how to select the parts that you'll perform from the keyboard.

1. Press the [PART/FUNC] button.  
The instrument enters part select mode.
2. Use the PART/OSC ON [1]–[R] buttons ([9]–[13] buttons) to switch each performance part on/off.

Parts that are on are shown with a "K."

When the PART/OSC ON [1]–[R] buttons are lit, the SCENE ZONE EDIT "KeySw" setting of the corresponding parts turns "ON," letting you play them from the keyboard.

## Assigning Functions to the [4]–[13] Buttons

In part select mode, you can assign desired functions to the [4]–[13] buttons.

1. Press the [MENU] (WRITE) button.
2. Use the [▲SELECT▼] knob to select "SYSTEM," and then press the [ENTER] (INIT) button.
3. Use the [▲SELECT▼] knob to select the "PART Btn Asgn" item, and use the [- VALUE +] knob to change the value.

You can assign the functions that occur when you press the [4]–[8] buttons or the [9]–[13] buttons, and the functions that occur when you hold down the [SHIFT] button and press the [4]–[8] buttons or the [9]–[13] buttons.

Parameter [▲SELECT▼] knob	Value [- VALUE +] knob	Explanation
4-8, 4-8+(S), 9-13, 9-13+(S)	No Assign	Nothing is assigned.
	PartSel	Select the current part.
	Part+KeySw	Simultaneously turn on/off the parts that play and turn on/off the performance parts.
	KeySw	Turn on/off the performance parts.
	PartSw	Turn on/off the parts that play.
	ArpSw	Turn on/off arpeggio performance.
EfxSw	Turn on/off effects.	

- \* The "+(S)" following the parameter name means "while pressing the [SHIFT] button."

4. To save the settings, hold down the [SHIFT] button and press the [MENU] (WRITE) button.  
A confirmation message appears.  
If you decide to cancel, press the [EXIT] button.
5. To execute, press the [ENTER] (INIT) button.

# Playing

When you play the keyboard, you hear the sound of the part(s) that you selected in “Selecting the Parts to Perform” (p. 15). The JUNO-X lets you customize performance-related settings so that you can perform in the way that’s best for you.

## Performing Arpeggios

To start arpeggio performance, make the I-ARPEGGIO [ON] button lit.

→ “I-ARPEGGIO” (p. 18)

## Layering Tones and Splitting the Keyboard

### SINGLE

Press the [SINGLE] button when you want to play this instrument using only one tone without layering.

\* Note that once you press the [SINGLE] button, the scene data you were editing is lost. If you want to keep the data, save the scene before switching to SINGLE mode.

\* The SINGLE setting state is canceled when you switch scenes.

### SPLIT

When the [SPLIT] button is on (lit), the keyboard is divided into two regions that you can play separately. To set the split point (the place on the keyboard where the regions are divided), hold down the [SPLIT] button and press the desired key.

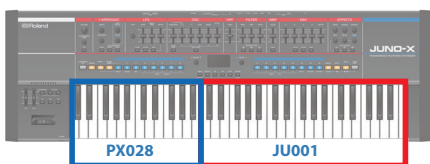

### DUAL

When the [DUAL] button is on (lit), you can play two tones layered together.

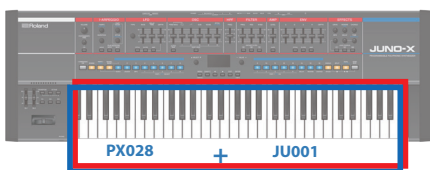

## Specifying the Key Range

By specifying the key range, a sound that you play or an arpeggio performance can be restricted to a specific region of keys.

For example, you could specify that the left-hand region of the keyboard plays only the bass part, so that an arpeggiated bass continues without being affected by what you play in the right-hand region of the keyboard. Alternatively, you could specify fades between multiple parts to create gradations between sounds.

1. Press the [MENU] (WRITE) button.
2. Use the [▲SELECT▼] knob to select “KEY RANGE SETTINGS,” and then press the [ENTER] (INIT) button.
3. Use the [▲SELECT▼] knob to select the parameter and use the [-VALUE+] knob to change the value.

Parameter [▼SELECT▲] knob	Value [-VALUE+] knob	Explanation
<b>SCENE ZONE</b>		
Key Rng Low	C- -G9	Set the keyboard range in which each part will sound. Make these settings when you want different key ranges to play different tones. Specify the lower limit of the key range.
Key Fade Low	0-127	Specifies the degree to which the part is sounded by notes played below the Key Rng Low. If you don't want the tone to sound at all, set this parameter to "0."
Key Rng Upp	C- -G9	Set the keyboard range in which each part will sound. Make these settings when you want different key ranges to play different tones. Specify the upper limit of the key range.
Key Fade Upp	0-127	Specifies the degree to which the part is sounded by notes played above the Key Rng Upp. If you don't want the tone to sound at all, set this parameter to "0."
<b>ARP PART</b>		
K-Range Lo	C- -G9	Specifies the lower pitch limit that is sounded by the arpeggio. If the arpeggiator attempts to play a note that is lower than this, the octave is raised.
K-Range Oct	0-12	Specifies the number of higher octaves in which the arpeggio is sounded, relative to K-Range Lo. If the arpeggiator attempts to play a note that is higher than this, the octave is lowered.
Oct Range	-3-+3	Specifies the range of octaves over which the arpeggio plays. You can specify whether the arpeggio is sounded in the octave(s) above (+) or below (-) the notes you play.
Transpose	-36-+36	Shifts the arpeggio notes in semitone steps.
<b>ARP COMMON</b>		
In Range Low	C- -G9	Specifies the range that is detected for arpeggio performance. Pressing a key outside the specified range does not affect the arpeggio function.
In Range Upp	C- -G9	

4. To save the settings, press the [SCENE] button and then press the [MENU] (WRITE) button while holding down the [SHIFT] button.

The WRITE MENU screen appears.

5. Use the [▲SELECT▼] knob to select “SCENE,” and then press the [ENTER] (INIT) button.
6. Use the [-VALUE+] knob to select the save-destination, and then press the [ENTER] (INIT) button.

To rename the scene that’s being saved, use the [◀] [▶] buttons to move the cursor and use the [-VALUE+] knob to select the characters.

7. Press the [ENTER] (INIT) button.  
A confirmation message appears.  
If you decide to cancel, press the [EXIT] button.
8. To execute, press the [ENTER] (INIT) button.

## Using the Controllers

You can use the controllers of the controller section to quickly operate the sound parameters or to modify the sound to create excitement in your performance.

To assign functions to controller, make settings in the system parameters.

→ “Parameter Guide” (PDF)

You can also assign functions to a footswitch or expression pedal, and use it to switch scenes or turn the arpeggio on/off while you perform.

→ “Controlling from an External Device” (p. 41)

## Performing with a Connected Mic (Vocoder)

The “Vocoder” adds effects to a human voice. If you run your voice through the vocoder, you can give it a toneless, robotic tone. Control the pitch by playing the keyboard.

\* For all other model banks besides VOCODER, the mic sound is output from the JUNO-X. When not using the mic for all other model banks besides VOCODER, set “Mic Thru” to “OFF”

\* VOCODER models can be selected only for part 1.

### 1. Connect a microphone to the rear panel MIC IN jack.

#### NOTE

The JUNO-X supports dynamic microphones and electret condenser microphone (plug-in power system). It does not support condenser microphones.

### 2. Use the rear panel MIC IN [GAIN] knob to adjust the volume.

Make detailed adjustments to the MIC IN volume after you select the sound.

Initially, set the knob to approximately the center position.

### 3. Select part 1, and then press the [MODEL BANK] button to make it light.

### 4. Press the [MODEL BANK] button and then press button [6].

\* With the factory settings, “VOCODER” is assigned to the model bank of the [6] button.

You can change the model bank that is assigned.

→ “Registering to a model bank” (p. 14)

### 5. Use the [- VALUE +] knob to select a vocoder sound (two types).

### 6. While playing the keyboard, vocalize into the microphone.

Use the MIC IN [GAIN] knob to make fine adjustments to the volume.

## Adjusting the Mic

Depending on the environment in which you’re performing, noise from the surroundings might be picked up by the mic, causing the vocoder to not work as you intend.

In this case, adjust the microphone sensitivity and the noise suppressor (NS) settings, so that it is less likely to pickup noise.

### 1. Press the [MENU] (WRITE) button.

### 2. Use the [▲SELECT▼] knob to select “SYSTEM,” and then press the [ENTER] (INIT) button.

### 3. Use the [▲SELECT▼] knob to select the MIC IN parameter that you want to edit, and use the [- VALUE +] knob to change the value.

## MIC IN parameters

Parameter [▼SELECT▲] knob	Value [-VALUE+] knob	Explanation
Mic In Gain	-24.0~+24.0 [dB]	Adjusts the input level of the MIC IN jack.
Mic Power	OFF, ON	If this is “ON,” plug-in power (5 V) is supplied to the MIC IN jack.
NS Switch	OFF, ON	Switches the noise suppressor on/off. The noise suppressor is a function that suppresses noise during periods of silence.
NS Threshold	-96~0 [dB]	Adjusts the volume at which noise suppression starts to be applied.
NS Release	0~127	Adjusts the time from when noise suppression starts until the volume reaches 0.
CompSwitch	OFF, ON	Specifies whether the mic compressor (a compressor applied to the mic input) is used (ON) or not used (OFF).
CompAttack	0.1, 1, 2, ...100 [ms]	Specifies the time from when the input to the mic compressor exceeds the CompThreshold level until the volume is compressed.
CompRelease	10, 20, ...1000 [ms]	Specifies the time from when the input to the mic compressor falls below the CompThreshold level until compression is no longer applied.
CompThreshold	-60~0 [dB]	Specifies the level at which the mic compressor starts applying compression.
CompRatio	1:1, 2:1, 3:1, 4:1, 8:1, 16:1, 32:1, INF:1	Specifies the compression ratio for the mic compressor.
CompKnee	0~30 [dB]	Smooths the transition until the mic compressor starts to be applied. Higher values produce a smoother transition.
CompOutGain	-24.0, -23.5, ...0, ...+24.0 [dB]	Specifies the output volume of the mic compressor.
Dly Send Lev	0~127	Specifies the amount of delay that is applied to the mic input.
Rev Send Lev	0~127	Specifies the amount of reverb that is applied to the mic input.
Cho Send Lev	0~127	Specifies the amount of chorus that is applied to the mic input.
Mic Thru	OFF, ON	If you want the mic to be cut when the vocoder is off, turn this “OFF.”

### 4. To save the settings, hold down the [SHIFT] button and press the [MENU] (WRITE) button.

A confirmation message appears.

If you decide to cancel, press the [EXIT] button.

### 5. To execute, press the [ENTER] (INIT) button.

## Preventing acoustic feedback

Acoustic feedback could be produced depending on the location of microphones relative to built-in speakers (or the external speakers). This can be remedied by:

- Changing the orientation of the microphone(s).
- Relocating microphone(s) at a greater distance from speakers.
- Lowering volume levels.

## Performing with a Connected Computer or Other External Device

You can connect a computer and use a plug-in synth in combination with this unit, or use it together with a product that is compatible with AIRA-LINK and enjoy synchronized performances.

→ “Control” (p. 39)

# I-ARPEGGIO

## Basic Methods of Operation

The I-Arpeggio function analyzes your keyboard playing and produces an optimal arpeggio pattern. You can select "I-ARP" to perform extemporaneously, or use the step edit function to create user patterns.

1. **Select the part to use for playing arpeggios by pressing the [PART/FUNC] button and then using the PART/OSC SELECT [1]–[4] buttons.**
2. **Press the I-ARPEGGIO [ON] button to enable arpeggio performance.**
3. **Use the PART [MODE] (P-STYLE) knob to select "I-ARP."**

\* You can set the arpeggio mode separately for each part.

MODE	How the arpeggio works
I-ARP	Analyzes your keyboard performance and plays the arpeggio pattern that best matches it.
ARP	Plays a simple arpeggio pattern.
STEP	Plays the pattern data you created using the STEP EDIT function (p. 20). Use this setting when you want to play original arpeggio phrases.
OFF	Use this setting if you don't want the arpeggio to sound for the currently selected part.

4. **Play the keyboard to generate an arpeggio.**

The I-ARPEGGIO plays for the currently selected part.

### MEMO

If you press the [HOLD] button to enable it, the arpeggio continues playing even after you take your hand off the keyboard.

5. **Use the [STYLE] (P-AMOUNT) knob to change the style (the pattern variations) of the arpeggio you're hearing.**

\* When the MODE is set to "I-ARP," the change in style is reflected once you play the keyboard again.

The arpeggio performance based on the keys you play changes according to the selected style.

For details, refer to "Parameter Guide" (PDF).

### MEMO

By setting the mode and style for other parts besides the currently selected part, you can make arpeggios play at the same time for multiple parts. Select the part to use by pressing the [PART/FUNC] button and then use the PART/OSC SELECT buttons.

6. **Press the I-ARPEGGIO [ON] button again to stop the arpeggio and turn it off.**

## Other Operation

### Specifying the arpeggio tempo (TEMPO)

You can specify the tempo of the arpeggio. Depending on the sound, LFO or DELAY can also synchronize to the tempo.

### Adjusting the amount of shuffle (SHUFFLE)

By varying the timing at which notes are sounded, you can create a shuffle rhythm.

When this setting is in the center position, notes are sounded at equal spacing. Increasing the value adds a shuffle feel like a dotted-note rhythm.

\* When you press the [PART/FUNC] button to make it light up blue and then operate the [TEMPO] (SHUFFLE) knob, the shuffle setting changes for all parts at the same time. (ARP COMMON > G-Shuffle)

### Changing the duration of the notes (DURATION)

You can specify the length during which each of the arpeggiated notes is heard. Shortening the duration produces a staccato feel, and lengthening the duration produces a tenuto feel.

\* When you use the [DURATION] knob, the duration for all parts changes at the same time. (ARP COMMON > G-Duration)

### Varying the arpeggio automatically

#### (PLAY DETECTOR)

Play Detector is a function that detects your keyboard playing and varies the arpeggio in real time.

\* If both PLAY DETECTOR KEYS and BEAT are turned "OFF," the current loop performance will repeat. This is useful when you want to continue playing for a while with the same accompaniment.

### Varying the arpeggio according to the harmony you play (PLAY DETECTOR KEYS)

When this is "ON," the arpeggio chords change according to the chords you play on the keyboard.

\* If you want to layer your keyboard performance without changing the chord, turn PLAY DETECTOR KEYS off.

### Varying the arpeggio according to the timing of your performance (PLAY DETECTOR BEAT)

When this is "ON," the pattern switches according to the rhythm, which is detected from the intervals between the notes you play on the keyboard.

\* Even if BEAT is off, the keyboard pitches are detected. If you want to maintain the sense of beat while you play a chord progression, turn PLAY DETECTOR BEAT off.



### Selecting the arpeggio type (ARP COMMON > TYPE)

This changes the arpeggio settings for parts 1–4 at the same time. Depending on the type, only one part might sound, or multiple parts might sound as an ensemble.

Select the type that is closest to the arpeggio that you have in mind, and then edit the sounds and parameters to bring it closer to your preferences.

\* With the factory settings, changing the type causes the parts whose Keyboard Sw is "OFF" to be assigned a sound (TONE) and volume (PART LEVEL) at the same time. If you want to change only the phrase while preserving the current sound settings, set the system parameter Arpeggio Set Tone to OFF.

### Selecting the rhythm type (ARP COMMON > RHYTHM)

You can change the phrase that is played by part R, which is the rhythm part.

Select a rhythm that is closest to what you have in mind, and then edit the tempo, drum kit, and the various parameters to bring it closer to your preferences.

\* With the factory settings, changing the rhythm causes a suitable tempo (TEMPO), sound (DRUM KIT) and volume (PART LEVEL) to be specified. If you want to change only the phrase while preserving the current tempo and sound settings, set the SYSTEM parameters Arpeggio Set Tempo and Arpeggio Set Drum kit respectively OFF.

### Editing the probability styles (\*1) (P-STYLE)

This determines whether each note to be played in the arpeggio should sound or not (the probability), and changes the arpeggio performance accordingly.

By changing the styles, you can change the note positions to which probability is applied.

When the arpeggiator normally plays, the same phrase is played over and over. However, by setting the probability, you can change the performance over time to create spontaneous phrases.

### Editing the probability strength (\*2) (P-AMOUNT)

This sets how much change is caused by the probability effect.

A 100% setting generates the original arpeggio phrase; and the closer the setting gets to 0%, the fewer the notes that play.

## Arpeggio phrases



### Probability style (\*1)

(The notes corresponding to the steps in the positions marked with a dot always play. The notes corresponding to the steps in the positions marked with a dash either play or not, depending on the probability ratio set in Amount.)



### Example of arpeggio phrase with probability applied (\*2)

(This example is with the Amount set to 50%. Notes in the positions marked with a dash play only 50% of the time.)

\* The phrase that plays back changes each time, based on the probability "Amount" setting.

## Using the Step Edit Function

The JUNO-X lets you edit arpeggio performance data using the TR-REC input method.

### What is TR-REC?

TR-REC is a method in which you use the [1]–[16] buttons to specify the timing at which each key plays a note. You can use it while listening to a rhythm that you created. For example to create the drum pattern shown in figure 1, you would make the settings shown in figure 2.

figure 1



figure 2

Step Number	01	02	03	04	05	06	07	08	09	10	11	12	13	14	15	16
Closed Hi-Hat	■	■	■	■	■	■	■	■	■	■	■	■	■	■	■	■
Snare Drum	□	□	□	□	□	□	□	□	□	□	□	□	□	□	□	□
Bass Drum	■	□	□	□	□	□	□	□	□	□	□	□	□	□	□	□

■ Button lit  
□ Button unlit

When pressing a key of its corresponding note that you want to edit, the [1]–[16] buttons light or go dark to indicate the steps on which that instrument will sound.

Pressing one of the [1]–[16] buttons switches it between lit and unlit, changing whether the instrument will or will not sound on that step.

## Editing Each Step of the Arpeggio Performance (STEP EDIT)

The arpeggio performance is always recorded inside the JUNO-X. If you like the performance, you can use the STEP EDIT function to extract and edit it.

The edited pattern can be used as a user pattern for the arpeggiator, or used in your computer as MIDI data.

You can also create a user pattern from a blank state without using recorded data.

### 1. Press the [STEP EDIT] button.

The arpeggio stops playing, and the STEP EDIT screen appears.

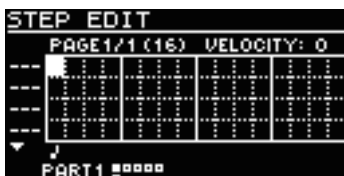

\* An empty STEP EDIT screen appears right after you press the [STEP EDIT] button.

### 2. Select the part to edit.

Select the part to edit (the current part) by pressing the [PART/FUNC] button and then using the PART/OSC SELECT [1]–[4] buttons ([4]–[8] buttons).

### 3. Press the [MENU] (WRITE) button.

The MENU screen for arpeggio play appears.

Here you can configure the basic settings for creating patterns, or copy existing patterns.

### SETTING

Configures the basic pattern settings.

Parameter	Explanation
Grid Note	Sets which notes are considered to be “one grid” for the arpeggio.
Grid Length	Sets the grid length of the arpeggio pattern.
Duration	Sets the length (ratio) used for playing back each note length in the arpeggio pattern.
Shuffle Rate	Creates a shuffle rhythm by varying the timing at which the upbeat notes play.
Shuffle Reso	This sets the note value that the shuffle is based on.
Offset Velo	Shifts the velocity value.
K-Range Lo	Specifies the lower pitch limit that is sounded by the arpeggio.
K-Range Oct	Specifies the number of higher octaves in which the arpeggio is sounded, relative to K-Range Lo.

### COPY from I-ARP

Copies the performance data from the I-ARPEGGIO for editing in the STEP EDIT screen.

\* You can use the [DUAL] (L/R DUAL) button to preview the data.

Commands	Explanation
Initialize	Clears the step data of all parts.
Current	Loads the current step data.
Latest	Loads the most recently recorded data.
1 time before	Loads the recorded data from one pass before.
2 times before	Loads the recorded data from two passes before.
3 times before	Loads the recorded data from three passes before.
4 times before	Loads the recorded data from four passes before.

\* A “pass” means the length of the arpeggio pattern, set in “Grid Length.”

### COPY from SCENE

Copies the performance data you like from a scene for editing in the STEP EDIT screen.

### ERASE CURRENT PART

Erases the performance data from the current part.

### ERASE ALL PART

Erases the performance data from all parts.

### 4. After making the settings, press the [ENTER] (INIT) button to return to the STEP EDIT screen.

The changes made on the MENU screen are also applied to the STEP EDIT screen.

### 5. Edit using the STEP EDIT screen.

The following shows how to use the operations in the STEP EDIT screen.

Item	Operation
Move left/right between steps	[◀] [▶] buttons
Shift steps up/down	[▲SELECT▼] knob
Move between pages	Hold down the [SHIFT] button and press the [◀] [▶] button.
Specify the note	Press a key
Specify a step and turn the note on	The values set just before the steps are used for the velocity values of the [1]–[16] buttons.
Edit the velocity value	[- VALUE +] knob
Turn the currently selected note on/off	[ENTER] (INIT) button



Item	Operation
Input a tie	Move the cursor to the beginning of the tie, then hold down the [SHIFT] button and press the [1]–[16] button that corresponds to the last step of the tie.
Move the part	Press the [PART/FUNC] button to select the current part
Edit the grid length	Hold down the [SHIFT] button and operate the [▲SELECT▼] knob
Record a step	A note is input for each step when you play the keyboard while the [SPLIT] (●) button is lit.
Record in real time	Notes are recorded in real time when you play the keyboard during preview playback while the [SPLIT] (●) button is lit.
Erase all data of the selected note	Press the [SINGLE] (ERASE) button while holding down a key
Erase all data of the selected step	Press the [SINGLE] (ERASE) button while holding down [1]–[16] buttons
Erase all data from the currently selected part	[SINGLE] (ERASE) button
Exit step edit and return to the top screen	[EXIT] button

## 6. Check what you edited while pressing the [▶/■] button to play/stop your performance.

\* The values specified for the arpeggio are applied to the number of steps and the settings such as grid and shuffle.

## 7. To edit the basic settings for the arpeggio, exit the STEP EDIT screen and use the ARP PART EDIT screen.

\* You can use the [TEMPO] (SHUFFLE) knob to change the tempo.

## 8. When you finish editing, save the result as a scene.

➔ “Saving the Scene Settings (SCENE WRITE)” (p. 24)

If you want to use the data on your computer as MIDI data, use the export function.

➔ “Using the IMPORT/EXPORT Function” (p. 46)

## Playing a Pattern You Entered

The data that you edit in STEP EDIT can actually be used for arpeggio performance.

### 1. Press the [MENU] (WRITE) button.

### 2. Use the [▲SELECT▼] knob to select “ARPEGGIO EDIT,” and then press the [ENTER] (INIT) button.

The ARP PART EDIT screen appears.

### 3. Use the [▲SELECT▼] knob to select “Arp Mode” and use the [- VALUE +] knob to change the setting to “STEP.”

#### MEMO

To make the pitch change according to what you play on the keyboard, set “Step Key Shift” to “ON.”

## If the Keyboard Does Not Play Sound

Here we explain situations in which playing the keyboard does not produce sound properly even though the KEYBOARD SW is on.

### 01 When I-ARPEGGIO is on, and “ARP PART EDIT: Switch” is ON

This part is played by the arpeggio, and cannot be played from the keyboard.

To play it from the keyboard, set “ARP PART EDIT: Switch” to “OFF.”

### 02 When one of the ASSIGN settings in SCENE COMMON EDIT is PART FADE1/PART FADE2

The volume of parts whose Keyboard Sw is on is controlled by the controller that is assigned to PART FADE1/PART FADE2, so sound might not be heard depending on the setting of the controller.

If you want to always play the corresponding part from the keyboard, assign all of the SL1, SL2, and Ctrl settings to something other than PART FADE1/PART FADE2.

Alternatively, if only one Keyboard Sw is on, the PART FADE effect is disabled, and you can play just the corresponding part.

### 03 When Part Sw is off

You can switch the parts on/off when the [PART/FUNC] button is lit up yellow, by holding down the [SHIFT] button and pressing the PART/OSC ON [1]–[R] buttons ([9]–[13] buttons).

If you accidentally turn this off, the corresponding part won't produce sound.

Normally you'll leave all Part Sw settings on.

### 04 If a volume or similar setting is lowered

The corresponding part will not be heard if one of the volume settings is lowered.

There are many parameters related to volume. To restore the sound so that it plays normally, switch to a different scene to clear out the settings. In this case, the current scene settings will be lost, so save the scene before you try this.

# Editing a Scene (SCENE EDIT)

## Scene Edit/Part Edit

Detailed settings can be made using the edit pages, which you can access from the SCENE TOP screen by using the [◀] [▶] buttons.

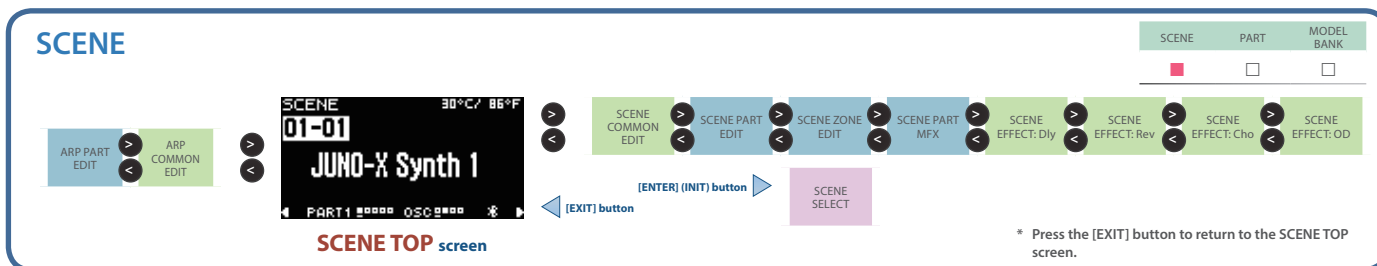

## Configuring Scene Common Settings (Scene Edit)

The scene edit pages let you make settings that are common to the scene.

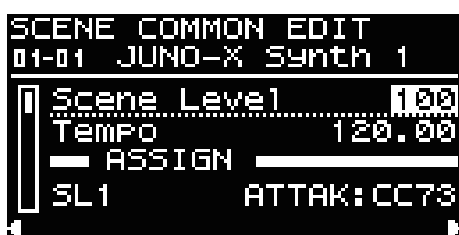

### 1. Press the [SCENE] button.

The SCENE TOP screen appears.

#### MEMO

If you hold down the [SCENE] button and press the [PART/FUNC] button, the part list screen appears.

### 2. Use the [◀] [▶] buttons to move to the scene edit page for the item that you want to edit.

### 3. Use the [▲SELECT▼] knob to select the parameter that you want to edit, and use the [- VALUE +] knob to change the value.

For details, refer to "Parameter Guide" (PDF).

### 4. If you want to save the setting, execute the Scene Write operation.

\* If you want to save a tone individually, use the tone write operation (p. 26).

#### 4-1. Hold down the [SHIFT] button and press the [MENU] (WRITE) button.

The WRITE MENU screen appears.

#### 4-2. Use the [▲SELECT▼] knob to select "SCENE," and then press the [ENTER] (INIT) button.

#### 4-3. Use the [▲SELECT▼] knob and the [- VALUE +] knob to select the save-destination, and then press the [ENTER] (INIT) button.

To rename the scene that's being saved, use the [◀] [▶] buttons to move the cursor and use the [- VALUE +] knob to select the characters.

#### 4-4. Press the [ENTER] (INIT) button.

#### 4-5. To execute, press the [ENTER] (INIT) button.

## Basic settings related to I-Arpeggio

### (ARP COMMON EDIT)

These are I-Arpeggio basic settings. You can also specify the rhythm pattern that's used for arpeggio performance, and the keyboard region that is detected by I-Arpeggio.

## Basic settings for scenes (SCENE COMMON EDIT)

These are basic settings for scenes.

These settings let you assign functions to controllers such as the buttons or knobs, and configure the settings for controlling an external device.

## Delay settings (SCENE EFFECT: Dly)

These are settings for the delay that is used in common by all parts.

\* These settings are valid only if the "SYSTEM EFFECT: Dly" source is set to "SCENE."

→ "Editing the System Settings (System)" (p. 43)

## Reverb settings (SCENE EFFECT: Rev)

These are settings for the reverb that is used in common by all parts.

\* These settings are valid only if the "SYSTEM EFFECT: Rev" source is set to "SCENE."

→ "Editing the System Settings (System)" (p. 43)

## Chorus settings (SCENE EFFECT: Cho)

These are settings for the chorus that is used in common by all parts.

\* These settings are valid only if the "SYSTEM EFFECT: Cho" source is set to "SCENE."

→ "Editing the System Settings (System)" (p. 43)

## Overdrive settings (SCENE EFFECT: OD)

These are settings for the overdrive that is used in common by all parts.

\* These settings are valid only for parts whose "SCENE PART EDIT" setting "Output" is set to "DRIVE."

→ "Editing a Scene (SCENE EDIT)" (p. 22)

### MEMO

One effect such as chorus and delay can be used for each scene, and you can specify its depth for each part.

If you want to use different effects for each part, specify the effects individually from "SCENE PART MFX" or "TONE MFX."

→ "Effect settings for each part (SCENE PART MFX)" (p. 23)

→ "Editing a Tone (TONE EDIT)" (p. 25)

## Configuring the Performance Style, Controllers and Other Settings (Part Edit)

Part edit lets you make settings for performance style and controller settings, and for individual effects.

To edit the actual tone that is assigned to a part, use tone edit.

→ "Editing a Tone (TONE EDIT)" (p. 25)

### 1. Press the [SCENE] button.

The SCENE TOP screen appears.

### 2. Press the [PART/FUNC] button to switch to part select mode, and press the [4]–[8] buttons to select the part that you want to edit.

By pressing two or more of the PART/OSC SELECT [1]–[R] buttons (the [4]–[8] buttons) simultaneously, you can select multiple parts to edit together.

### MEMO

- If multiple parts are selected, the part that you press first is selected as the current part.
- The display shows the information of the current part.
- Even if you make the identical settings for LFO parameters such as LFO TYPE and LFO RATE when multiple parts are selected, the LFO effect will differ because the start timing differs for each part.

### 3. Use the [◀] [▶] buttons to move to the part edit page of the item that you want to edit.

### 4. Use the [▲SELECT▼] knob to select the parameter, and use the [- VALUE +] knob to change the value.

For details, refer to "Parameter Guide" (PDF).

### 5. If you want to save the setting, execute the Scene Write operation.

#### 5-1. Hold down the [SHIFT] button and press the [MENU] (WRITE) button.

The WRITE MENU screen appears.

#### 5-2. Use the [▲SELECT▼] knob to select "SCENE," and then press the [ENTER] (INIT) button.

#### 5-3. Use the [▲SELECT▼] knob and the [- VALUE +] knob to select the save-destination, and then press the [ENTER] (INIT) button.

To rename the scene that's being saved, use the [◀] [▶] buttons to move the cursor and use the [- VALUE +] knob to select the characters.

#### 5-4. Press the [ENTER] (INIT) button.

#### 5-5. To execute, press the [ENTER] (INIT) button.

## I-Arpeggio settings for each part (ARP PART EDIT)

These are I-Arpeggio settings that are specific to each part.

You can make settings for the expression and notes of the arpeggio performance, and specify the region in which it plays.

## Basic settings for each part (SCENE PART EDIT)

These are basic settings for each part.

You can specify how the data received from controllers is handled to make the tone produce sound, and specify how the sound of the tone is output as audio data.

## Zone settings for each part (SCENE ZONE EDIT)

For each part, you can specify whether controller information will be received.

You can also specify a fade-out between the keyboard regions that produce sound.

## Effect settings for each part (SCENE PART MFX)

These are effect settings for each part.

These are valid if "FillwToneMFX" is "OFF"; if this is "ON," the tone effect is used instead of the part effect.

This is recommended if you want to leave the effect fixed while you switch the tone.

→ "Editing a Tone (TONE EDIT Screen)" (p. 25)

### Saving the Scene Settings (SCENE WRITE)

Scene settings that you edit are lost when you turn off the power or switch to another scene. By writing the scene, you can save the edited settings.

The JUNO-X can store a total of 256 scenes, organized as 16 banks each containing 16 scenes.

\* If you want to save a tone individually, use the tone write operation (p. 26).

#### 1. Hold down the [SHIFT] button and press the [MENU] (WRITE) button.

The WRITE MENU screen appears.

If saving is needed, the screen indicates "EDITED."

If the PART 1–4 tones are indicated as "EDITED," and you want to save the complete sound, save the tones first.

→ "Saving the Tone Settings (TONE WRITE)" (p. 26)

#### 2. Use the [▲SELECT▼] knob to select "SCENE," and then press the [ENTER] (INIT) button.

#### 3. Use the [▲SELECT▼] knob and the [- VALUE +] knob to select the scene to save to, and then press the [ENTER] (INIT) button.

To rename the scene, use the [◀] [▶] buttons to move the cursor and use the [- VALUE +] knob to select the characters.

#### 4. Press the [ENTER] (INIT) button.

A confirmation message appears.

If you decide to cancel, press the [EXIT] button.

#### 5. To execute, press the [ENTER] (INIT) button.

### Initializing a Scene (SCENE INITIALIZE)

By initializing a scene, you can put the scene settings in their default state.

\* When you initialize a scene, all settings saved in the scene are erased. Please note that the data cannot be recovered.

\* Initializing the scene settings also initializes the tones of PART 1–4 at the same time.

#### 1. Hold down the [SHIFT] button and press the [ENTER] (INIT) button.

The INITIALIZE MENU screen appears.

#### 2. Use the [▲SELECT▼] knob to select "SCENE."

#### 3. Press the [ENTER] (INIT) button.

A confirmation message appears.

If you decide to cancel, press the [EXIT] button.

#### 4. To execute, press the [ENTER] (INIT) button.

### Using the Scene Lock Function

By using the scene lock function, you can make a confirmation screen appear when you change scenes. This helps keep you from accidentally selecting a different scene when you haven't saved the scene.

#### 1. Press the [MENU] (WRITE) button.

The setting screen appears.

#### 2. Use the [▲SELECT▼] knob to select "SYSTEM," and then press the [ENTER] (INIT) button.

#### 3. Use the [▲SELECT▼] knob to select "Scene Lock," and use the [- VALUE +] knob to set the value to "ON."

#### 4. To save the settings, hold down the [SHIFT] button and press the [MENU] (WRITE) button.

A confirmation message appears.

If you decide to cancel, press the [EXIT] button.

#### 5. To execute, press the [ENTER] (INIT) button.

# Editing a Tone (TONE EDIT)

With the JUNO-X, you can add a variety of effects to process the tones, and you can use the controllers such as the buttons and knobs to edit the tones themselves.

## \*Elements of a tone (expanded view)

• Model: JUNO-X, JUNO-106, JUNO-60

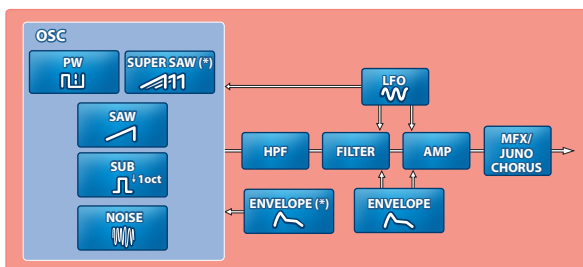

Elements marked with an asterisk (\*) are enabled only for the JUNO-X model.

\* Some functions may vary, depending on the model.

• Model: XV-5080, RD-PIANO, etc.

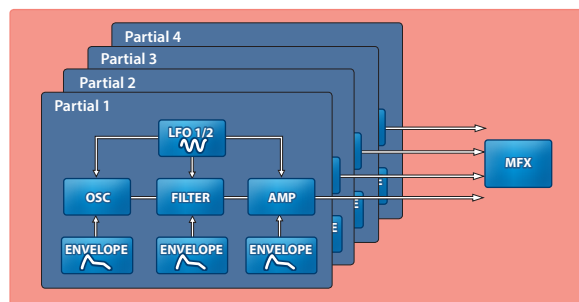

Pitch information for the key you play is sent to the oscillator, and is output as sound via the mixer, filter, and amp etc. The change produced by each section can be modified using an LFO or envelope.

## Editing a Tone (TONE EDIT Screen)

From the MODEL BANK TOP screen, you can use the [◀] [▶] buttons to move to the pages at the right, and edit the tone from the tone edit pages.

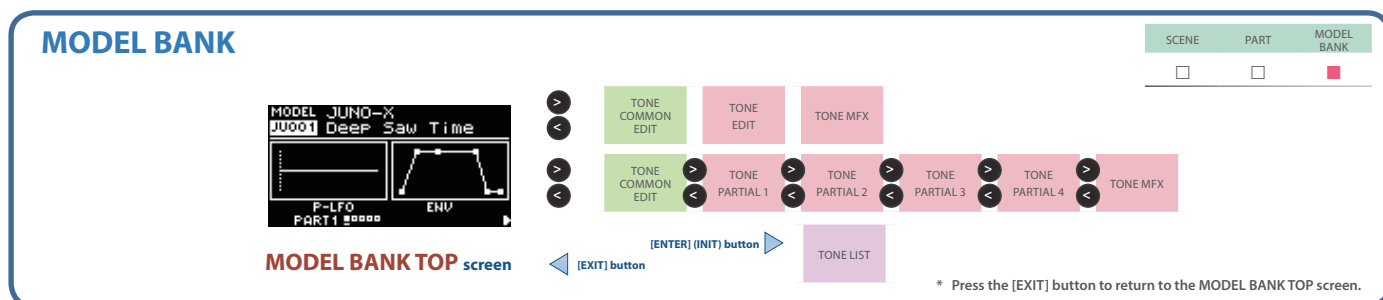

\* You can also access the tone edit pages from the MENU screen.

→ “Accessing the MENU Screen” (p. 42)

### 1. Press the [MODEL BANK] button.

The MODEL BANK screen appears.

\* Only some models allow multiple selection.

### 2. Use the [◀] [▶] buttons to move to the tone edit page of the item that you want to edit.

### 3. Use the [▲SELECT▼] knob to select the parameter that you want to edit, and use the [- VALUE +] knob to change the value.

For details, refer to “Parameter Guide” (PDF).

### 4. If you want to save the setting, execute the Tone Write operation.

4-1. Hold down the [SHIFT] button and press the [MENU] (WRITE) button.

The WRITE MENU screen appears.

4-2. Use the [▲SELECT▼] knob to select the part where the tone you want to save is assigned, and then press the [ENTER] (INIT) button.

4-3. Use the [▲SELECT▼] knob and the [- VALUE +] knob to select the save-destination, and then press the [ENTER] (INIT) button.

If you want to rename the tone that's being saved, use the [◀] [▶] buttons to move the cursor and use the [- VALUE +] knob to specify characters.

4-4. Press the [ENTER] (INIT) button.

4-5. To execute, press the [ENTER] (INIT) button.

### Editing Basic Settings for the Tone

#### (TONE COMMON EDIT)

Here's how to make basic settings for the tone, such as its volume, pitch, and whether various functions are used.

In this page you can edit parameters that are common to all partials.

### Editing the Parameters of Each Section

#### (TONE EDIT)

Here you can edit the parameters of each section, such as the oscillator and filter.

Depending on the model, the screens are divided into PARTIAL 1–4.

### Editing the Effects (TONE MFX)

You can edit the effects for each tone.

This is valid if the "SCENE PART MFX" parameter "FlwToneMFX" is "ON"; if that parameter is "OFF," the part effect is used instead of the tone effect.

This is recommended if you want to make effect settings individually for each user tone.

→ "Configuring the Performance Style, Controllers and Other Settings (Part Edit)" (p. 23)

### Duplicating a Partial (PARTIAL COPY)

For models such as "XV-5080" or "RD-PIANO" which allow each partial to be edited, you can copy the parameters of the currently selected partial to another partial.

#### NOTE

Be aware that an overwrite-saved tone cannot be restored to its previous state.

- 1. From the MODEL BANK screen or the MENU screen, access the "TONE EDIT" screen.**  
→ "Accessing the MENU Screen" (p. 42)
- 2. Press the [PART/FUNC] button to make it light up blue, and then press the PART/OSC SELECT [1]–[4] buttons to select the copy source partial.**
- 3. While holding down the [SHIFT] button, press one of the OSC SELECT [1]–[4] buttons to select the copy-destination partial.**  
A confirmation message appears.  
If you decide to cancel, press the [EXIT] button.
- 4. To execute, press the [ENTER] (INIT) button.**

### Saving the Tone Settings (TONE WRITE)

A tone that you create will change if you move a knob or select another tone. It also disappears when you power-off the JUNO-X.

When you've created a tone that you like, you should save it as a user tone.

- 1. Hold down the [SHIFT] button and press the [MENU] (WRITE) button.**  
The WRITE MENU screen appears.
- 2. Use the [▲SELECT▼] knob to select the part where the tone you want to save is assigned, and then press the [ENTER] (INIT) button.**
- 3. Use the [▲SELECT▼] knob and the [- VALUE +] knob to select the save-destination, and then press the [ENTER] (INIT) button.**  
If you want to rename the tone that's being saved, use the [◀] [▶] buttons to move the cursor and use the [- VALUE +] knob to specify characters.
- 4. Press the [ENTER] (INIT) button.**  
A confirmation message appears.  
If you decide to cancel, press the [EXIT] button.
- 5. To execute, press the [ENTER] (INIT) button.**

### Initializing a Tone (TONE INITIALIZE)

Here's how to initialize the tone of the current part. The initial state that is specified differs depending on the model that is selected for that part.

- 1. Press the [MODEL BANK] button to switch to tone select mode.**
- 2. Use the [▲SELECT▼] knob to move the cursor to the model name.**
- 3. Turn the [- VALUE +] knob to select the model to use for initializing the tone.**
- 4. Hold down the [SHIFT] button and press the [ENTER] (INIT) button.**  
The INITIALIZE MENU screen appears.
- 5. Use the [▲SELECT▼] knob to select "TONE."**
- 6. Press the [ENTER] (INIT) button.**  
A confirmation message appears.  
If you decide to cancel, press the [EXIT] button.
- 7. To execute, press the [ENTER] (INIT) button.**



# Correspondence Between Controllers and Parameters

## JUNO-X

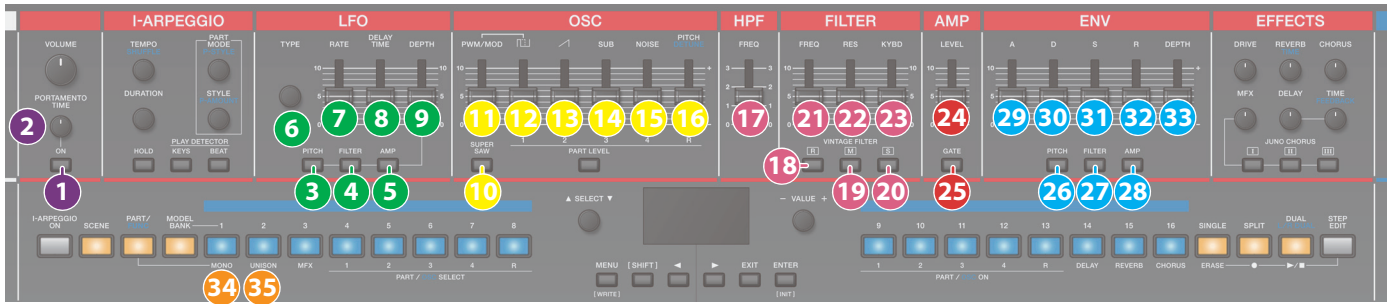

Section	Controller	Parameter	Destination or operation when used with the [SHIFT] button	
PORTAMENTO	1 ON	Select PORTA ON	<b>JUNO-X TONE EDIT:</b> PORTA MODE	
	2 TIME	PORTA TIME	<b>JUNO-X TONE EDIT:</b> PORTA TIME	
LFO	3 PITCH	Select PITCH LFO	-	
	4 FILTER	Select FILTER LFO	-	
	5 AMP	Select AMP LFO	-	
	6 TYPE	LFO WAVEFORM	<b>JUNO-X TONE EDIT:</b> LFO WAVEFORM	
	7 RATE	<b>If "LFO SYNC" is OFF</b> LFO RATE <b>If "LFO SYNC" is ON</b> LFO NOTE	<b>JUNO-X TONE EDIT:</b> LFO RATE <b>JUNO-X TONE EDIT:</b> LFO NOTE	
	8 DELAY TIME	LFO DELAY TIME	<b>JUNO-X TONE EDIT:</b> LFO DELAY TIME	
	9 DEPTH	<b>If "PITCH LFO" is selected</b>	OSC LFO MOD	<b>JUNO-X TONE EDIT:</b> OSC LFO MOD
		<b>If "FILTER LFO" is selected</b>	FILTER MOD	<b>JUNO-X TONE EDIT:</b> FILTER MOD
		<b>If "AMP LFO" is selected</b>	AMP MOD	<b>JUNO-X TONE EDIT:</b> AMP MOD
OSC	10 SUPER SAW	Select SUPER SAW ON	<b>JUNO-X TONE EDIT:</b> SUPER SAW	
	11 PWM/MOD	<b>If SUPER SAW is OFF</b> PULSE WIDTH MOD	<b>JUNO-X TONE EDIT:</b> PULSE WIDTH MOD	
		<b>If SUPER SAW is ON</b> SSAW DETUNE	<b>JUNO-X TONE EDIT:</b> SSAW DETUNE	
	12 [L] [R]	<b>If SUPER SAW is OFF</b> PW LEVEL	<b>JUNO-X TONE EDIT:</b> PW LEVEL	
		<b>If SUPER SAW is ON</b> SSAW LEVEL	<b>JUNO-X TONE EDIT:</b> SSAW LEVEL	
	13 [ / ]	SAW LEVEL	<b>JUNO-X TONE EDIT:</b> SAW LEVEL	
	14 SUB	SUB LEVEL	<b>JUNO-X TONE EDIT:</b> SUB LEVEL	
	15 NOISE	NOISE LEVEL	<b>JUNO-X TONE EDIT:</b> NOISE LEVEL	
16	PITCH	OSC PITCH	<b>JUNO-X TONE EDIT:</b> OSC PITCH	
	DETUNE	OSC DETUNE (*1)	<b>JUNO-X TONE EDIT:</b> OSC DETUNE	
HPF	17	FREQ	HPF-STEP	<b>JUNO-X TONE EDIT:</b> HPF-STEP

Section	Controller	Parameter	Destination or operation when used with the [SHIFT] button
FILTER	18 [R]		
	19 [M]	Select FILTER TYPE	<b>JUNO-X TONE EDIT:</b> VINTAGE FLT TYPE
	20 [S]		
AMP	21 FREQ	CUTOFF	<b>JUNO-X TONE EDIT:</b> CUTOFF
	22 RES	RESONANCE	<b>JUNO-X TONE EDIT:</b> RESONANCE
	23 KYBD	FLT KEY FOLLOW	<b>JUNO-X TONE EDIT:</b> FLT KEY FOLLOW
AMP	24 GATE	Select G-AMP	<b>JUNO-X TONE EDIT:</b> AMP ENV SEL
	25 LEVEL	AMP LEVEL	<b>JUNO-X TONE EDIT:</b> AMP LEVEL
ENV	26 PITCH	Select PITCH ENV	-
	27 FILTER	Select FILTER ENV	-
	28 AMP	Select ENV F&A	-
	29 A	<b>If "PITCH ENV" is selected</b> PENV ATTACK	<b>JUNO-X TONE EDIT:</b> PENV ATTACK
		<b>If "FILTER ENV" and "ENV F&amp;A" are selected</b> ENV ATTACK	<b>JUNO-X TONE EDIT:</b> ENV ATTACK
	30 D	<b>If "PITCH ENV" is selected</b> PENV DECAY	<b>JUNO-X TONE EDIT:</b> PENV DECAY
		<b>If "FILTER ENV" and "ENV F&amp;A" are selected</b> ENV DECAY	<b>JUNO-X TONE EDIT:</b> ENV DECAY
	31 S	<b>If "PITCH ENV" is selected</b> PENV SUSTAIN	<b>JUNO-X TONE EDIT:</b> PENV SUSTAIN
		<b>If "FILTER ENV" and "ENV F&amp;A" are selected</b> ENV SUSTAIN	<b>JUNO-X TONE EDIT:</b> ENV SUSTAIN
	32 R	<b>If "PITCH ENV" is selected</b> PENV RELEASE	<b>JUNO-X TONE EDIT:</b> PENV RELEASE
		<b>If "FILTER ENV" and "ENV F&amp;A" are selected</b> ENV RELEASE	<b>JUNO-X TONE EDIT:</b> ENV RELEASE
33 DEPTH	<b>If "PITCH ENV" is selected</b> PENV DEPTH	<b>JUNO-X TONE EDIT:</b> PENV DEPTH	
	<b>If "FILTER ENV" and "ENV F&amp;A" are selected</b> FLT ENV DEPTH	<b>JUNO-X TONE EDIT:</b> FLT ENV DEPTH	
PART/FUNC	34 MONO	Select SOLO	<b>JUNO-X TONE EDIT:</b> KEY MODE
	35 UNISON	Select UNISON	<b>JUNO-X TONE EDIT:</b> KEY MODE

(\*1): Only enabled in FUNC mode.

\* For other parameters, refer to "Parameter Guide" (PDF).

# JUNO-106

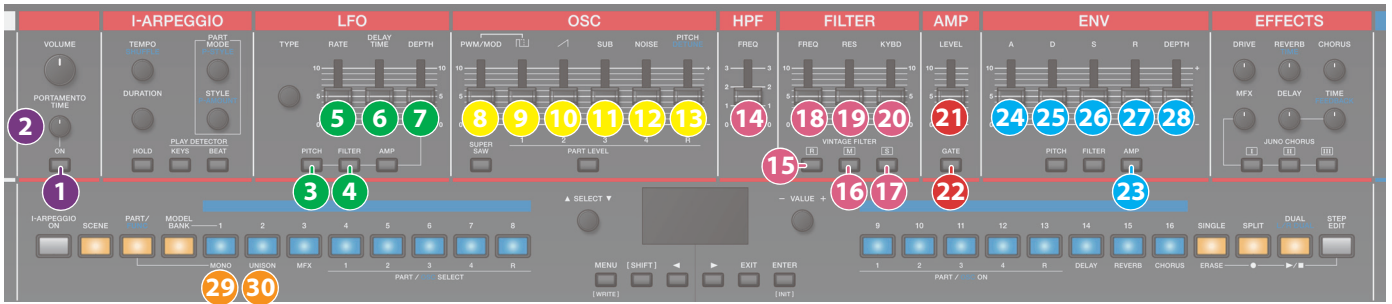

Section	Controller	Parameter	Destination or operation when used with the [SHIFT] button
PORTAMENTO	1 ON	Select PORTA ON	<b>JUNO-106 TONE EDIT:</b> PORTA MODE
	2 TIME	PORTA TIME	<b>JUNO-106 TONE EDIT:</b> PORTA TIME
LFO	3 PITCH	Select PITCH LFO	-
	4 FILTER	Select FILTER LFO	-
	5 RATE	LFO RATE	<b>JUNO-106 TONE EDIT:</b> LFO RATE
	6 DELAY TIME	LFO DELAY TIME	<b>JUNO-106 TONE EDIT:</b> LFO DELAY TIME
	7 DEPTH	If "PITCH-LFO" is selected OSC LFO MOD If "FILTER-LFO" is selected FILTER MOD	<b>JUNO-106 TONE EDIT:</b> OSC LFO MOD
OSC	8 PWM/MOD	PULSE WIDTH MOD	<b>JUNO-106 TONE EDIT:</b> PULSE WIDTH MOD
	9 [L]	PW SWITCH	<b>JUNO-106 TONE EDIT:</b> PW SWITCH
	10 [ / ]	SAW SWITCH	<b>JUNO-106 TONE EDIT:</b> SAW SWITCH
	11 SUB	SUB LEVEL	<b>JUNO-106 TONE EDIT:</b> SUB LEVEL
	12 NOISE	NOISE LEVEL	<b>JUNO-106 TONE EDIT:</b> NOISE LEVEL
HPF	13 PITCH	OSC RANGE	<b>JUNO-106 TONE EDIT:</b> OSC RANGE
FILTER	14 FREQ	HPF-STEP	<b>JUNO-106 TONE EDIT:</b> HPF-STEP
	15 [R]		
	16 [M]	Select FILTER TYPE	<b>JUNO-106 TONE EDIT:</b> VINTAGE FLT TYPE
	17 [S]		
	18 FREQ	CUTOFF	<b>JUNO-106 TONE EDIT:</b> CUTOFF
	19 RES	RESONANCE	<b>JUNO-106 TONE EDIT:</b> RESONANCE
AMP	20 KYBD	FLT KEY FOLLOW	<b>JUNO-106 TONE EDIT:</b> FLT KEY FOLLOW
	21 GATE	Select G-AMP	<b>JUNO-106 TONE EDIT:</b> AMP ENV SEL
	22 LEVEL	AMP LEVEL	<b>JUNO-106 TONE EDIT:</b> AMP LEVEL

Section	Controller	Parameter	Destination or operation when used with the [SHIFT] button
ENV	23 AMP	Select ENV F&A	-
	24 A	ENV ATTACK	<b>JUNO-106 TONE EDIT:</b> ENV ATTACK
	25 D	ENV DECAY	<b>JUNO-106 TONE EDIT:</b> ENV DECAY
	26 S	ENV SUSTAIN	<b>JUNO-106 TONE EDIT:</b> ENV SUSTAIN
	27 R	ENV RELEASE	<b>JUNO-106 TONE EDIT:</b> ENV RELEASE
	28 DEPTH	FLT ENV DEPTH	<b>JUNO-106 TONE EDIT:</b> FLT ENV DEPTH
PART/FUNC	29 MONO	Select SOLO	<b>JUNO-106 TONE EDIT:</b> KEY MODE
	30 UNISON	Select UNISON	<b>JUNO-106 TONE EDIT:</b> KEY MODE

\* For other parameters, refer to "Parameter Guide" (PDF).



# JUNO-60

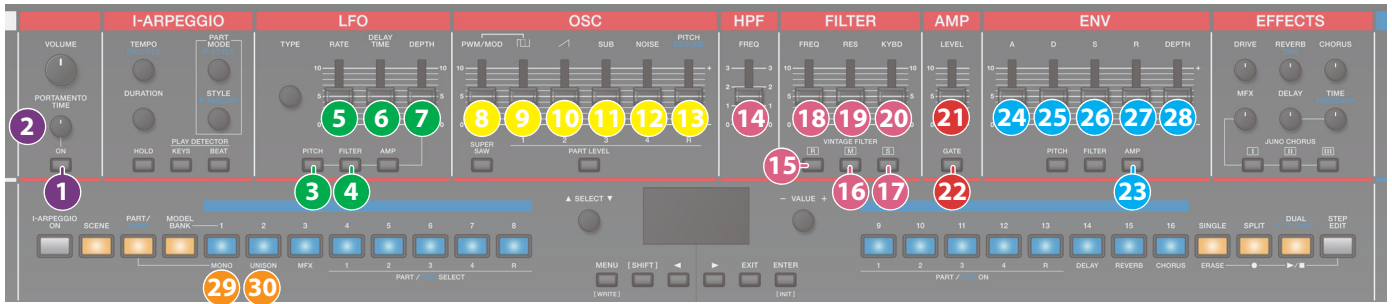

Section	Controller	Parameter	Destination or operation when used with the [SHIFT] button
PORTAMENTO	1 ON	Select PORTA ON	<b>JUNO-60 TONE EDIT:</b> PORTA MODE
	2 TIME	PORTA TIME	<b>JUNO-60 TONE EDIT:</b> PORTA TIME
LFO	3 PITCH	Select PITCH LFO	-
	4 FILTER	Select FILTER-LFO	-
	5 RATE	LFO RATE	<b>JUNO-60 TONE EDIT:</b> LFO RATE
	6 DELAY TIME	LFO DELAY TIME	<b>JUNO-60 TONE EDIT:</b> LFO DELAY TIME
LFO	7 DEPTH	<b>If "PITCH LFO" is selected</b> OSC LFO MOD <b>JUNO-60 TONE EDIT:</b> OSC LFO MOD	<b>JUNO-60 TONE EDIT:</b> OSC LFO MOD
	7 DEPTH	<b>If "FILTER LFO" is selected</b> FILTER MOD <b>JUNO-60 TONE EDIT:</b> FILTER MOD	<b>JUNO-60 TONE EDIT:</b> FILTER MOD
OSC	8 PWM/MOD	PULSE WIDTH MOD	<b>JUNO-60 TONE EDIT:</b> PULSE WIDTH MOD
	9 Π	PW SWITCH	<b>JUNO-60 TONE EDIT:</b> PW SWITCH
	10 /	SAW SWITCH	<b>JUNO-60 TONE EDIT:</b> SAW SWITCH
	11 SUB	SUB LEVEL	<b>JUNO-60 TONE EDIT:</b> SUB LEVEL
	12 NOISE	NOISE LEVEL	<b>JUNO-60 TONE EDIT:</b> NOISE LEVEL
	13 PITCH	OCTAVE	<b>JUNO-60 TONE EDIT:</b> OCTAVE
HPF	14 FREQ	HPF-STEP	<b>JUNO-60 TONE EDIT:</b> HPF-STEP
FILTER	15 [R]	Select FILTER TYPE	<b>JUNO-60 TONE EDIT:</b> VINTAGE FLT TYPE
	16 [M]		
	17 [S]		
	18 FREQ	CUTOFF	<b>JUNO-60 TONE EDIT:</b> CUTOFF
	19 RES	RESONANCE	<b>JUNO-60 TONE EDIT:</b> RESONANCE
AMP	20 KYBD	FLT KEY FOLLOW	<b>JUNO-60 TONE EDIT:</b> FLT KEY FOLLOW
	21 GATE	Select G-AMP	<b>JUNO-60 TONE EDIT:</b> AMP ENV SEL
	22 LEVEL	AMP LEVEL	<b>JUNO-60 TONE EDIT:</b> AMP LEVEL

Section	Controller	Parameter	Destination or operation when used with the [SHIFT] button
ENV	23 AMP	Select ENV F&A	-
	24 A	ENV ATTACK	<b>JUNO-60 TONE EDIT:</b> ENV ATTACK
	25 D	ENV DECAY	<b>JUNO-60 TONE EDIT:</b> ENV DECAY
	26 S	ENV SUSTAIN	<b>JUNO-60 TONE EDIT:</b> ENV SUSTAIN
	27 R	ENV RELEASE	<b>JUNO-60 TONE EDIT:</b> ENV RELEASE
	28 DEPTH	FLT ENV DEPTH	<b>JUNO-60 TONE EDIT:</b> FLT ENV DEPTH
PART/FUNC	29 MONO	Select SOLO	<b>JUNO-60 TONE EDIT:</b> KEY MODE
	30 UNISON	Select UNISON	<b>JUNO-60 TONE EDIT:</b> KEY MODE

\* For other parameters, refer to "Parameter Guide" (PDF).

XV-5080, RD-PIANO, and Other Tones (When the [SCENE] Button Is Lit)

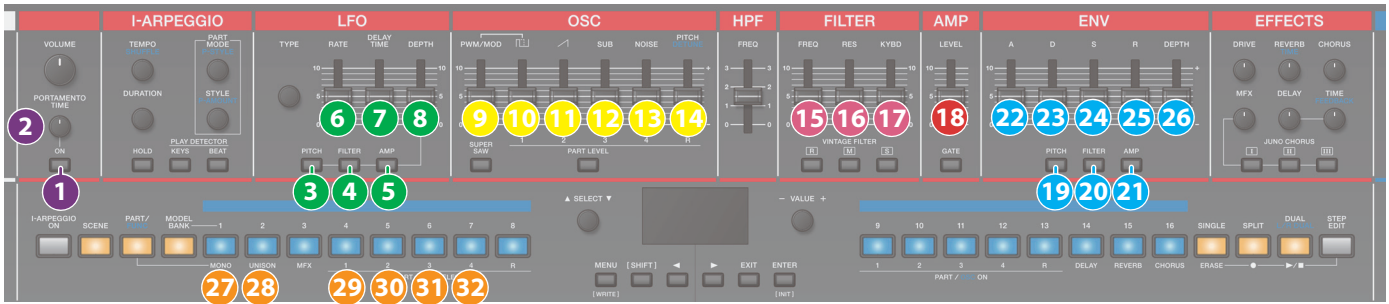

Section	Controller	Parameter	Destination or operation when used with the [SHIFT] button	
PORTAMENTO	1 ON	Porta Sw	<b>TONE COMMON EDIT:</b> Porta Sw	
	2 TIME	Porta Time	<b>SCENE PART EDIT:</b> <b>CTRL:</b> Porta Time	
LFO	3 PITCH	Select PITCH LFO (*1)	-	
	4 FILTER	Select FILTER LFO (*1)	-	
	5 AMP	Select AMP LFO (*1)	-	
	6 RATE	Vib Rate	<b>SCENE PART EDIT:</b> <b>MODIFY:</b> Vib Rate	
LFO	7 DELAY TIME	Vib Delay	<b>SCENE PART EDIT:</b> <b>MODIFY:</b> Vib Delay	
	8 DEPTH	If "PITCH LFO" is selected Pit LFO Dep	<b>SCENE PART EDIT:</b> <b>LFO:</b> Pit LFO Dep	
		If "FILTER LFO" is selected Filt LFO Dep	<b>SCENE PART EDIT:</b> <b>LFO:</b> Filt LFO Dep	
	8 DEPTH	If "AMP LFO" is selected Amp LFO Dep	<b>SCENE PART EDIT:</b> <b>LFO:</b> Amp LFO Dep	
OSC		9 PWM/MOD	Fine Tune	<b>SCENE PART EDIT:</b> <b>PITCH:</b> Fine Tune
	10 Π	Partial1 Level	<b>TONE EDIT PARTIAL1:</b> <b>Tone PTL:</b> Level	
	11 /	Partial2 Level	<b>TONE EDIT PARTIAL2:</b> <b>Tone PTL:</b> Level	
	12 SUB	Partial3 Level	<b>TONE EDIT PARTIAL3:</b> <b>Tone PTL:</b> Level	
	13 NOISE	Partial4 Level	<b>TONE EDIT PARTIAL4:</b> <b>Tone PTL:</b> Level	
OSC	14 PITCH	Coarse Tune	<b>SCENE PART EDIT:</b> <b>PITCH:</b> Coarse Tune	
	FILTER	15 FREQ	Cutoff	<b>SCENE PART EDIT:</b> <b>MODIFY:</b> Cutoff
		16 RES	Resonance	<b>SCENE PART EDIT:</b> <b>MODIFY:</b> Resonance
17 KYBD		Filt KeyFillw	<b>SCENE PART EDIT:</b> <b>FILTER:</b> Filt KeyFillw	
AMP	18 LEVEL	If "Part1-4" is selected Level	<b>TONE COMMON EDIT:</b> Level	
		If "PartR" is selected Part Level	<b>SCENE PART EDIT:</b> Part Level	
ENV	19 PITCH	Select PITCH ENV (*2)	-	
	20 FILTER	Select FILTER ENV (*2)	-	
	21 AMP	Select AMP ENV (*2)	-	

Section	Controller	Parameter	Destination or operation when used with the [SHIFT] button
ENV	22 A	If "PITCH ENV" is selected Pit Attack	<b>SCENE PART EDIT:</b> <b>PITCH:</b> Pit Attack
		If "FILTER ENV" is selected Filt Attack	<b>SCENE PART EDIT:</b> <b>FILTER:</b> Filt Attack
	23 D	If "AMP ENV" is selected Amp Attack	<b>SCENE PART EDIT:</b> <b>AMP:</b> Amp Attack
		If "PITCH" is selected Pit Decay	<b>SCENE PART EDIT:</b> <b>PITCH:</b> Pit Decay
ENV	24 S	If "FILTER ENV" is selected Filt Decay	<b>SCENE PART EDIT:</b> <b>FILTER:</b> Filt Decay
		If "AMP ENV" is selected Amp Decay	<b>SCENE PART EDIT:</b> <b>AMP:</b> Amp Decay
	25 R	If "PITCH" is selected Pit Sustain	<b>SCENE PART EDIT:</b> <b>PITCH:</b> Pit Sustain
		If "FILTER ENV" is selected Filt Sustain	<b>SCENE PART EDIT:</b> <b>FILTER:</b> Filt Sustain
ENV	26 DEPTH	If "AMP ENV" is selected Amp Sustain	<b>SCENE PART EDIT:</b> <b>AMP:</b> Amp Sustain
		If "PITCH" is selected Pit Release	<b>SCENE PART EDIT:</b> <b>PITCH:</b> Pit Release
	26 DEPTH	If "FILTER ENV" is selected Filt Release	<b>SCENE PART EDIT:</b> <b>FILTER:</b> Filt Release
		If "AMP ENV" is selected Amp Release	<b>SCENE PART EDIT:</b> <b>AMP:</b> Amp Release
ENV	26 DEPTH	If "PITCH ENV" is selected Pit ENV Depth	<b>SCENE PART EDIT:</b> <b>PITCH:</b> Pit ENV Depth
		If "FILTER ENV" is selected Filt ENV Depth	<b>SCENE PART EDIT:</b> <b>FILTER:</b> Filt ENV Depth

Section	Controller	Parameter	Destination or operation when used with the [SHIFT] button
PART/FUNC	27 MONO	Mono Poly	<b>TONE COMMON EDIT:</b> Mono Poly
		<b>For VOCODER</b> Mono/Poly	<b>SCENE PART EDIT:</b> <b>CTRL:</b> Mono/Poly
	28 UNISON	Unison Sw	<b>TONE COMMON EDIT:</b> <b>Synth:</b> Unison Sw
		<b>For VOCODER</b> Unison Sw	<b>SCENE PART EDIT:</b> <b>CTRL:</b> Unison Sw
	29 OSC1 SELECT	Select PARTIAL1 (*3)	<b>TONE EDIT PARTIAL1:</b> <b>Tone PMT:</b> Ptl Sw
	30 OSC2 SELECT	Select PARTIAL2 (*3)	<b>TONE EDIT PARTIAL2:</b> <b>Tone PMT:</b> Ptl Sw
31 OSC3 SELECT	Select PARTIAL3 (*3)	<b>TONE EDIT PARTIAL3:</b> <b>Tone PMT:</b> Ptl Sw	
32 OSC4 SELECT	Select PARTIAL4 (*3)	<b>TONE EDIT PARTIAL4:</b> <b>Tone PMT:</b> Ptl Sw	

(\*1): The priority order for LFO type is PITCH > FILTER > AMP.

(\*2): The priority order for ENV type is AMP > PITCH > FILTER.

(\*3): Only enabled in "FUNC" mode.

\* For other parameters, refer to "Parameter Guide" (PDF).

XV-5080, RD-PIANO, and Other Tones (When the [MODEL BANK] Button Is Lit)

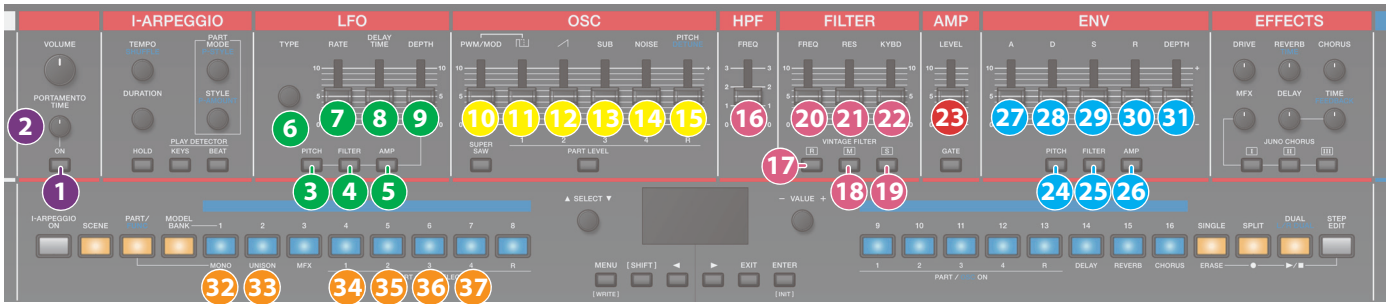

Section	Controller	Parameter	Operation when used with the [SHIFT] button
PORTAMENTO	1 ON	Porta Sw	<b>TONE COMMON EDIT:</b> Porta Sw
	2 TIME	Porta Time	<b>TONE COMMON EDIT:</b> Porta Time
LFO	3 PITCH	Select PITCH LFO (*1)	-
	4 FILTER	Select FILTER LFO (*1)	-
	5 AMP	Select AMP LFO (*1)	-
	6 TYPE	L1 Waveform	<b>TONE EDIT:</b> <b>LFO1:</b> L1 Waveform
	7 RATE	L1 Rate	<b>TONE EDIT:</b> <b>LFO1:</b> L1 Rate
LFO	8 DELAY TIME	L1 Fade Time	<b>TONE EDIT:</b> <b>LFO1:</b> L1 Fade Time
	9 DEPTH	<b>If "PITCH LFO" is selected</b> L1 Pit Depth	<b>TONE EDIT:</b> <b>LFO1:</b> L1 Pit Depth
		<b>If "FILTER LFO" is selected</b> L1 Flt Depth	<b>TONE EDIT:</b> <b>LFO1:</b> L1 Flt Depth
OSC	10 PWM/MOD	<b>If "AMP LFO" is selected</b> L1 Amp Depth	<b>TONE EDIT:</b> <b>LFO1:</b> L1 Amp Depth
		<b>If "MOD" is not selected</b> Fine Tune	<b>TONE EDIT:</b> <b>Tone PTL:</b> Fine Tune
		<b>If "SYNC" is selected</b> Fine Tune	<b>TONE EDIT:</b> <b>Tone PTL:</b> Fine Tune
	11 Π	<b>If "RING" is selected</b> Ring OSC2/4 Lv	<b>TONE COMMON EDIT:</b> <b>Synth PMT:</b> Ring OSC2/4 Lv
		<b>If "XMOD" is selected</b> XMd12 Dpth	<b>TONE COMMON EDIT:</b> <b>Synth PMT:</b> XMd12 Dpth
OSC	12 Π	Partial1 Level	<b>TONE EDIT PARTIAL1:</b> <b>Tone PTL:</b> Level
	13 /	Partial2 Level	<b>TONE EDIT PARTIAL2:</b> <b>Tone PTL:</b> Level
	14 SUB	Partial3 Level	<b>TONE EDIT PARTIAL3:</b> <b>Tone PTL:</b> Level
	15 NOISE	Partial4 Level	<b>TONE EDIT PARTIAL4:</b> <b>Tone PTL:</b> Level
	15 PITCH	Coarse Tune	<b>TONE EDIT:</b> <b>Tone PTL:</b> Coarse Tune
HPF	16 FREQ	HPF Cutoff	<b>TONE EDIT:</b> <b>Synth PTL:</b> HPF Cutoff
FILTER	17 [R]		
	18 [M]	Select VCF TYPE	<b>TONE EDIT: Synth PTL:</b> VCF Type
	19 [S]		
	20 FREQ	Cutoff	<b>TONE EDIT: Tone PTL:</b> Cutoff
	21 RES	Resonance	<b>TONE EDIT: Tone PTL:</b> Resonance
	22 KYBD	Cutoff Keyf	<b>TONE EDIT: Tone PTL:</b> Cutoff Keyf

Section	Controller	Parameter	Operation when used with the [SHIFT] button
AMP	23 LEVEL	<b>If "Part1-4" is selected</b> Level	<b>TONE COMMON EDIT:</b> Level
		<b>If "Part5" is selected</b> Part Level	<b>SCENE PART EDIT:</b> Part Level
	24 PITCH	Select PITCH ENV (*2)	-
ENV	25 FILTER	Select FILTER ENV (*2)	-
	26 AMP	Select AMP ENV (*2)	-
	27 A	<b>If "PITCH ENV" is selected</b> Pit Time1	<b>TONE EDIT:</b> <b>Pitch Env:</b> Pit Time1
		<b>If "FILTER ENV" is selected</b> Filtr Time1	<b>TONE EDIT:</b> <b>Filter Env:</b> Filtr Time1
		<b>If "AMP ENV" is selected</b> Amp Time1	<b>TONE EDIT:</b> <b>Amp Env:</b> Amp Time1
	28 D	<b>If "PITCH ENV" is selected</b> Pit Time3	<b>TONE EDIT:</b> <b>Pitch Env:</b> Pit Time3
		<b>If "FILTER ENV" is selected</b> Filtr Time3	<b>TONE EDIT:</b> <b>Filter Env:</b> Filtr Time3
		<b>If "AMP ENV" is selected</b> Amp Time3	<b>TONE EDIT:</b> <b>Amp Env:</b> Amp Time3
	29 S	<b>If "PITCH ENV" is selected</b> Pit Lv3	<b>TONE EDIT:</b> <b>Pitch Env:</b> Pit Lv3
		<b>If "FILTER ENV" is selected</b> Filtr Lv3	<b>TONE EDIT:</b> <b>Filter Env:</b> Filtr Lv3
<b>If "AMP ENV" is selected</b> Amp Lv3		<b>TONE EDIT:</b> <b>Amp Env:</b> Amp Lv3	
30 R	<b>If "PITCH ENV" is selected</b> Pit Time4	<b>TONE EDIT:</b> <b>Pitch Env:</b> Pit Time4	
	<b>If "FILTER ENV" is selected</b> Filtr Time4	<b>TONE EDIT:</b> <b>Filter Env:</b> Filtr Time4	
31 DEPTH	<b>If "AMP ENV" is selected</b> Amp Time4	<b>TONE EDIT:</b> <b>Amp Env:</b> Amp Time4	
	<b>If "PITCH ENV" is selected</b> Pit Depth	<b>TONE EDIT:</b> <b>Pitch Env:</b> Pit Depth	
		<b>If "FILTER ENV" is selected</b> Filtr Depth	<b>TONE EDIT:</b> <b>Filter Env:</b> Filtr Depth

Section	Controller	Parameter	Operation when used with the [SHIFT] button
PART/FUNC	32 MONO	Mono Poly	<b>tone COMMON EDIT:</b> Mono Poly
		<b>For VOCODER</b> Mono/Poly	<b>SCENE PART EDIT:</b> <b>CTRL:</b> Mono/Poly
	33 UNISON	Unison Sw	<b>tone COMMON EDIT:</b> <b>Synth:</b> Unison Sw
		<b>For VOCODER</b> Unison Sw	<b>SCENE PART EDIT:</b> <b>CTRL:</b> Unison Sw
	34 OSC1 SELECT	Select PARTIAL1 (*3)	<b>tone EDIT PARTIAL1:</b> <b>tone PMT:</b> Ptl Sw
	35 OSC2 SELECT	Select PARTIAL2 (*3)	<b>tone EDIT PARTIAL2:</b> <b>tone PMT:</b> Ptl Sw
	36 OSC3 SELECT	Select PARTIAL3 (*3)	<b>tone EDIT PARTIAL3:</b> <b>tone PMT:</b> Ptl Sw
37 OSC4 SELECT	Select PARTIAL4 (*3)	<b>tone EDIT PARTIAL4:</b> <b>tone PMT:</b> Ptl Sw	

(\*1): The priority order for LFO type is PITCH > FILTER > AMP.

(\*2): The priority order for ENV type is AMP > PITCH > FILTER.

(\*3): Only enabled in "FUNC" mode.

\* For other parameters, refer to "Parameter Guide" (PDF).

## Controllers Common to All Models

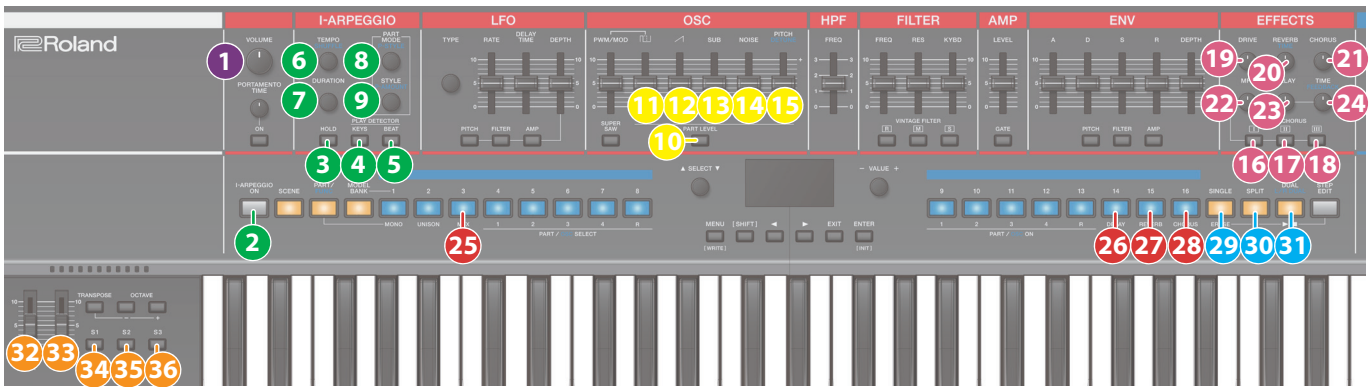

Section	Controller	Parameter	Operation when used with the [SHIFT] button (*1)
VOLUME	1	VOLUME	VOLUME
I-ARPEGGIO	2	I-ARPEGGIO ON	Arp Switch
	3	HOLD	Hold Sw <b>ARP COMMON EDIT:</b> Hold Sw
	4	KEYS	Keys Sw <b>ARP COMMON EDIT:</b> Keys Sw
	5	BEAT	Beat Sw <b>ARP COMMON EDIT:</b> Beat Sw
	6	TEMPO	Tempo <b>If SYSTEM:TempoSrc is "SCENE"</b> <b>SCENE COMMON EDIT:</b> Tempo <b>If SYSTEM:TempoSrc is "SYS"</b> <b>SYSTEM:</b> TEMPO/SYNC: Tempo
		SHUFFLE	G-Shuffle (*2) <b>ARP COMMON EDIT:</b> G-Shuffle
	7	DURATION	G-Duration <b>ARP COMMON EDIT:</b> G-Duration
		MOTIF	Motif (*2) <b>ARP PART EDIT:</b> Motif
	8	MODE	Arp Mode <b>ARP PART EDIT:</b> Arp Mode
		P-STYLE	Probability Style (*2) <b>ARP PART EDIT:</b> Probability: Style
OSC	9	STYLE	I-Arp Style <b>If ARP PART EDIT: Arp Mode is "ARP"</b> <b>ARP PART EDIT:</b> I-Arp Style Arp Style <b>If ARP PART EDIT: Arp Mode is "I-ARP"</b> <b>ARP PART EDIT:</b> Arp Style
	10	PART LEVEL	Select PART LEVEL
	11	[L]	<b>If "PART LEVEL" is selected</b> [PART LEVEL] button
	12	[/]	<b>If "PART LEVEL" is selected</b> Part2 Level
	13	SUB	<b>If "PART LEVEL" is selected</b> Part3 Level <b>SCENE PART EDIT:</b> Part Level
	14	NOISE	<b>If "PART LEVEL" is selected</b> Part4 Level
	15	PITCH	<b>If "PART LEVEL" is selected</b> PartR Level

Section	Controller	Parameter	Operation when used with the [SHIFT] button (*1)	
EFFECTS	16	[I]	JUNO Chorus Mode I <b>If SCENE PART MFX: FilwToneMFX is "ON"</b> <b>SCENE PART MFX:</b> Type	
		17	[II]	JUNO Chorus Mode II <b>If SCENE PART MFX: FilwToneMFX is "ON"</b> <b>SCENE PART MFX:</b> Type
		18	[III]	JUNO Chorus Mode III <b>If SCENE PART MFX: FilwToneMFX is "ON"</b> <b>SCENE PART MFX:</b> Type
	19	DRIVE	Drive <b>SCENE EFFECT:</b> OD: Drive	
		20	REVERB	<b>If SCENE PART EDIT: Output is "THRU"</b> Rev Send <b>SCENE PART EDIT:</b> Rev Send <b>If SCENE PART EDIT: Output is "DRIVE"</b> Ren Send Lev <b>SCENE EFFECT:</b> OD: Rev Send Lev
		21	CHORUS	<b>If SYSTEM EFFECT: Rev: Source is "SYS"</b> Time (*2) <b>SYSTEM EFFECT:</b> Rev: Time <b>If SYSTEM EFFECT: Rev: Source is "SCENE"</b> Time (*2) <b>SCENE EFFECT:</b> Rev: Time <b>If SCENE PART EDIT: Output is "THRU"</b> Cho Send <b>SCENE PART EDIT:</b> Cho Send <b>If SCENE PART EDIT: Output is "DRIVE"</b> Cho Send Lev <b>SCENE EFFECT:</b> OD: Cho Send Lev

Section	Controller	Parameter	Operation when used with the [SHIFT] button (*1)	
EFFECTS	22	MFX	Assign Parameters (*3)	If SCENE PART: MFX; FilwToneMFX is ON Parameter corresponding to "TONE MFX" (*4)
				If SCENE PART: MFX; FilwToneMFX is OFF Parameter corresponding to "SCENE PART MFX" (*4)
	23	DELAY	Dly Send	If SCENE PART: EDIT: Output is THRU? Dly Send <b>SCENE PART EDIT:</b> Dly Send
				If SCENE PART: EDIT: Output is DRIVE? Dly Send Lev <b>SCENE EFFECT:</b> OD: Dly Send Lev
	24	TIME	Dly Note	If SYSTEM EFFECT: Dly; Source is SYS; and Dly Sync is OFF? Dly Msec <b>SYSTEM EFFECT:</b> Dly: Dly Msec
				If SYSTEM EFFECT: Dly; Source is SYS; and Dly Sync is ON? Dly Note <b>SYSTEM EFFECT:</b> Dly: Dly Note
				If SYSTEM EFFECT: Dly; Source is SCENE; and Dly Sync is OFF? Dly Msec <b>SCENE EFFECT:</b> Dly: Dly Msec
				If SYSTEM EFFECT: Dly; Source is SCENE; and Dly Sync is ON? Dly Note <b>SCENE EFFECT:</b> Dly: Dly Note
	FEEDBACK	Feedback (*2)	If SYSTEM EFFECT: Dly; Source is SYS? <b>SYSTEM EFFECT:</b> Dly: Feedback	
			If SYSTEM EFFECT: Dly; Source is SCENE? <b>SCENE EFFECT:</b> Dly: Feedback	
PART/FUNC	25	MFX	MFX Switch	If SCENE PART: MFX; FilwToneMFX is ON? <b>TONE MFX:</b> Switch
				If SCENE PART: MFX; FilwToneMFX is OFF? <b>SCENE PART MFX:</b> Switch
	26	DELAY	Delay Switch	If SYSTEM EFFECT: Dly; Source is SCENE? <b>SCENE EFFECT:</b> Dly: Switch
				If SYSTEM EFFECT: Dly; Source is SYS? <b>SYSTEM EFFECT:</b> Dly: Switch
	27	REVERB	Reverb Switch	If SYSTEM EFFECT: Rev; Source is SCENE? <b>SCENE EFFECT:</b> Rev: Switch
If SYSTEM EFFECT: Rev; Source is SYS? <b>SYSTEM EFFECT:</b> Rev: Switch				
28	CHORUS	Chorus Switch	If SYSTEM EFFECT: Cho; Source is SCENE? <b>SCENE EFFECT:</b> Cho: Switch	
			If SYSTEM EFFECT: Cho; Source is SYS? <b>SYSTEM EFFECT:</b> Cho: Switch	
KEY MODE	29	SINGLE	SINGLE	-
	30	SPLIT	SPLIT	-
	31	DUAL L/R DUAL	DUAL L/R DUAL (*2)	-

Section	Controller	Parameter	Operation when used with the [SHIFT] button (*1)
CTRL	32	SL1	Assigned function (*4) <b>SCENE COMMON EDIT:</b> ASSIGN: SL1
	33	SL2	Assigned function (*4) <b>SCENE COMMON EDIT:</b> ASSIGN: SL2
	34	S1	Assigned function (*4) <b>SCENE COMMON EDIT:</b> ASSIGN: S1 Func
	35	S2	Assigned function (*4) <b>SCENE COMMON EDIT:</b> ASSIGN: S2 Func
	36	S3	Assigned function (*4) <b>SCENE COMMON EDIT:</b> ASSIGN: S3 Func

(\*1): For parameters whose function can be assigned, the factory-set destination is listed. If the system parameter "Source" setting of a controller is set to "SYSTEM," you'll move to the corresponding SYSTEM parameter.  
→ "Parameter Guide" (PDF)

(\*2): Only enabled in "FUNC" mode.

(\*3): The corresponding parameter differs depending on the Type of MFX.  
→ "MFX Assign Parameters" (p. 36)

(\*4): The functions that can be assigned differ depending on the controller.  
→ "List of functions that can be assigned to the controllers" (p. 41)

## MFX Assign Parameters

MFX Type	Condition	Assign Parameter
Thru		Not used.
Equalizer		Low Gain
Mid-Side EQ		M HighG
Spectrum		Band1
Isolator		High Level
Low Boost		Boost Gain
SuperFilter		Cutoff
MM Filter		Tone
Step Filter		Reso
Enhancer		Sens
Exciter		Level
Auto Wah		Depth
Humanizer	Rate Sync=OFF	Rate
	Rate Sync=ON	Rate Note
Phaser	Rate Sync=OFF	Rate
	Rate Sync=ON	Rate Note
Small Phaser		Rate
Script 90		Speed
Script 100	Rate Sync=OFF	Rate
	Rate Sync=ON	Rate Note
Step Phaser	Rate Sync=OFF	Rate
	Rate Sync=ON	Rate Note
M StagePhsr	Rate Sync=OFF	Rate
	Rate Sync=ON	Rate Note
Inf Phaser		Speed
Flanger		Depth
SBF-325		Depth
StepFlanger		Depth
Chorus		Depth
Hexa-Chorus		Depth
Trem Chorus	Trm Sync=OFF	T.Rate
	Trm Sync=ON	T.Rate Nt
Space-D		Depth
CE-1		Intensity
SDD-320		Mode
JUNO Chorus		Noise Lv
Ring Mod		Frequency
Tremolo		Depth
Auto Pan	Rate Sync=OFF	Rate
	Rate Sync=ON	Rate Note
Slicer		Attack
Rotary		Speed
VK Rotary		Speed
Overdrive		Drive
Distortion		Drive
T-Scream		Distortion
Fuzz		Drive
Fattener		Even Level
HMS Distort		Dist
Saturator		Balance
W Saturator		Drive
Gt Amp Sim		Drive
EP Amp Sim	Speed Sync=OFF	Speed
	Speed Sync=ON	Speed Nt
Speaker Sim		Direct Lv
Compressor		Attack
M/S Comp		M Thres
Limiter		Threshold
Sustainer		Sustain
Transient		Release
Gate		Threshold

MFX Type	Condition	Assign Parameter
Delay		Balance
Mod Delay		Balance
2Tap PanDly		Balance
3Tap PanDly		Balance
4Tap PanDly		Balance
MultiTapDly		Balance
Reverse Dly		Balance
TimeCtrlDly	Delay Sync=OFF	D.Time
	Delay Sync=ON	D.Time Nt
Tape Echo		Intensity
M/S Delay		MD Level
DJFX Looper		Loop Sw
BPM Looper		Length
LOFI Comp		Balance
Bit Crusher		Sample Rate
Phonograph		Balance
PitchShiftr		Coarse
2V PShifter		P2Coarse
OD->Chorus	Cho Sync=OFF	C.Rate
	Cho Sync=ON	C.Rate Nt
OD->Flanger	Flg Sync=OFF	F.Rate
	Flg Sync=ON	F.Rate Nt
OD->Delay		Dly Bal
DS->Chorus	Cho Sync=OFF	C.Rate
	Cho Sync=ON	C.Rate Nt
DS->Flanger	Flg Sync=OFF	F.Rate
	Flg Sync=ON	F.Rate Nt
DS->Delay		Dly Bal
OD/DS>T.Wah		TWah Sens
OD/DS>A.Wah	AWah Sync=OFF	AWRate
	AWah Sync=ON	AWRate Nt
Gt->Chorus		C.Rate
Gt->Flanger		F.Rate
Gt->Phaser		P.Rate
Gt->Delay		Dly Bal
EP->Tremolo	Tremolo Sync=OFF	T.Speed
	Tremolo Sync=ON	T.Spd Nt
EP->Chorus		Cho Depth
EP->Flanger		Flg Depth
EP->Phaser		Phs Depth
EP->Delay		Dly Bal
Enhncr->Cho	Cho Sync=OFF	C.Rate
	Cho Sync=ON	C.Rate Nt
Enhncr->Fl	Flg Sync=OFF	F.Rate
	Flg Sync=ON	F.Rate Nt
Enhncr->Dly		Dly Bal
Chorus->Dly		Dly Bal
Flanger>Dly		Dly Bal
Chorus->Fl	Flg Sync=OFF	F.Rate
	Flg Sync=ON	F.Rate Nt
JD-Multi		PH Mix



# Using the Bluetooth® Functionality

## Using the Speakers of the JUNO-X to Play Music from a Mobile Device

You can connect a mobile device such as a smartphone or tablet to this instrument via Bluetooth and play the songs stored on your mobile device from this instrument.

## Registering a Mobile Device with This Instrument (Pairing)

In order to connect your mobile device wirelessly to this instrument via Bluetooth, you must “pair” them by registering this instrument on your mobile device so that the two devices can authenticate with each other. As an example, we explain how to make settings for an iPhone.

### MEMO

- Once a mobile device has been paired with this instrument, there is no need to perform pairing again. If you want to connect this instrument with a mobile device that has already been paired, refer to “Connecting an Already-Paired Mobile Device” (p. 37).
- Pairing is required again if you execute a factory reset (p. 48).

### 1. Place the mobile device that you want to connect nearby this instrument.

### 2. Press the [MENU] (WRITE) button.

The MENU screen appears.

### 3. Use the [▲SELECT▼] knob to select “SYSTEM.”

### 4. Press the [ENTER] (INIT) button.

The SYSTEM screen appears.

### 5. Use the [▲SELECT▼] knob to select “Bluetooth Sw,” and use the [- VALUE +] knob to specify “ON.”

### 6. Use the [▲SELECT▼] knob to select “Pairing,” and then press the [ENTER] (INIT) button.

The display indicates “PAIRING...,” and this instrument waits for a response from the mobile device.

### 7. Turn on the Bluetooth function of the mobile device.

### 8. Tap “JUNO-X AUDIO,” shown on the Bluetooth device screen of your mobile device.

This instrument is paired with the mobile device. If the pairing is successful, the message “Connected” is shown on the screen of this instrument.

## Connecting an Already-Paired Mobile Device

### 1. Turn on the Bluetooth function of the mobile device.

### 2. Turn on the JUNO-X’s Bluetooth function.

2-1. Press the [MENU] (WRITE) button.

2-2. Use the [▲SELECT▼] knob to select “SYSTEM,” and then press the [ENTER] (INIT) button.

2-3. Use the [▲SELECT▼] knob to select “Bluetooth Sw,” and use the [- VALUE +] knob to specify “ON.”

### MEMO

- If you were unable to establish a connection using the procedure above, tap “JUNO-X AUDIO” that is displayed in the Bluetooth device screen of the mobile device.
- To disconnect Bluetooth, either turn this instrument’s Bluetooth function “OFF” (SYSTEM parameter → turn “Bluetooth Sw” OFF) or turn the mobile device’s Bluetooth function off.

## Playing Music from a Mobile Device

### 1. Connect your mobile device via Bluetooth.

### 2. On the mobile device, use a music app to play back music.

The sound is heard from the JUNO-X.

\* To adjust the playback volume, adjust the volume on your mobile device or adjust the System setting “AuxIn/BT InLev.”

## Using Apps That Support Bluetooth MIDI

You can also use apps with this instrument that are compatible with Bluetooth MIDI (such as GarageBand).

### 1. Place the mobile device that you want to connect nearby this instrument.

### 2. Press the [MENU] (WRITE) button.

The MENU screen appears.

### 3. Use the [▲SELECT▼] knob to select “SYSTEM.”

### 4. Press the [ENTER] (INIT) button.

The SYSTEM screen appears.

### 5. Use the [▲SELECT▼] knob to select “Bluetooth Sw,” and use the [- VALUE +] knob to specify “ON.”

### 6. Turn on the Bluetooth function of the mobile device.

### 7. In the app installed on your mobile device (e.g., GarageBand), pair with this instrument.

### NOTE

In the Bluetooth MIDI Device settings of the app (not the Bluetooth settings of your mobile device), tap “JUNO-X MIDI” to pair.

## Differentiating Multiple JUNO-X Units (Bluetooth ID)

If you are pairing with your mobile device in a place where there is more than one JUNO-X, you can assign a device ID (an identifying number) for each one. When you specify a device ID, the specified number is added to the end of the device name that appears on your mobile device.

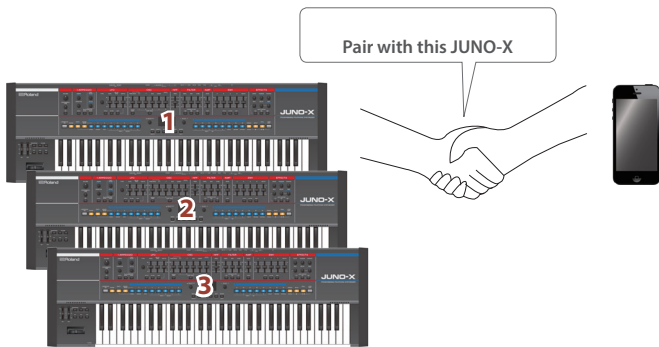

- 1. Press the [MENU] (WRITE) button.**  
The MENU screen appears.
- 2. Use the [▲SELECT▼] knob to select "SYSTEM," and then press the [ENTER] (INIT) button.**
- 3. Use the [▲SELECT▼] knob to select "Bluetooth ID."**
- 4. Use the [- VALUE +] knob to change the value.**

Parameter [▲SELECT▼] knob	Value [- SELECT +] knob	Explanation
Bluetooth ID	OFF, 1-9	Specifies the number added to the end of this unit's device name shown in a Bluetooth-connected app.
	Set to "OFF"	"JUNO-X Audio," "JUNO-X MIDI" (default value)
	Set to "1"	"JUNO-X Audio 1," "JUNO-X MIDI 1"

- 5. To save the settings, hold down the [SHIFT] button and press the [MENU] (WRITE) button.**  
A confirmation message appears.  
If you decide to cancel, press the [EXIT] button.
- 6. To execute, press the [ENTER] (INIT) button.**

# Control

## Connecting a Computer

Audio and MIDI data can be exchanged with a computer via the USB COMPUTER port on this instrument.

### MEMO

For details on operating requirements and supported operating systems, refer to the Roland website.



## Installing the Dedicated Driver

In order to use the JUNO-X, you'll need to download the driver from the following URL and install it on your computer.

For details on installation, refer to the Roland website.

<https://www.roland.com/support/>

## USB driver settings

Here's how to specify the USB driver that's used when connecting to your computer via the USB COMPUTER port.

\* Changes to the USB driver setting take effect when this instrument restarts.

1. Press the [MENU] (WRITE) button.  
The MENU screen appears.
2. Use the [▲SELECT▼] knob to select "SYSTEM," and then press the [ENTER] (INIT) button.
3. Use the [▲SELECT▼] knob to select "USB Driver."
4. Use the [- VALUE +] knob to specify "VENDOR."

Parameter [▲SELECT▼] knob	Value [- VALUE +] knob	Explanation
USB Driver	VENDOR	Choose this when using the USB driver that you downloaded from the Roland website.
	GENERIC	Choose this when using the USB driver that was provided with your computer. * Only MIDI can be used.

5. To save the settings, hold down the [SHIFT] button and press the [MENU] (WRITE) button.  
A confirmation message appears.  
If you decide to cancel, press the [EXIT] button.
6. To execute, press the [ENTER] (INIT) button.

## Port names when using the VENDOR driver

### Audio input device

Device Name	Port Name
JUNO-X	IN MIX (mixed output of the JUNO-X)
	IN 1 (output of the JUNO-X's part 1)
	IN 2 (output of the JUNO-X's part 2)
	IN 3 (output of the JUNO-X's part 3)
	IN 4 (output of the JUNO-X's part 4)
	IN 5 (output of the JUNO-X's part R)
	IN MIC (output of the signal that is input from the JUNO-X's MIC IN jack)

### Audio output device

Device Name	Port Name
JUNO-X	OUT (USB audio input to the JUNO-X)
	OUT MIC (treated as mic input to the JUNO-X)

### MIDI input/output device

MIDI IN	JUNO-X
	JUNO-X DAW CTRL
MIDI OUT	JUNO-X
	JUNO-X DAW CTRL

\* DAW CTRL is not used for normal MIDI communication.

## Using USB Audio

Using the USB driver allows the unit to exchange audio data with a computer.

For details on how to make settings for your computer, refer to "Readme.htm" which is in the driver file that you downloaded from the Roland support page.

<https://www.roland.com/support/>

### NOTE

Before using USB audio, be sure to make settings so that the USB audio input/output is not excessively loud.

## Adjusting the USB audio input

From your computer or other USB-connected device, adjust the volume of the audio that is input to the JUNO-X.

1. Press the [MENU] (WRITE) button.  
The MENU screen appears.
2. Use the [▲SELECT▼] knob to select "SYSTEM," and then press the [ENTER] (INIT) button.
3. Use the [▲SELECT▼] knob to select "USB In Lev."
4. Use the [- VALUE +] knob to adjust the volume.
5. To save the settings, hold down the [SHIFT] button and press the [MENU] (WRITE) button.  
A confirmation message appears.  
If you decide to cancel, press the [EXIT] button.
6. To execute, press the [ENTER] (INIT) button.

## Adjusting the USB audio output

Here's how to adjust the volume of the audio that is output from the JUNO-X to a computer or other USB-connected device.

### 1. Press the [MENU] (WRITE) button.

The MENU screen appears.

### 2. Use the [▲SELECT▼] knob to select "SYSTEM," and then press the [ENTER] (INIT) button.

### 3. Use the [▲SELECT▼] knob to select "USB Out Lev."

### 4. Use the [- VALUE +] knob to adjust the volume.

### 5. To save the settings, hold down the [SHIFT] button and press the [MENU] (WRITE) button.

A confirmation message appears.

If you decide to cancel, press the [EXIT] button.

### 6. To execute, press the [ENTER] (INIT) button.

## Controlling MainStage (DAW CTRL Function)

You can use the knobs, buttons and sliders of the JUNO-X to control Apple's MainStage application (using the DAW CTRL function).

In order to use this function, you'll need to install the dedicated "MainStage profile" in addition to the USB driver.

\* For details on how to install the profile and use the DAW CTRL function, refer to "MainStage Profile Usage Guide" (PDF).

Controller	Function
[PART/FUNC] button + [MENU] (WRITE) button	Switch the JUNO-X to DAW CTRL mode.
[EXIT] button	Exit DAW CTRL mode and return to the normal state.
[▲SELECT▼] knob	Set Select Change the set.
[▶] button	Next Set Recall the next set.
[◀] button	Previous Set Recall the previous set.
[- VALUE +] knob	Patch Select Change the patch.
[AMP LEVEL] knob	Volume Adjusts the master volume.
[LFO RATE] slider	Smart Control Edit the Smart Control parameters.
[LFO DELAY TIME] slider	
[LFO DEPTH] slider	
[PWM/MOD] slider	
[□] slider	
[ / ] slider	
[SUB] slider	
[NOISE] slider	

## Connecting External Devices

### Controlling an External MIDI Device

MIDI messages can be sent from the MIDI OUT connector and from USB MIDI OUT when you operate the controllers of the JUNO-X, such as the knobs and keyboard, and the various pedals connected to the rear panel.

### Specifying the MIDI channel

#### 1. Press the [SCENE] button.

#### 2. Press the [▶] button twice to access the scene part edit screen.

#### 3. Use the [▲SELECT▼] knob to select "Rx Ch," and use the [- VALUE +] knob to set the channel.

#### 4. If you want to save the setting, execute the Scene Write operation.

##### 4-1. Hold down the [SHIFT] button and press the [MENU] (WRITE) button.

The WRITE MENU screen appears.

##### 4-2. Use the [▲SELECT▼] knob to select "SCENE," and then press the [ENTER] (INIT) button.

##### 4-3. Use the [▲SELECT▼] knob and the [- VALUE +] knob to select the save-destination, and then press the [ENTER] (INIT) button.

If you want to rename the scene that's being saved, use the [◀] [▶] buttons to move the cursor and use the [- VALUE +] knob to specify characters.

##### 4-4. Press the [ENTER] (INIT) button.

##### 4-5. To execute, press the [ENTER] (INIT) button.

### Specifying the MIDI output

#### 1. Press the [MENU] (WRITE) button.

#### 2. Use the [▲SELECT▼] knob to select "SYSTEM," and then press the [ENTER] (INIT) button.

#### 3. Use the [▲SELECT▼] knob to select "MIDI Tx" for the parameter that you want to output, and use the [- VALUE +] knob to specify "ON."

For details, refer to "Parameter Guide" (PDF).

#### 4. To save the settings, hold down the [SHIFT] button and press the [MENU] (WRITE) button.

A confirmation message appears.

If you decide to cancel, press the [EXIT] button.

#### 5. To execute, press the [ENTER] (INIT) button.

## Using the AIRA LINK Function

AIRA LINK (\*) lets you connect the AIRA MIXER MX-1 (sold separately) and this instrument via a single USB cable. This is an easy way to enjoy synchronized performances using I-ARPEGGIO.

### (\*) What is AIRA LINK?

AIRA LINK is a feature that lets you exchange audio/MIDI data between compatible devices using a single USB cable, such as the AIRA-series MX-1 digital mixer and the JUNO-X.

### NOTE

In order to use this function, the SYSTEM parameter USB Driver must be set to "VENDOR."

→ "USB driver settings" (p. 39)

## Settings on the JUNO-X

1. Press the [MENU] (WRITE) button.
2. Use the [▲SELECT▼] knob to select "SYSTEM," and then press the [ENTER] (INIT) button.
3. Use the [▲SELECT▼] knob to select "Sync Mode," and use the [- VALUE +] knob to specify either "AUTO" or "USB COM."
4. To save the settings, hold down the [SHIFT] button and press the [MENU] (WRITE) button.  
A confirmation message appears.  
If you decide to cancel, press the [EXIT] button.
5. To execute, press the [ENTER] (INIT) button.

## Using I-ARPEGGIO Sync Mode

Specifies the synchronization setting for arpeggio performance when connected to an external device and playing in synchronization.

1. Press the [MENU] (WRITE) button.
2. Use the [▲SELECT▼] knob to select "SYSTEM," and then press the [ENTER] (INIT) button.
3. Use the [▲SELECT▼] knob to select "Arp Sync," and use the [- VALUE +] knob to specify either "BEAT" or "MEASURE."

**BEAT:** The arpeggio plays in synchronization with the beat.

**MEASURE:** The arpeggio plays in synchronization with the measure.

4. To save the settings, hold down the [SHIFT] button and press the [MENU] (WRITE) button.  
A confirmation message appears.  
If you decide to cancel, press the [EXIT] button.
5. To execute, press the [ENTER] (INIT) button.

## Controlling from an External Device

You can operate the JUNO-X via the MIDI IN connector, USB MIDI IN port, or by using controllers such as a damper pedal etc. connected to the rear panel.

1. Press the [MENU] (WRITE) button.
2. Use the [▲SELECT▼] knob to select "SYSTEM," and then press the [ENTER] (INIT) button.

3. Use the [▲SELECT▼] knob to select the "BUTTON FUNC," "SLIDER FUNC" and "PEDAL FUNC" parameters, and use the [- VALUE +] knob to edit the value.

→ "List of functions that can be assigned to the controllers" (p. 41)

4. To save the settings, hold down the [SHIFT] button and press the [MENU] (WRITE) button.

A confirmation message appears.

If you decide to cancel, press the [EXIT] button.

5. To execute, press the [ENTER] (INIT) button.

## List of functions that can be assigned to the controllers

Function	S1 Func S2 Func S3 Func	SL1 Func SL2 Func	HOLD Func	CTRL Func
OFF	✓	✓	✓	✓
CC01-31, 32 (OFF), 33-95	✓	✓	✓	✓
AFTERTOUCH	✓	✓	✓	✓
MONO/POLY	✓		✓	
SCENE DOWN *	✓		✓	
SCENE UP *	✓		✓	
TONE DOWN *	✓		✓	
TONE UP *	✓		✓	
PANEL DEC *	✓		✓	
PANEL INC *	✓		✓	
CHO SW	✓		✓	
REV SW	✓		✓	
DLY SW	✓		✓	
ARP SW *	✓		✓	
ARP HOLD *	✓		✓	
DETECT KEYS *	✓		✓	
DETECT BEAT *	✓		✓	
UNISON SW	✓		✓	
BEND MODE	✓		✓	
AUTO TUNING *	✓		✓	
TAP TEMPO *	✓		✓	
START/STOP *	✓		✓	
DRV SW	✓		✓	
VOC/MIC	✓		✓	
BEND DOWN		✓		✓
BEND UP		✓		✓
CHO LEVEL		✓		✓
REV LEVEL		✓		✓
DLY LEVEL		✓		✓
ARP SHUFFLE		✓		✓
ARP DURATION		✓		✓
PART FADE1		✓		✓
PART FADE2		✓		✓
LEVEL P-1		✓		✓
LEVEL P-2		✓		✓
LEVEL P-3		✓		✓
LEVEL P-4		✓		✓
LEVEL P-R		✓		✓
AGE		✓		✓

### MEMO

Functions marked by "\*" operate only in Latch mode. They do not operate in Momentary mode.

# Settings for the Entire Unit

## Accessing the MENU Screen

1. Press the [MENU] (WRITE) button.
2. Use the [▲SELECT▼] knob to select the parameter you wish to set, and then press the [ENTER] (INIT) button.
3. Use the [▲SELECT▼] knob to select the parameter, and use the [- VALUE +] knob to change the value.

## Editing the Scene Settings (SCENE EDIT)

1. Press the [MENU] (WRITE) button.
2. Use the [▲SELECT▼] knob to select "SCENE EDIT," and then press the [ENTER] (INIT) button.

The SCENE COMMON EDIT screen appears.

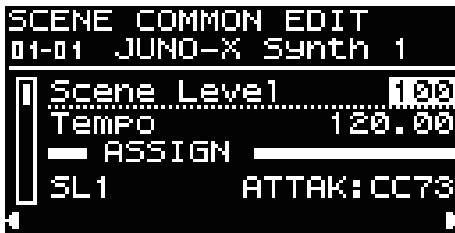

This is the same screen as when you press the [▶] button once from the SCENE TOP screen.

To edit other scene settings, press the [▶] button several times.

3. Use the [▲SELECT▼] knob to select the parameter, and use the [- VALUE +] knob to change the value.
4. If you want to save the setting, execute the Scene Write operation.
  - 4-1. Hold down the [SHIFT] button and press the [MENU] (WRITE) button.  
The WRITE MENU screen appears.
  - 4-2. Use the [▲SELECT▼] knob to select "SCENE," and then press the [ENTER] (INIT) button.
  - 4-3. Use the [▲SELECT▼] knob and the [- VALUE +] knob to select the save-destination, and then press the [ENTER] (INIT) button.  
If you want to rename the scene that's being saved, use the [◀] [▶] buttons to move the cursor and use the [- VALUE +] knob to specify characters.
  - 4-4. Press the [ENTER] (INIT) button.
  - 4-5. To execute, press the [ENTER] (INIT) button.

## Editing the I-ARPEGGIO Settings (ARPEGGIO EDIT)

1. Press the [MENU] (WRITE) button.
2. Use the [▲SELECT▼] knob to select "ARPEGGIO EDIT," and then press the [ENTER] (INIT) button.

The ARPEGGIO PART EDIT screen appears.



This is the same screen as when you press the [◀] button twice from the SCENE TOP screen.

Use the [PART/FUNC] button to select the part whose arpeggio parameters you want to edit, and then edit the parameters.

If you want to edit the ARPEGGIO COMMON EDIT settings, press the [▶] button once.

3. Use the [▲SELECT▼] knob to select the parameter, and use the [- VALUE +] knob to change the value.
4. If you want to save the setting, execute the Scene Write operation.
  - 4-1. Hold down the [SHIFT] button and press the [MENU] (WRITE) button.  
The WRITE MENU screen appears.
  - 4-2. Use the [▲SELECT▼] knob to select "SCENE," and then press the [ENTER] (INIT) button.
  - 4-3. Use the [▲SELECT▼] knob and the [- VALUE +] knob to select the save-destination, and then press the [ENTER] (INIT) button.  
If you want to rename the scene that's being saved, use the [◀] [▶] buttons to move the cursor and use the [- VALUE +] knob to specify characters.
  - 4-4. Press the [ENTER] (INIT) button.
  - 4-5. To execute, press the [ENTER] (INIT) button.

## Editing the Tone Settings (TONE EDIT)

1. Press the [MENU] (WRITE) button.
2. Use the [▲SELECT▼] knob to select "TONE EDIT," and then press the [ENTER] (INIT) button.

The TONE COMMON EDIT screen appears.

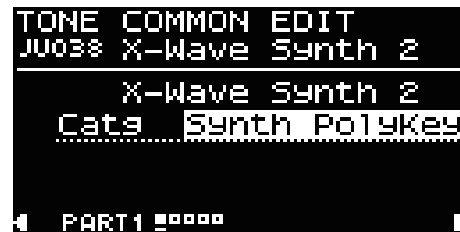

This is the same screen as when you press the [▶] button once from the MODEL BANK screen.

To edit other tone settings, press the [▶] button several times.

3. Use the [▲SELECT▼] knob to select the parameter, and use the [- VALUE +] knob to change the value.
4. If you want to save the setting, execute the Tone Write operation.
  - 4-1. Hold down the [SHIFT] button and press the [MENU] (WRITE) button.  
The WRITE MENU screen appears.
  - 4-2. Use the [▲SELECT▼] knob to select the part where the tone you want to save is assigned, and then press the [ENTER] (INIT) button.
  - 4-3. Use the [▲SELECT▼] knob and the [- VALUE +] knob to select the save-destination, and then press the [ENTER] (INIT) button.  
If you want to rename the tone that's being saved, use the [◀] [▶] buttons to move the cursor and use the [- VALUE +] knob to specify characters.
  - 4-4. Press the [ENTER] (INIT) button.
  - 4-5. To execute, press the [ENTER] (INIT) button.



## Specifying the Key Range (KEY RANGE SETTINGS)

You can specify the key range to restrict a sound that you play or an arpeggio performance to a specific region on the keyboard.

→ “Specifying the Key Range” (p. 16)

## Playing Only the MODEL BANK Tones (SINGLE SETUP)

When SINGLE SETUP is executed, only part 1 is enabled, and you can perform with the tones of only one model.

1. Press the [MENU] (WRITE) button.
2. Use the [▲SELECT▼] knob to select “SINGLE SETUP,” and then press the [ENTER] (INIT) button.

A confirmation message for executing SINGLE SETUP is shown.

### MEMO

You can jump to the confirmation message for executing SINGLE SETUP by holding down the [SHIFT] button and pressing the [MODEL BANK] button.

3. Press the [ENTER] (INIT) button to execute SINGLE SETUP.

\* When SINGLE SETUP is executed, the scene data you were editing is lost. If you want to keep the data, save the scene before switching to SINGLE mode.

→ “Saving the Scene Settings (SCENE WRITE)” (p. 24)

\* The SINGLE SETUP state is canceled when you switch scenes.

\* The parameters that work with the controllers on this instrument such as the buttons and knobs differ with each model. See “Correspondence Between Controllers and Parameters” (p. 27) for more information.

## Editing the System Settings (System)

1. Press the [MENU] (WRITE) button.
2. Use the [▲SELECT▼] knob to select “SYSTEM,” and then press the [ENTER] (INIT) button.
3. Use the [◀] [▶] buttons to select the page that you want to edit.

### SYSTEM

Make basic device settings for the JUNO-X.

→ “Parameter Guide” (PDF)

### SYSTEM EFFECT: Dly

Choose whether the delay effect settings are fixed at the system settings, or are specified by each scene.

If “Source” is set to “SCENE,” use the scene effect parameters to edit the effect.

→ “Editing a Scene (SCENE EDIT)” (p. 22)

### SYSTEM EFFECT: Rev

Choose whether the reverb effect settings are fixed at the system settings, or are specified by each scene.

If “Source” is set to “SCENE,” use the scene effect parameters to edit the effect.

→ “Editing a Scene (SCENE EDIT)” (p. 22)

### SYSTEM EFFECT: Cho

Choose whether the chorus effect settings are fixed at the system settings, or are specified by each scene.

If “Source” is set to “SCENE,” use the scene effect parameters to edit the effect.

→ “Editing a Scene (SCENE EDIT)” (p. 22)

### SYSTEM EQ / COMP

Edit the equalizer and compressor settings.

### SYSTEM COLOR SET

Specify the color that is assigned to the buttons.

→ “Parameter Guide” (PDF)

4. Use the [▲SELECT▼] knob to select the parameter, and use the [- VALUE +] knob to change the value.

For details, refer to “Parameter Guide” (PDF).

5. To save the settings, hold down the [SHIFT] button and press the [MENU] (WRITE) button.

A confirmation message appears.

If you decide to cancel, press the [EXIT] button.

6. To execute, press the [ENTER] (INIT) button.

## Convenient Functions (UTILITY)

Execute convenient functions.

→ “Convenient Functions (UTILITY Screen)” (p. 45)

## Viewing the Software Version (INFORMATION)

View the software version.



# Saving the Settings (WRITE MENU)

## Accessing the WRITE MENU Screen

1. Hold down the [SHIFT] button and press the [MENU] (WRITE) button.
2. Use the [▲SELECT▼] knob to select the function you want to execute, and then press the [ENTER] (INIT) button.

### Saving Scenes and Tones at the Same Time

(SCENE & TONE)

You can save the scene settings and tone settings at the same time. If saving is needed, the screen indicates "EDITED."

This operation saves the tone settings for parts 1–4 in which the tones show "EDITED."

1. Hold down the [SHIFT] button and press the [MENU] (WRITE) button.
2. Use the [▲SELECT▼] knob to select "SCENE&TONE," and then press the [ENTER] (INIT) button.

\* If the tones in parts 1–4 do not show "EDITED," go to step 4.

3. Use the [▲SELECT▼] knob and the [- VALUE +] knob to select where to save the tones whose parts are shown as "EDITED," and press the [ENTER] (INIT) button.

To rename the tone, use the [▲SELECT▼] knob and buttons to move the cursor and use the [- VALUE +] knob to select the characters.

\* This is saved for each part that is shown as "EDITED."

4. Use the [▲SELECT▼] knob and the [- VALUE +] knob to select the save destination for the scene, and then press the [ENTER] (INIT) button.

If you want to rename the scene that's being saved, use the [▲SELECT▼] knob to move the cursor and use the [- VALUE +] knob to select the characters.

5. Press the [ENTER] (INIT) button.

A confirmation message appears.

If you decide to cancel, press the [EXIT] button.

6. To execute, press the [ENTER] (INIT) button.

### Saving a Scene (SCENE)

Here's how to save the scene settings. If saving is needed, the screen indicates "EDITED."

If the PART 1–4 tones are indicated as "EDITED," and you want to save the complete sound, save the tones first.

1. Hold down the [SHIFT] button and press the [MENU] (WRITE) button.
2. Use the [▲SELECT▼] knob to select "SCENE," and then press the [ENTER] (INIT) button.

3. Use the [▲SELECT▼] knob and the [- VALUE +] knob to select the save-destination, and then press the [ENTER] (INIT) button.

If you want to rename the scene that's being saved, use the [▲SELECT▼] knob to move the cursor and use the [- VALUE +] knob to select the characters.

4. Press the [ENTER] (INIT) button.

A confirmation message appears.

If you decide to cancel, press the [EXIT] button.

5. To execute, press the [ENTER] (INIT) button.

### Saving the Tone Settings of Each Part

(PART1–4 TONE)

Here's how to save the tone settings of each part.

1. Hold down the [SHIFT] button and press the [MENU] (WRITE) button.
2. Use the [▲SELECT▼] knob to select the part where the tone you want to save is assigned, and then press the [ENTER] (INIT) button.

3. Use the [▲SELECT▼] knob and the [- VALUE +] knob to select the save-destination, and then press the [ENTER] (INIT) button.

If you want to rename the tone that's being saved, use the [▲SELECT▼] knob to move the cursor and use the [- VALUE +] knob to select the characters.

4. Press the [ENTER] (INIT) button.

A confirmation message appears.

If you decide to cancel, press the [EXIT] button.

5. To execute, press the [ENTER] (INIT) button.

### Editing the System Settings (System)

Here's how to save the system settings.

1. On the SYSTEM screen, hold down the [SHIFT] button and press the [MENU] (WRITE) button.

The SYSTEM WRITE screen appears.

If you decide to cancel, press the [EXIT] button.

#### MEMO

If the WRITE MENU screen appears, use the [▲SELECT▼] knob to select "SYSTEM," and then press the [ENTER] (INIT) button.

2. To execute, press the [ENTER] (INIT) button.

# Convenient Functions (UTILITY Screen)

## Backing-Up Data to a USB Flash Drive

Connect a USB flash drive.

\* Use a commercially available USB flash drive. Note that we cannot guarantee that all commercially available USB flash drives will work.



## Formatting a USB Flash Drive

(FORMAT USB MEMORY)

Be sure to format your USB flash drive on this instrument, if you are using it for the first time.

### NOTE

If the USB flash drive contains important data, be aware that this operation erases all data from the drive.

1. Press the [MENU] (WRITE) button.
2. Use the [▲SELECT▼] knob to select "UTILITY," and then press the [ENTER] (INIT) button.
3. Use the [▲SELECT▼] knob to select "FORMAT USB MEMORY," and then press the [ENTER] (INIT) button.

A confirmation message appears.

If you decide to cancel, press the [EXIT] button.

4. To execute, use the [- VALUE +] knob or the [◀] [▶] buttons to select "OK," and then press the [ENTER] (INIT) button.

When formatting is complete, the screen indicates "Completed!"

\* Never turn off the power or disconnect the USB flash drive during a process, such as while the "Executing..." display is shown.

## Backing-Up Data to USB Flash Drive (BACKUP)

Here's how to back up user data to a USB flash drive.

### Data that is backed up

- All scene data (including vocoder and arpeggio settings)
- User tone data
- System settings (including system effects)

1. Press the [MENU] (WRITE) button.
2. Use the [▲SELECT▼] knob to select "UTILITY," and then press the [ENTER] (INIT) button.
3. Use the [▲SELECT▼] knob to select "BACKUP," and then press the [ENTER] (INIT) button.  
The BACKUP screen appears.
4. Use the [▲SELECT▼] knob to move the cursor, and use the [- VALUE +] knob to edit the characters.
5. Once you've entered the filename, press the [ENTER] (INIT) button.

A confirmation message appears.

If you decide to cancel, press the [EXIT] button.

6. To execute, use the [- VALUE +] knob or the [◀] [▶] buttons to select "OK," and then press the [ENTER] (INIT) button.

When the backup is finished, the screen indicates "Completed!"  
If a file of the same name exists, a confirmation screen (Overwrite?) asks whether you want to overwrite the existing file.

\* Never turn off the power or disconnect the USB flash drive during a process, such as while the "Executing..." display is shown.

## Restoring Backup Data (RESTORE)

Here's how user data that you backed up on a USB flash drive can be returned to the JUNO-X. This operation is called "restore."

### NOTE

All user data are rewritten when you execute the restore operation. If your JUNO-X contains important data, assign it a different name and back it up to a USB flash drive before you restore.

1. Press the [MENU] (WRITE) button.
2. Use the [▲SELECT▼] knob to select "UTILITY," and then press the [ENTER] (INIT) button.
3. Use the [▲SELECT▼] knob to select "RESTORE," and then press the [ENTER] (INIT) button.
4. Use the [▲SELECT▼] knob to select the file to restore, and then press the [ENTER] (INIT) button.

A confirmation message appears.

If you decide to cancel, press the [EXIT] button.

5. To execute, use the [- VALUE +] knob or the [◀] [▶] buttons to select "OK," and then press the [ENTER] (INIT) button.

When the restore operation is finished, the screen indicates "Completed. Turn off power."

6. Turn the power of the JUNO-X off and then on again.

\* Never turn off the power or disconnect the USB flash drive during a process, such as while the "Executing..." display is shown.

## Using the IMPORT/EXPORT Function

### Importing Tones

You can import tones that you've downloaded from Roland Cloud (\*) or exported from other instruments into the JUNO-X as additional tones.

\* You can also import tones from models.

When you import a tone that does not belong to a model, the model name is saved as "Z-Core."

#### (\*) What is Roland Cloud?

Roland Cloud is a cloud-based subscription service that offers high-quality plug-in sound engines and software for music production.

[https://www.roland.com/global/categories/roland\\_cloud/](https://www.roland.com/global/categories/roland_cloud/)

### Saving tones to USB flash drive

1. Prepare a SVZ file with the tones you've downloaded or exported from other models by using their export function, which you'll import into the JUNO-X.
2. Connect a USB flash drive to your computer.
  - \* If this is the first time you're using the USB flash drive, format it on the JUNO-X.
    - "Formatting a USB Flash Drive (FORMAT USB MEMORY)" (p. 45)
3. Save the SVZ file to the "ROLAND/SOUND" folder on your USB flash drive.
4. Remove the USB flash drive from your computer and connect it to the JUNO-X.

### Importing tones into the JUNO-X

1. Press the [MENU] (WRITE) button.
2. Use the [▲SELECT▼] knob to select "UTILITY," and then press the [ENTER] (INIT) button.
3. Use the [▲SELECT▼] knob to select "IMPORT/EXPORT," and then press the [ENTER] (INIT) button.
4. Use the [▲SELECT▼] knob to select "IMPORT TONE," and then press the [ENTER] (INIT) button.
5. Use the [▲SELECT▼] knob to select the file containing the tone you wish to import, and press the [▶] button.
 

The number of tones that are saved in that file are shown in parentheses.
6. Use the [▲SELECT▼] knob to select the tone you wish to import, and use the [- VALUE +] knob to select it with a check mark.
 

To select/deselect all tones  
Hold down the [SHIFT] button and turn the [- VALUE +] knob.

To specify a range of tones to select/deselect  
Press the [ENTER] (INIT) button at the beginning of the range, and then press [ENTER] (INIT) while holding the [SHIFT] button at the end of the range.
7. Press the [▶] button.
8. Use the [▲SELECT▼] knob to select where to import the tone, and press the [ENTER] (INIT) button to select it with a check mark.

#### NOTE

- Tones that are being used in a scene are marked with an asterisk (\*).
- Use caution, as this overwrites the tone you select that's already in the import destination.
- If there are not enough locations in the import destination to save the data to be imported, not all of the tones selected are imported.
- You can check the number of tones at the top right-hand part of the screen.

#### Number of tones in import destination and source

- If a tone named "INIT TONE" already exists, this is automatically selected with a check mark as the import destination tone.
- \* If a tone named "INIT TONE" already exists, it is automatically selected as the import destination tone, even it was previously edited.
- To leave the tone as-is, clear the check mark.

#### 9. Press the [▶] button.

#### 10. To execute, use the [- VALUE +] knob to select "OK," and then press the [ENTER] (INIT) button.

The display shows "Import Tone Completed!" when importing is done.

\* Never turn off the power or disconnect the USB flash drive when "Executing..." or a similar message is shown on the screen, as the unit is processing data.

### Importing Scenes

You can import scenes into the JUNO-X as additional scenes that were exported from the JUNO-X.

\* You can also import scenes from a backup file.

### Saving scenes to USB flash drive

1. Prepare a SVD file with the scenes you've exported from the JUNO-X by using its export function, which you'll import into the JUNO-X.
2. Connect a USB flash drive to your computer.
  - \* If this is the first time you're using the USB flash drive, format it on the JUNO-X.
    - "Formatting a USB Flash Drive (FORMAT USB MEMORY)" (p. 45)
3. Save the SVD file to the "ROLAND/SOUND" folder on your USB flash drive.
4. Remove the USB flash drive from your computer and connect it to the JUNO-X.

### Importing scenes into the JUNO-X

1. Press the [MENU] (WRITE) button.
2. Use the [▲SELECT▼] knob to select "UTILITY," and then press the [ENTER] (INIT) button.
3. Use the [▲SELECT▼] knob to select "IMPORT/EXPORT," and then press the [ENTER] (INIT) button.
4. Use the [▲SELECT▼] knob to select "IMPORT SCENE," and then press the [ENTER] (INIT) button.
5. Use the [▲SELECT▼] knob to select the file containing the scene you wish to import, and press the [▶] button.

- Use the [▲SELECT▼] knob to select the scene you wish to import, and use the [- VALUE +] knob to select it with a check mark.

To select/deselect all scenes

Hold down the [SHIFT] button and turn the [- VALUE +] knob.

To specify a range of scenes to select/deselect

Press the [ENTER] button at the beginning of the range, and then press [ENTER] while holding the [SHIFT] button at the end of the range.

- Press the [▶] button.
- Use the [▲SELECT▼] knob to select where to import the scene, and press the [ENTER] (INIT) button to select it with a check mark.

#### NOTE

- Use caution, as this overwrites the scene that's already in the import destination.
- If there are not enough scenes in the import destination to save the data to be imported, not all of the scenes selected are imported.
- You can check the number of scenes at the top right-hand part of the screen.

#### Number of scenes in import destination and source

- If a scene named "INIT SCENE" already exists, this is automatically selected as the import destination scene with a check mark.
- \* If a scene named "INIT SCENE" already exists, it is automatically selected as the import destination scene, even if it was previously edited.
- To leave the scene as-is, clear the check mark.

- Press the [▶] button.
- To execute, use the [- VALUE +] knob to select "OK," and then press the [ENTER] (INIT) button.

When importing, the tone is saved with the name "INIT TONE." The display shows "Import Scene Completed!" when importing is done.

- \* If a user tone is being used by the scene of the import destination, you can select whether to import that user tone as well.
- \* Never turn off the power or disconnect the USB flash drive when "Executing..." or a similar message is shown on the screen, as the unit is processing data.

## Exporting Tones

You can export the user tone data to an SVZ file.

- \* You can also export tones from models.

- Connect a USB flash drive.
- Press the [MENU] (WRITE) button.
- Use the [▲SELECT▼] knob to select "UTILITY," and then press the [ENTER] (INIT) button.
- Use the [▲SELECT▼] knob to select "IMPORT/EXPORT," and then press the [ENTER] (INIT) button.
- Use the [▲SELECT▼] knob to select "EXPORT TONE," and then press the [ENTER] (INIT) button.
- Use the [▲SELECT▼] knob to select where to export the tone from, and press the [ENTER] (INIT) button to select it with a check mark.

To select/deselect all tones

Hold down the [SHIFT] button and turn the [- VALUE +] knob.

To specify a range of tones to select/deselect

Press the [ENTER] (INIT) button at the beginning of the range, and then press [ENTER] (INIT) button while holding the [SHIFT] button at the end of the range.

- Press the [▶] button.
- Move the cursor using the [◀] [▶] buttons, and use the [- VALUE +] knob to edit the characters.
- Once you've entered the filename, press the [ENTER] (INIT) button.

A confirmation message appears.

If you decide to cancel, press the [EXIT] button.

- To execute, use the [- VALUE +] knob to select "OK," and then press the [ENTER] (INIT) button.
- The scenes are exported to the "ROLAND/SOUND" folder on your USB flash drive. The display shows "Export Tone Completed!" when exporting is done.

- \* Never turn off the power or disconnect the USB flash drive during a process, such as while the "Executing..." display is shown.

## Exporting Scenes

You can export the scene data to an SVD file.

- Connect a USB flash drive.
- Press the [MENU] (WRITE) button.
- Use the [▲SELECT▼] knob to select "UTILITY," and then press the [ENTER] (INIT) button.
- Use the [▲SELECT▼] knob to select "IMPORT/EXPORT," and then press the [ENTER] (INIT) button.
- Use the [▲SELECT▼] knob to select "EXPORT SCENE," and then press the [ENTER] (INIT) button.
- Use the [▲SELECT▼] knob to select where to export the scene from, and press the [ENTER] (INIT) button to select it with a check mark.

To select/deselect all scenes

Hold down the [SHIFT] button and turn the [- VALUE +] knob.

To specify a range of scenes to select/deselect

Press the [ENTER] (INIT) button at the beginning of the range, and then press [ENTER] (INIT) while holding the [SHIFT] button at the end of the range.

- Press the [▶] button.
- Move the cursor using the [◀] [▶] buttons, and use the [- VALUE +] knob to edit the characters.
- Once you've entered the filename, press the [ENTER] (INIT) button.

A confirmation message appears.

If you decide to cancel, press the [EXIT] button.

- To execute, use the [- VALUE +] knob to select "OK," and then press the [ENTER] (INIT) button.
- The scenes are exported to the "ROLAND/SOUND" folder on your USB flash drive. The display shows "Export Scene Completed!" when exporting is done.
- \* Never turn off the power or disconnect the USB flash drive during a process, such as while the "Executing..." display is shown.

## Exporting Step Edit Patterns

Use these steps to export the step edit pattern data in a scene to your USB flash drive as MIDI data (SMF).

1. Connect a USB flash drive.
2. Press the [MENU] (WRITE) button.
3. Use the [▲SELECT▼] knob to select “UTILITY,” and then press the [ENTER] (INIT) button.
4. Use the [▲SELECT▼] knob to select “IMPORT/EXPORT,” and then press the [ENTER] (INIT) button.
5. Use the [▲SELECT▼] knob to select “EXPORT USER PATTERN,” and then press the [ENTER] (INIT) button.
6. Use the [◀] [▶] buttons to move the cursor, and use the [- VALUE +] knob to edit the characters.
7. Once you’ve entered the filename, press the [ENTER] (INIT) button.

A confirmation message appears.

If you decide to cancel, press the [EXIT] button.

8. To execute, use the [- VALUE +] knob to select “OK,” and then press the [ENTER] (INIT) button.

The data is exported to the “EXPORT” folder on your USB flash drive.

\* Never turn off the power or disconnect the USB flash drive during a process, such as while the “Executing...” display is shown.

## About exported MIDI files

- The SMF format used is Format0.
- Files are output by part, and the “\_\*” (with the asterisk representing the part number) is appended to the filenames. The MIDI channel follows the settings on this unit (SCENE PART EDIT > Rx Ch).
- Only parts that contain user pattern data are exported.
- Tone-related data is not included.

## Returning to the Factory Settings

### (FACTORY RESET)

Here’s how the settings that you edited and saved on the JUNO-X can be returned to their factory settings.

\* When you execute this operation, all saved settings including the sound parameters will be lost.

\* If you will later need the current settings, be sure to use the backup function (p. 45) to save the current settings before you restore the factory settings.

1. Press the [MENU] (WRITE) button.
2. Use the [▲SELECT▼] knob to select “UTILITY,” and then press the [ENTER] (INIT) button.
3. Use the [▲SELECT▼] knob to select “FACTORY RESET,” and then press the [ENTER] (INIT) button.

The FACTORY RESET screen appears.

If a sound pack or wave expansion is imported/installed

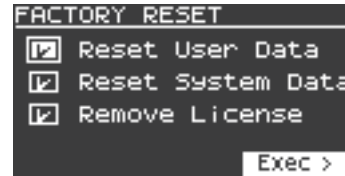

If a sound pack or wave expansion is not imported/installed



4. Use the [▲SELECT▼] knob to select the item to execute, and press the [ENTER] (INIT) button to select its check box.

Press the [ENTER] (INIT) button again to clear the check box.

Item	Explanation
Reset User Data	Initializes the scenes and user tones (*1).
Reset System Data	Initializes the system settings (*1).
Remove License (*2)	Initializes the user license and wave expansion. Initializing the user license lets you import/install a sound pack or wave expansion that was downloaded with a different user license. This deletes the currently installed wave expansion.

\* 1 Performing these operations erases any of the relevant data you have edited after purchase.

To save the current settings, be sure to use the backup function (p. 45) before you restore the unit to its factory default state.

\* 2 This is displayed if a sound pack or wave expansion is imported/installed.

For more details on user licenses, see the “Roland Cloud Sound Pack/ Wave Expansion User’s Guide” (PDF).

5. Press the [▶] button.

A confirmation message appears.

If you decide to cancel, press the [EXIT] button.

6. To execute, use the [- VALUE +] knob to select “OK,” and then press the [ENTER] (INIT) button.

The display indicates “Completed. Turn off power.”

7. Turn the power of the JUNO-X off and then on again.

\* Never turn off the power or disconnect the USB flash drive during a process, such as while the “Executing...” display is shown.

# Sound Engine Routing Details

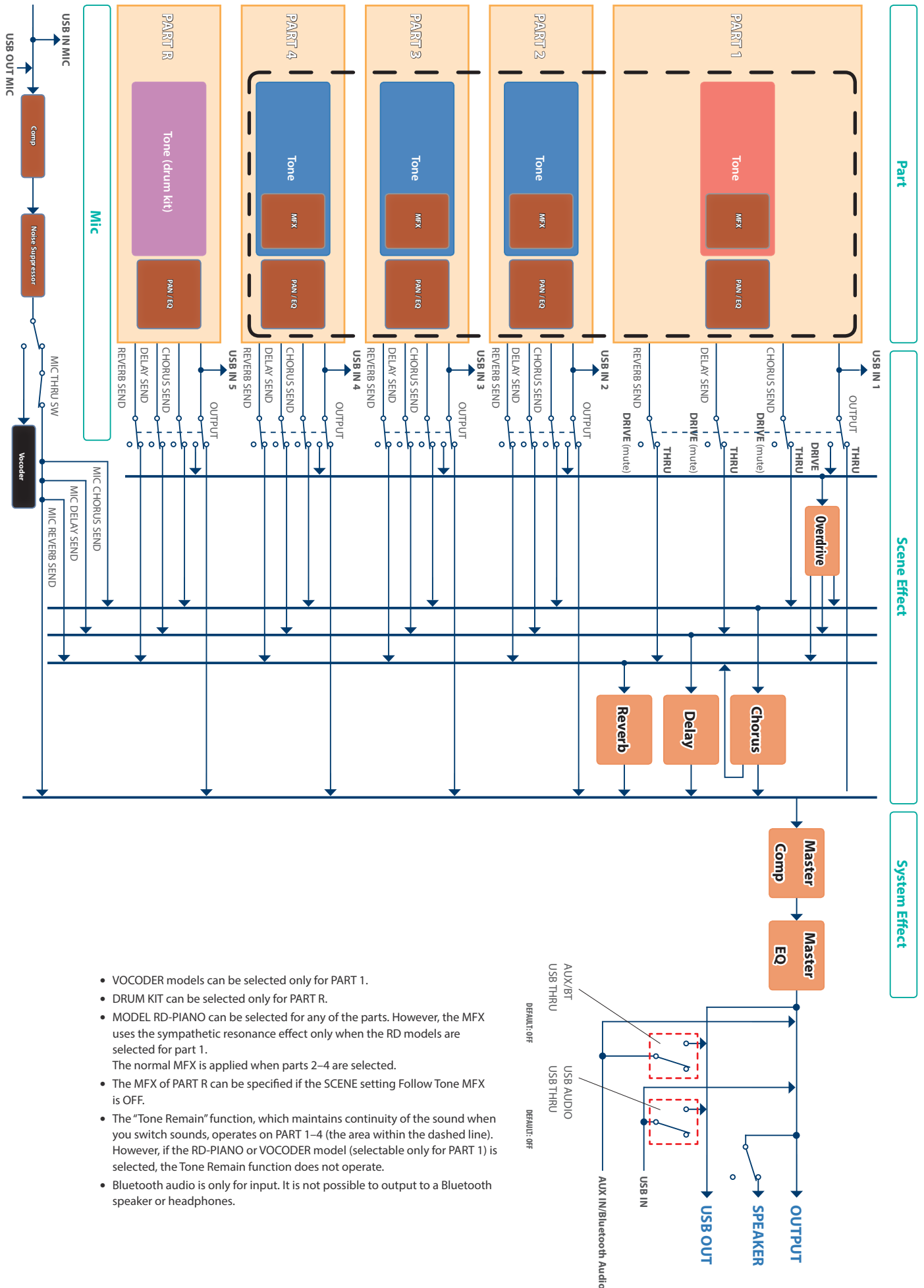

- VOCODER models can be selected only for PART 1.
- DRUM KIT can be selected only for PART R.
- MODEL RD-PIANO can be selected for any of the parts. However, the MFX uses the sympathetic resonance effect only when the RD models are selected for part 1. The normal MFX is applied when parts 2–4 are selected.
- The MFX of PART R can be specified if the SCENE setting Follow Tone MFX is OFF.
- The “Tone Remain” function, which maintains continuity of the sound when you switch sounds, operates on PART 1–4 (the area within the dashed line). However, if the RD-PIANO or VOCODER model (selectable only for PART 1) is selected, the Tone Remain function does not operate.
- Bluetooth audio is only for input. It is not possible to output to a Bluetooth speaker or headphones.



# Error Messages

Message	Explanation
Messages that disappear after a timeout	
No TONes.	When you press a model bank button, there is no tone to recall.
MIDI Offline!	The MIDI connection is broken.
MIDI Buffer Full!	The MIDI IN connector's input buffer has overflowed.
MIDI CommunicationError!	A hardware error occurred at the MIDI IN/OUT connector.
Messages that disappear when you press the [EXIT] button	
Read Error!	An error occurred when reading from a USB flash drive.
Write Error!	An error occurred when writing to a USB flash drive.
USB Memory Not Ready!	The USB flash drive is not ready.
USB Memory Full!	The USB flash drive has no free capacity.
Can't Reset.	An error occurred during factory reset.
FORMAT USB Mem Error!	An error occurred when formatting the USB flash drive.
No Data.	<b>USER PATTERN EXPORT:</b> There is no data to export.
SMF Make Error.	<b>USER PATTERN EXPORT:</b> An error occurred during SMF conversion.
Buffer Full nnn	A control buffer overflowed. <b>nnn = 000:</b> Controller control buffer <b>nnn = 001:</b> Parameter control buffer <b>nnn = 002:</b> Panel CPU message reception buffer <b>nnn = 003:</b> User interface control buffer <b>nnn = 004:</b> MIDI System Exclusive transmission control buffer



## Overall / System

### 01 Does the sound change as on an analog synthesizer according to temperature and the passage of time?

Yes.

If the Aging function is "ON," an internal temperature sensor is used to apply change to some synthesizer sounds (sounds for which the TONE parameter Pitch Drift is specified), simulating the way in which temperature variation and the passage of time after startup can affect the sound of an analog synthesizer.

Turn the Aging function "ON" as described below, and notice how the sound changes.

1. Press the [MENU] (WRITE) button.
2. Use the [▲SELECT▼] knob to select "SYSTEM," and then press the [ENTER] (INIT) button.
3. Use the [▲SELECT▼] knob to select "Warm-up," and use the [- VALUE +] knob to select either "ON" or "FAST."

ON	Simulation is on. The status of Pitch Drift will change in approximately ten minutes, and will subsequently stabilize at the value of the TONE setting Pitch Drift.
FAST	This mode shortens the change of the ON setting to approximately ten seconds, allowing you to hear the effect of Pitch Drift.
FIXED	The internal temperature is fixed at the value specified by Init Temp, and the character of the sound at that point is maintained.

4. Hold down the [SHIFT] button and press the [MENU] (WRITE) button to save the edited settings.

### 02 Can the internal speaker be turned off at all times?

Yes.

Use the following procedure to turn the internal speaker "OFF."

1. Press the [MENU] (WRITE) button.
2. Use the [▲SELECT▼] knob to select "SYSTEM," and then press the [ENTER] (INIT) button.
3. Use the [▲SELECT▼] knob to select "Speaker Sw," and use the [- VALUE +] knob to specify "OFF."
4. Hold down the [SHIFT] button and press the [MENU] (WRITE) button to save the edited settings.

### 03 Do the internal speakers produce enough volume for a live performance?

They are not suitable for this purpose.

The internal speakers are intended for personal enjoyment by the individual who is playing the instrument. For use in a live performance, we recommend that you connect an external amp or speaker.

### 04 How do I save a sound that I created?

To completely save and reproduce the sound that you're currently hearing, you must save both the tones and the scene.

Save this data as follows.

#### Saving the tone

1. Select the edited tone, and press the [MENU] (WRITE) button while holding down the [SHIFT] button.
2. Use the [▲SELECT▼] knob to select the part where the tone you want to save is assigned, and then press the [ENTER] (INIT) button.
3. Select the save-destination, and then press the [ENTER] (INIT) button.
4. If you want to rename the tone that's being saved, use the [◀] [▶] buttons to move the cursor and use the [- VALUE +] knob to specify characters.
5. Press the [ENTER] (INIT) button.  
A confirmation message appears.  
If you decide to cancel, press the [EXIT] button.
6. To execute, press the [ENTER] (INIT) button.

#### Saving the scene

1. Select the edited scene, hold down the [SHIFT] button and press the [MENU] (WRITE) button.
2. Use the [▲SELECT▼] knob to select "SCENE," and then press the [ENTER] (INIT) button.
3. Select the save-destination, and then press the [ENTER] (INIT) button.  
If you want to rename the scene that's being saved, use the [◀] [▶] buttons to move the cursor and use the [- VALUE +] knob to specify characters.
4. Press the [ENTER] (INIT) button.  
A confirmation message appears.  
If you decide to cancel, press the [EXIT] button.
5. To execute, press the [ENTER] (INIT) button.

### 05 Is this unit equipped with Bluetooth functionality?

Yes, it is.

You can use its Bluetooth functionality in the following ways.

#### Bluetooth audio

Music played back from your mobile device can be mixed with the sound of the internal sound engine, and output from this unit.

\* To adjust the playback volume, adjust the volume on your mobile device or adjust the System setting "AuxIn/BT InLev."

#### Bluetooth MIDI

You can also use apps with this instrument that are compatible with Bluetooth MIDI (such as GarageBand).

## 06 Are Bluetooth earphones or headphones supported?

No, they are not supported.

## 07 Can I specify a MIDI channel for each part?

Yes.

The MIDI channel is specified by the “Rx Ch” parameter in the SCENE PART EDIT screen for each part.

## Operation

### 08 Why do the panel knobs and buttons work sometimes and not at other times?

The parameters are different for each model, so there are cases in which a controller has no parameter. Since the controllers without a parameter differ between models, a controller might or might not have an effect.

The parameter that is controlled by each knob or button will differ depending on the model used by the tone that’s assigned to the current part (the currently selected part).

→ “Correspondence Between Controllers and Parameters” (p. 27)

### 09 Is there a way to move quickly to the edit screen for the parameter controlled by each knob?

Yes.

#### 1. Hold down the [SHIFT] button and turn the knob of the parameter that you want to edit.

The settings screen for each knob appears.

→ “Correspondence Between Controllers and Parameters” (p. 27)

### 10 Is there a way to move quickly to the settings screen for the [SL1] and [SL2] sliders or the [S1], [S2] and [S3] buttons?

Yes.

#### 1. Hold down the [SHIFT] button and operate the slider or button that you want to assign.

The assignment screen for the corresponding controller appears.

### 11 Is there a way to check the current value of a setting without affecting the state of the sound?

Yes.

#### 1. Hold down the [EXIT] button and operate the knob that you want to check.

The current value of the setting is shown.

### 12 The part on/off button is lit, but I can’t play the sound of that part from the keyboard.

(PART/OSC ON [1]–[R] buttons, when the [PART/FUNC] button is lit up yellow—at factory default)

This might be due the following reasons.

- The part might be assigned for arpeggio performance
- The I-ARPEGGIO ON/OFF button is ON, and the ARPEGGIO PART EDIT parameter Switch is “ON.”

→ “If the Keyboard Does Not Play Sound” (p. 21)

### 13 Is there a way to move quickly to the TONE (PARTIAL) edit screen?

Yes.

#### 1. While holding down the [SHIFT] button, operate the sliders for each waveform in the OSC section (square wave, sawtooth wave, SUB and NOISE).

The edit screen for the corresponding tone or partial appears.

\* The screen contents may vary, depending on the model.

### 14 Can I change the models or categories that are recalled by the [MODEL BANK] buttons [1]–[16]?

Yes.

#### 1. Hold down the [MODEL BANK] button and then press the [1]–[16] buttons.

The model or category recalled by the [MODEL BANK] button can be set for each bank.

\* Up to eight can be set for each button (BANK).

#### 2. Use the [▲SELECT▼] knob to move the cursor to “Attr:”

#### 3. Use the [- VALUE +] knob to select the model/category/user.

#### 4. Use the [▲SELECT▼] knob to select the model number you want to change.

#### 5. Use the [- VALUE +] knob to select a model name (device name) or category name.

\* You can register up to eight models or categories in one model bank.

\* You can’t mix and assign both a model and a category in a single model bank.

#### 6. If you want to save the setting, execute the System Write operation.

##### 6-1. Hold down the [SHIFT] button and press the [MENU] (WRITE) button.

The WRITE MENU screen appears.

##### 6-2. Use the [▲SELECT▼] knob to select “SYSTEM,” and then press the [ENTER] (INIT) button.

##### 6-3. To execute, press the [ENTER] (INIT) button.

## Sound Module

### 15 What is the meaning of "MODEL" in a model bank?

A model is a sound engine that reproduces the sounds and parameter changes of famous vintage analog synthesizers and other historical instruments. Some models provide not only the sounds that were found on the original, but also newly re-created sounds.

### 16 What varieties of "MODEL" are provided?

Six types are provided: JUNO-X, JUNO-106, JUNO-60, XV-5080, RD-PIANO, and VOCODER.

### 17 Can a model be used with more than one part?

This depends on the model.

"VOCODER" can be used only with part 1.

Other models can be used with parts 1–4.

### 18 Can a drum kit be used with any part?

No, a drum kit can be used only with part R.

It cannot be used with parts 1–4.

### 19 Is the unit equipped with a vocoder?

Yes, it is.

To use the vocoder, proceed as follows (with the factory settings).

1. **Connect a dynamic microphone or an electret condenser microphone to the rear panel MIC IN jack.**
2. **Use the rear panel MIC IN [GAIN] knob to adjust the volume.**
3. **Select part 1, and then press the [MODEL BANK] button to make it light.**
4. **Press the [MODEL BANK] button and then press button [6].**
  - \* With the factory settings, "VOCODER" is assigned to the model bank of the [6] button.
  - You can change the model bank that is assigned.
  - "Registering to a model bank" (p. 14)
5. **Use the [- VALUE +] knob to select a vocoder sound (two types).**
6. **While playing the keyboard, vocalize into the microphone.**

The vocoder effect is applied.

\* Phantom-powered condenser microphones are not supported.

### 20 Can I input audio playback from my computer instead of audio from the mic input, and apply the vocoder?

Yes, you can.

1. **Connect the JUNO-X with your computer via USB.**
2. **Choose "OUT MIC" as the audio output device of your computer.**

Now the audio playback of your computer can be used for vocoder performance.

### 21 What is the maximum simultaneous polyphony?

It differs depending on the type and combination of models.

The JUNO-X model has a maximum polyphony of 16 notes. Note that the polyphony is reduced if you are using multiple parts at the same time.

In the case of PCM sounds, up to 256 notes (for MONO) can be produced.

### 22 Can I edit from the initialized sound of a model?

Yes.

Initialize the tone as follows.

1. **Select the tone to initialize, hold down the [SHIFT] button and press the [ENTER] (INIT) button.**
2. **Use the [▲SELECT▼] knob to select "TONE."**
3. **Press the [ENTER] (INIT) button.**
4. **Press the [ENTER] (INIT) button to initialize the tone.**

\* The initialized sound and settings differ depending on the model.

\* Depending on the scene settings, the sound of multiple parts might be layered, or the part parameter settings might not produce the sound that you expect. In this case, you should first initialize the scene before initializing the tone.

### 23 What is the difference between the VINTAGE FILTER [R] [M] [S] buttons?

**[R]** This is the filter of the original Roland model, and is selected by default.

**[M] [S]** These model the filters of vintage synthesizers made by other companies.

When a vintage type model is selected, you can use the VINTAGE FILTER [R] [M] [S] buttons to change the filter type.

## Effects

### 24 Which parameters are associated with the knobs of the effect section?

This varies depending on settings such as SCENE PART EDIT: Output and SCENE PART MFX: FilwToneMFX.

The easiest way to find the associated parameter is to hold down the [SHIFT] button and operate the corresponding button, so that the associated parameter screen appears.

## Arpeggio

### 25 What is the I-Arpeggio function?

I-Arpeggio is a new type of arpeggiator in which built-in AI analyzes your keyboard performance and switches to the optimal arpeggio pattern in real time.

It differs from conventional arpeggiators in the following ways.

- It allows multi-part performance, and lets you freely specify the parts to play manually and the parts played by the arpeggiator.
- You can enable or disable change by turning the PLAY DETECTOR [KEYS] and [BEAT] buttons on/off.

### 26 How do I use the PLAY DETECTOR [KEYS] button and [BEAT] button?

#### [KEYS] button

This specifies whether the constituent notes of the arpeggio performance will change according to your keyboard playing. For example, if you want the constituent notes that you've once specified from the keyboard to remain the same while you add additional notes from your keyboard performance, turn the [KEYS] button off.

#### [BEAT] button

This specifies whether your performance will affect the arpeggio pattern.

For example, if you want to change the chord without changing the performance pattern, turn the [BEAT] button off and the [KEYS] button on.

If KEYS and BEAT are both off, the current arpeggio performance is kept. You can freely solo on the keyboard while that accompaniment remains fixed.

### 27 Can I mute a part while the arpeggio is playing?

Yes.

#### 1. With the [PART/FUNC] button lit, hold down the [SHIFT] button and press the PART/OSC ON [1]–[R] buttons for the part(s) that you want to mute.

The switches of each part can be turned on/off.

For example, you can temporarily mute just the drum sound while you're playing (hold down the [SHIFT] button and press the PART/OSC ON [R] button).

By editing the SYSTEM parameter "PART Btn Asgn," you can customize the function of the buttons for part select mode.

→ "Assigning Functions to the [4]–[13] Buttons" (p. 15)

### 28 Can I edit the I-Arpeggio pattern data?

No, it is not possible to edit the I-Arpeggio pattern data itself.

A pattern that you entered using STEP EDIT can be used as part of an I-Arpeggio. In this case, however, it is used as fixed pattern data, and does not change according to the performance.

### 29 Can I record or edit the I-Arpeggio performance?

You can edit it.

Each cycle of the arpeggio performance is always recorded internally, and can be accessed and edited by the STEP EDIT function. The edited pattern can be used as an arpeggio user pattern, or used as MIDI data in your DAW software.

### 30 Can I use STEP EDIT to change the number of recorded steps for the arpeggio performance?

Yes.

Change the necessary parameter settings as follows.

1. Press the [STEP EDIT] button.
2. Turn the [▲SELECT▼] knob while holding down the [SHIFT] button to edit the Grid Length.

### 31 When I copy in the Copy I-Arp screen, parts that don't play are sometimes recorded.

If in SCENE EDIT COMMON, any one of the ASSIGN parameters SL1, SL2, or Ctrl are assigned to "PART FADE1" or "PART FADE2," a part whose volume was too small to hear might be played in STEP EDIT.

In this case, delete the STEP data of the unwanted part.

### 32 Can I prevent the I-Arpeggio TYPE and RHYTHM from changing the sound or tempo?

Yes.

Proceed as follows.

1. Press the [MENU] (WRITE) button.
2. Select "SYSTEM," and then press the [ENTER] (INIT) button.
3. Use the [▲SELECT▼] knob to select the following ARPEGGIO parameters, and use the [- VALUE +] knob to turn each "OFF:"

Set Tone

Set Drumkit

Set Tempo

4. To save the edited settings, hold down the [SHIFT] button and press the [MENU] (WRITE) button.
5. When the screen asks, "SYSTEM WRITE Are you sure?," press the [ENTER] (INIT) button.

The screen indicates "Now writing...," and you return to the SYSTEM setting screen.

### 33 Can the I-Arpeggio synchronize with the tempo of an external sequencer?

Yes.

In SYSTEM settings, set the TEMPO/SYNC parameters as appropriate for your situation.

→ "Parameter Guide" (PDF)

### 34 Can I connect an external MIDI keyboard and use it for keyboard performance with I-Arpeggio?

Yes.

Make remote keyboard settings as follows.

1. Press the [MENU] (WRITE) button.
2. Select "SYSTEM," and then press the [ENTER] (INIT) button.
3. Use the [▲SELECT▼] knob to select "MIDI: Remote Kbd."
4. Use the [- VALUE +] knob to select the connector/port to which you connect your external MIDI keyboard. You can select "MIDI IN," "USB COM" or "USB MEM."
5. To save the edited settings, hold down the [SHIFT] button and press the [MENU] (WRITE) button.
6. When the screen asks, "SYSTEM WRITE Are you sure?," press the [ENTER] (INIT) button.

The screen indicates "Now writing...," and you return to the SYSTEM setting screen.

# Main Specifications

Keyboard	61 Keys (channel aftertouch)
Sound Generator	ZEN-Core Various MODEL sound generators
Parts	5 parts (Play part: 4, Rhythm part: 1)
Tones	Preset tone: 4,000 or greater User tone: 256 Drum Kit: 90 or greater
Scene	256
Effects	Multi-Effects: 4 systems, 93 types
	Part EQ: 5 systems
	Overdrive
	Reverb: 8 types Chorus: 5 types Delay: 5 types
	Mic NS / Compressor Master EQ / Compressor
Arpeggiator	I-ARPEGGIO (Multi parts arpeggiator with playing detection)
Arpeggio Parts	5 parts
Controllers	Pitch Bend/Modulation Lever Assignable Slider x 2 Assignable Switch x 3
Bluetooth	Ver 4.2 Profile Support: A2DP (Audio), GATT (MIDI over Bluetooth Low Energy) Codec: SBC (Support to the content protection of the SCMS-T method)
Display	Graphic LCD 128 x 64 dots
Speaker Amplifier Power Output	4W x 2
Speakers	Full range (3.5 x 8 cm) x 2 Tweeter 2 cm x 2
Connectors	HEADPHONES jacks: Stereo miniature phone type (front), Stereo 1/4-inch phone type (rear) MAIN OUT jacks (L/MONO, R): 1/4-inch phone type MAIN OUT jacks (L, R): XLR type MIC INPUT jack: 1/4 inch phone type/XLR type AUX INPUT jack: Stereo miniature phone type HOLD PEDAL jack CONTROL PEDAL jack MIDI connectors (IN, OUT) USB COMPUTER port (AUDIO/MIDI) USB MEMORY port
External Memory	USB Flash drive (commercially available)
Power Consumption	20 W
Dimensions	1,072 (W) x 333 (D) x 118 (H) mm
Weight	11.6 kg
Accessories	Startup Guide Power cord
Options	Keyboard Stand: KS-10Z, KS-12 Pedal Switch: DP series Expression Pedal: EV-5

\* This document explains the specifications of the product at the time that the document was issued. For the latest information, refer to the Roland website.