



magnifi mini™

Home Theater Sound Bar System™

Quick Start Guide

Thank you for your Polk purchase. If you have a question or comment, please feel free to call or email us.

Technical Assistance

In North America, call Polk Customer Service at **800-377-POLK(7655)** (M-F, 9 a.m.–5:30 p.m. EST)

Outside the US, call **+1-410-358-3600**

email **polkcs@polkaudio.com**

Polk Audio
1 Viper Way, Vista, CA 92081

The complete owner's manual can be found online at **www.polkaudio.com**

What's in the Box

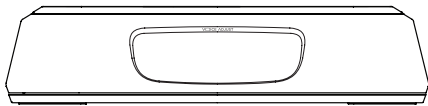

Sound bar



Remote control



Batteries



Literature



Sound bar power cord

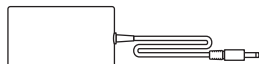

Sound bar power supply

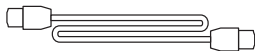

6.5' HDMI cable

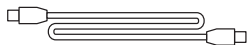

6' Optical cable

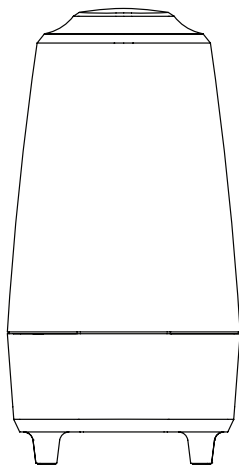

Subwoofer



Subwoofer power cord



6' AUX cable

Connecting Your MagniFi Mini to Your TV

1a. Is an HDMI input jack on your TV labeled “ARC”?

YES

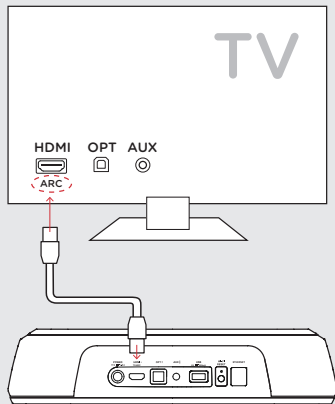

Use the provided
HDMI cable to connect the
sound bar to the TV.

NO

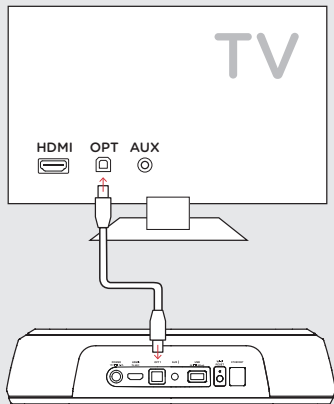

Use the provided
Optical cable to connect the
sound bar to the TV.

***You MUST have an HDMI ARC input on your TV to use HDMI.**

- 1b.** Don't have HDMI or Optical input available on your TV?

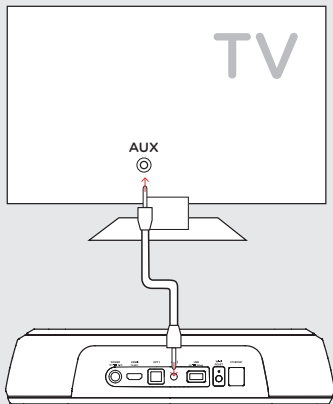

If your TV does not have an HDMI ARC or optical output, connect the sound bar to the TV with the provided **AUX cable**.

(Only HDMI and optical inputs support Dolby 5.1 decoding)

- 2.** Remote battery installation

Insert the provided AAA batteries.

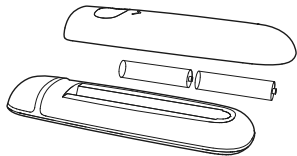

- 3.** Connect the sound bar power cord to an AC outlet

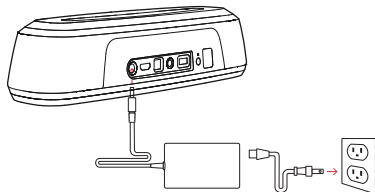

A red LED will pulse on the front of the sound bar indicating boot up.

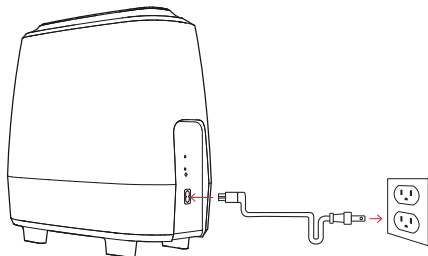
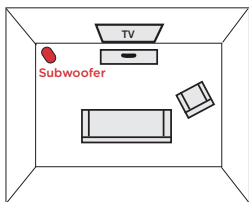

- 4. Position subwoofer and connect to an AC outlet**
(for best performance place on the same wall as the TV)



NOTE: The MagniFi Mini sound bar and wireless subwoofer are preset at the factory to work together. Should your wireless subwoofer stop receiving an audio signal, follow these instructions to re-establish the connection:

1. Turn on your sound bar. On the sound bar simultaneously press and hold the *Bluetooth* button  and the source button  for 3 seconds.
2. Press and hold the SYNC button on the back of the subwoofer for 3 seconds.
3. The green LED on the back of the subwoofer will start flashing at a faster rate, indicating that the sound bar and the subwoofer are connecting, the LED is solid green when connected.

- 5. Turn on your sound bar**

Press the Power button  on the sound bar or remote.

NOTE: make sure TV internal speakers are off when using optical and aux inputs.

Remote Control

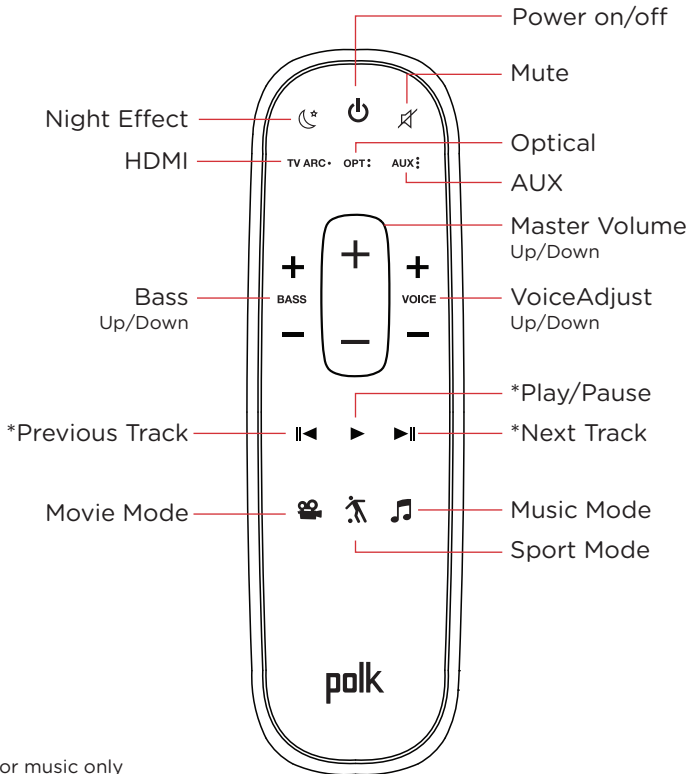

*For music only

Sound Bar Top Panel

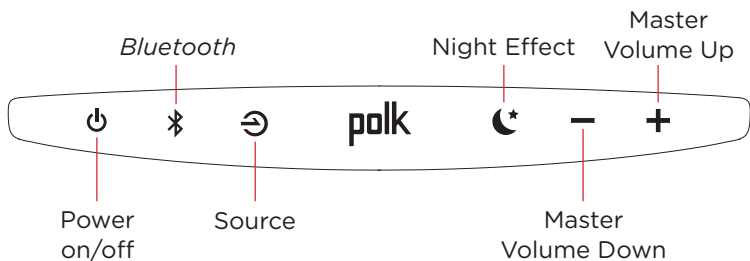

Sound Bar Back Panel

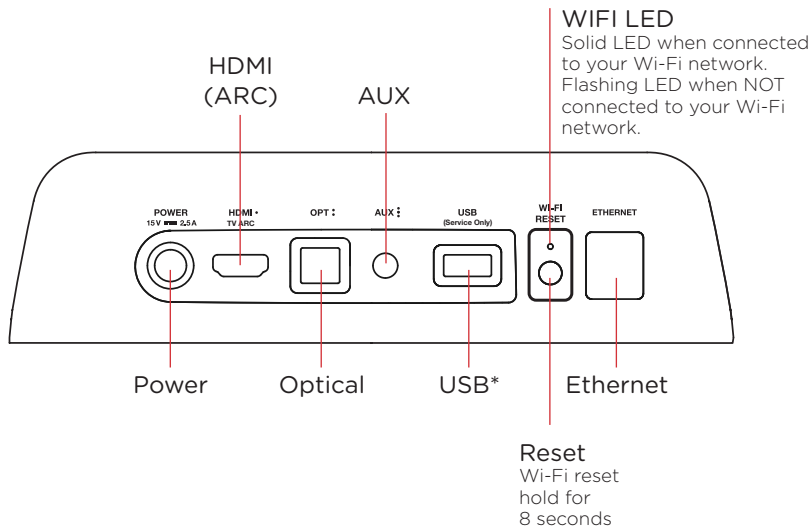

*Factory use only

Sound Bar LEDs

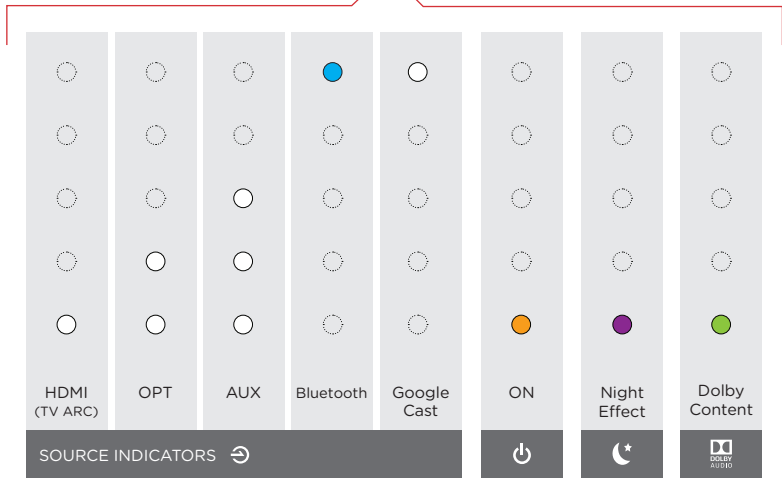
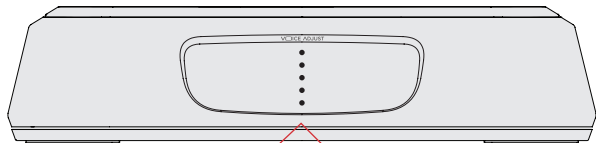

The MagniFi Mini has a vertical row of LED lights that provide status indications, like source, volume and listening modes.



Using Your TV or Cable/Satellite Remote (IR only) to Control the MagniFi Mini

The MagniFi Mini works best with the included remote, however you can also teach it to respond to your favorite TV or cable IR remote by following these steps:

IMPORTANT: Hold both remotes about 12" (30cm) directly in front of the MagniFi Mini when pressing their respective buttons, make sure you wait at least 1 second between button presses, make sure your remotes have fresh batteries

1. Enter learn mode by pressing and holding the  Source button on the sound bar until you hear a tone and the lights on the front of the sound bar pulse up and down.
2. Press and release the button on the MagniFi Mini remote that you want to learn (ex: Volume Up).
3. Press and Release the corresponding button on YOUR remote repeatedly until you hear a two note ascending tone.
NOTE: Make sure you wait at least 1 second between button presses!
4. Repeat steps 2 and 3 to learn Volume Down, Mute, and Power buttons from your remote.
5. Exit learn mode by pressing and holding the  Source button on the sound bar again until you hear a tone and the lights on the front of the sound bar stop pulsing.
6. Verify that your remote can control the buttons you programmed (ex: Volume up) on the MagniFi Mini.

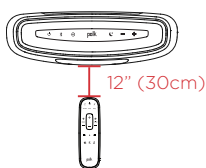

NOTE:

- You will hear a different (descending) tone if the command failed to learn. Please try again.
- MagniFi Mini will exit Learn mode after 1 minute of in activity, saving any learned codes

Optimizing Your Listening Experience

Bass Control

Control Bass Volume Levels

Easily adjust bass volume for more or less impact.

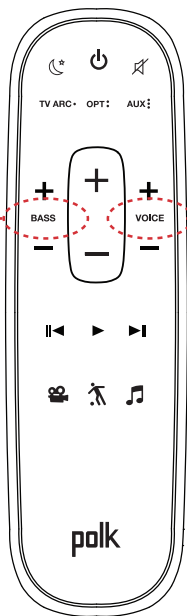
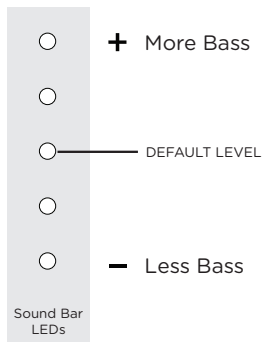

VOICE ADJUST™

Control Dialogue Volume Levels

Isolate and adjust the voice channel level to reproduce clear, crisp dialogue.

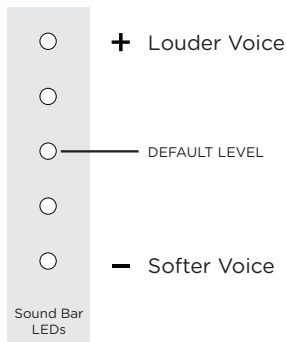



Movie Mode

Enhances audio reproduction in TV and movies.



Music Mode

Enhances audio whenever you're listening to music, or watching TV or movies that have music playing in them.



Sport Mode

Enhances audio whenever you're watching sporting events, news and talk shows.



Night Effect

Reduces bass and volume dynamics while improving voice intelligibility for low-volume listening.

Music Services

How to Set Up Google Cast™

1. Power on the sound bar.
2. From your phone, tablet or computer visit:
chromecast.com/setup
3. Download the Google Home app, click on the devices tab within the app and select MagniFi Mini. Follow in app setup instructions.



4. When you're streaming Google Cast, a white LED will appear on the sound bar.

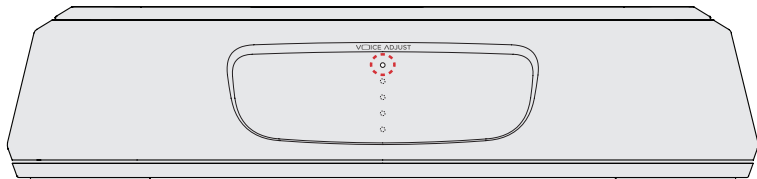

How to hear your TV again: When you are finished using Google Cast, press the source button on the sound bar or remote (TV ARC, OPT, AUX).

How to Set Up *Bluetooth*[®]

1. To enable *Bluetooth*, press the *Bluetooth* button  on the sound bar. A blue LED will slowly pulse on the sound bar.

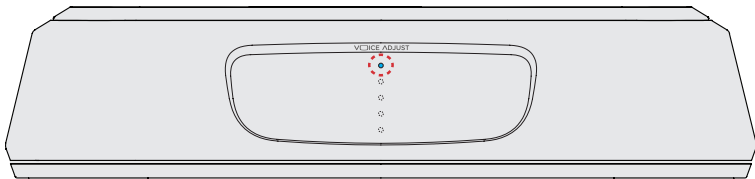

2. Go to the *Bluetooth* devices section on your phone, tablet or computer and select Polk MagniFi Mini. The LED is solid blue when *Bluetooth* is connected.

Note: To take control when another device is connected, press the *Bluetooth* button.

How to hear your TV again: When you are finished using *Bluetooth*, press the source button on the sound bar or remote (TV ARC, OPT, AUX).

Merci de votre achat d'un produit Polk. Pour toute question ou tout commentaire, veuillez nous appeler ou nous écrire par courriel sans hésiter.

Assistance technique

En Amérique du Nord, appelez le service à la clientèle de Polk au **800-377-POLK(7655)** (L-V, 9 h - 17 h 30 HNE)

Hors des É.-U., appelez au **+1-410-358-3600**

courriel **polkcs@polkaudio.com**

Polk Audio
1 Viper Way, Vista, CA 92081

Le manuel du propriétaire complet est disponible en ligne à **www.polkaudio.com**

Dans la boîte

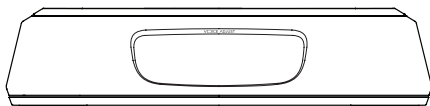

Barre de son



Télécommande



Batteries

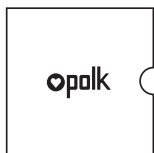

Littérature



Barre de son
cordon
d'alimentation

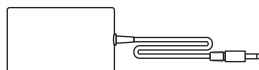

Alimentation de la
barre sonore



Câble HDMI de
6,5 pi (2 m)

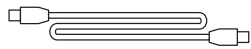

Câble optique
de 6 pi (1,8 m)

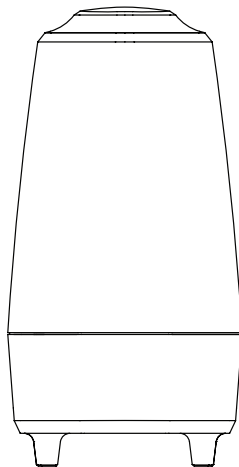

Caisson d'extrêmes
graves sans-fils



Subwoofer cordon
d'alimentation



Câble AUX de
6 pi (1,8 m)

Connexion votre MagniFi Mini à votre télé

- 1a. Est-ce qu'un un connecteur d'entrée HDMI sur votre télé est nommé «ARC»?

OUI

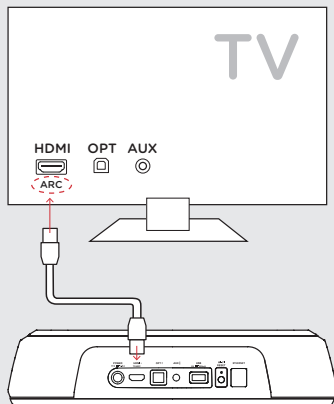

Utilisez le **câble HDMI** fourni pour connecter la barre de son à la télé.

NON

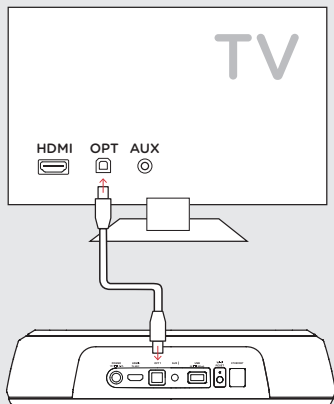

Utilisez le **câble optique** fourni pour connecter la barre de son à la télé.

*Vous **DEVEZ** avoir une entrée **HDMI ARC** sur votre télé pour utiliser le HDMI.

- 1b.** Vous n'avez pas d'entrée HDMI ou optique disponible sur votre télé?

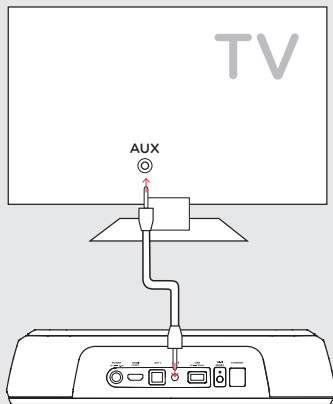

Si votre télé n'a pas d'entrée HDMI ARC ou optique, connectez la barre de son à la télé avec le **câble AUX** fourni.

(Seules les entrées HDMI et optiques sont compatibles pour le décodage Dolby 5.1)

- 2.** Installation des piles de la télécommande

Insérer les piles AAA fournies.

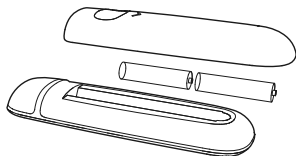

- 3.** Connecter le cordon d'alimentation barre de son the sound bar power cord to an AC outlet

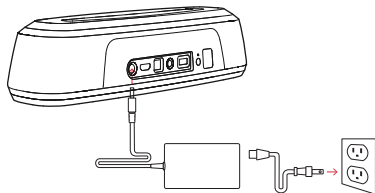

Un indicateur à DEL rouge clignotera à l'avant de la barre de son pour indiquer la phase de réchauffement.

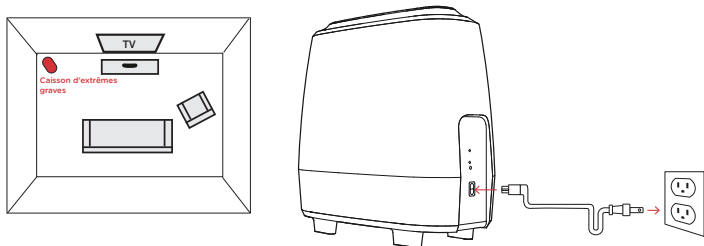

- 4. Positionnement du caisson d'extrêmes graves et connexion à une prise de courant** (pour de meilleures performances, placez-le sur le même mur que la télé)



NOTE : La barre de son MagniFi Mini et le caisson d'extrêmes graves sans fil sont configurés à l'usine pour fonctionner ensemble. Si votre caisson d'extrêmes graves cesse de recevoir le signal audio, suivez ces instructions pour rétablir la connexion:

1. Allumez votre barre de son. Sur la barre de son, appuyez simultanément et tenez le bouton *Bluetooth*  et le bouton *Source*  pendant 3 secondes.
2. Appuyez et tenez le bouton *SYNC* à l'arrière du caisson d'extrêmes graves pendant 3 secondes.
3. La DEL verte à l'arrière du caisson d'extrêmes graves commencera à clignoter à un rythme plus rapide indiquant que la barre de son et le caisson d'extrêmes graves se connectent la DEL est verte en continu lorsque celui-ci est connecté.

- 5. Allumez votre barre de son**
Appuyez sur le bouton de mise sous tension  sur la barre de son ou la télécommande.

Note : assurez-vous que les haut-parleurs internes de la télévision sont éteints lorsque vous utilisez les entrées optique et auxiliaire.

Télécommande

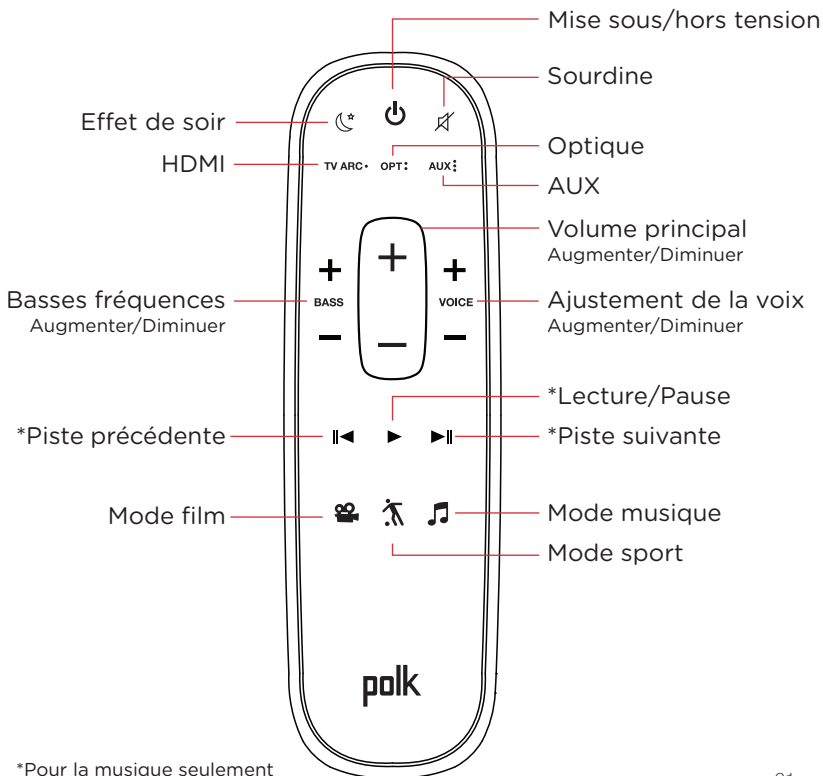

*Pour la musique seulement

Panneau supérieur de la barre de son

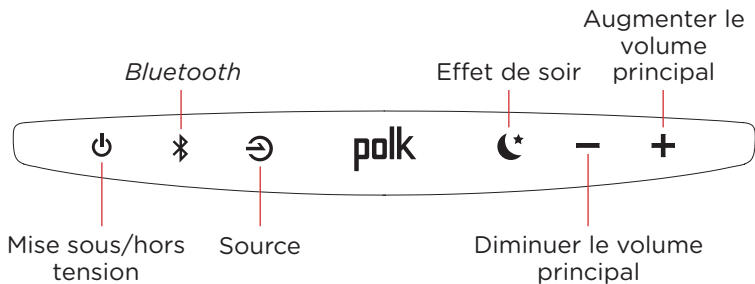

Panneau arrière de la barre de son

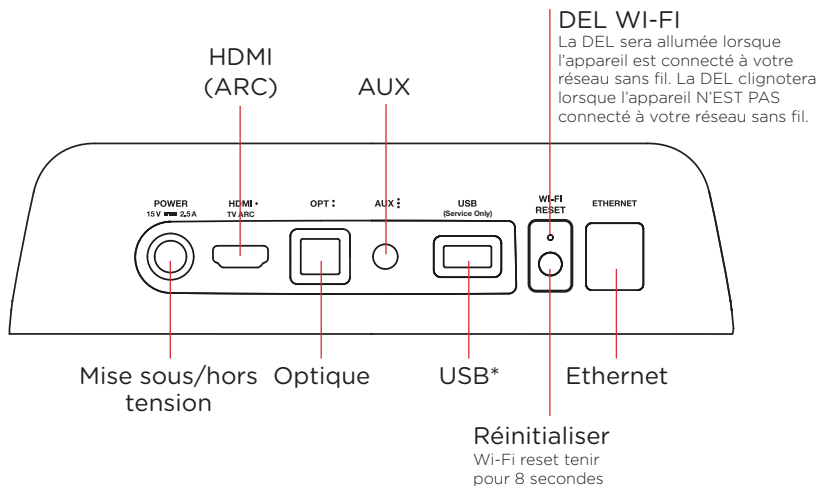

*Utilisation en usine seulement

Indicateurs à DEL de la barre de son

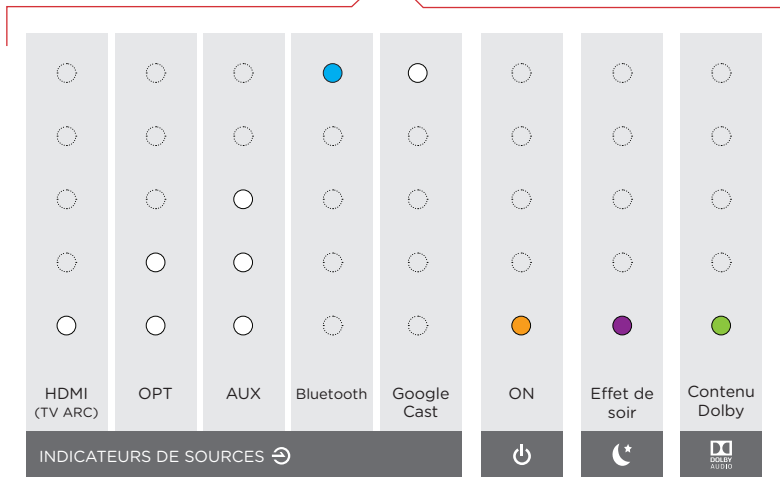
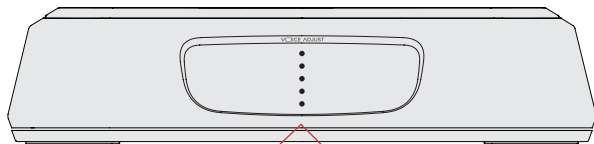

Le MagniFi Mini comporte une colonne d'indicateurs à DEL qui fournit des indications de statut, comme la source, le volume et les modes d'écoute.



Utilisez votre Télécommande de TV ou de câble pour contrôler le MagniFi Mini

Le MagniFi Mini fonctionne mieux avec la télécommande fournie, cependant, vous pouvez aussi le programmer pour fonctionner avec votre télécommande Infrarouge de TV ou de câble en suivant les étapes suivantes :

IMPORTANT : Tenez les deux télécommandes à environ 30 cm (12") du MagniFi Mini tout en appuyant sur leur bouton respectif., Assurez-vous d'attendre au moins 1 seconde entre chaque utilisation d'un bouton, Assurez-vous que les batteries des télécommandes sont neuves.

1. Entrez dans le mode Apprentissage en restant appuyé sur le bouton **Source**  de la barre jusqu'à ce que vous entendiez un son et que les lumières situées sur la façade de la barre de son clignotent.
2. Appuyez sur le bouton de la télécommande du MagniFi Mini que vous souhaitez apprendre (ex : monter le son).
3. Pressez et relâchez le bouton correspondant sur VOTRE TÉLÉCOMMANDE à plusieurs reprises jusqu'à ce que vous entendiez deux sons. REMARQUE : Assurez-vous d'attendre au moins 1 seconde entre chaque pression !
4. Répétez les étapes 2 et 3 pour programmer les fonctions des boutons « Baisser le son », « Couper le Son » et « Allumer/Éteindre » de votre télécommande.
5. Sortez du mode apprentissage en restant appuyé sur le bouton **Source**  de la barre de son jusqu'à ce que vous entendiez un son et que les lumières situées sur la façade de la barre de son ne clignotent plus.
6. Vérifiez que votre télécommande contrôle bien les boutons que vous avez programmés (ex : monter le son) sur le MagniFi Mini.

REMARQUES :

- Vous entendrez un son différent (descendant) si la commande n'a pas été apprise. Veuillez alors réessayer.
- Le MagniFi Mini quittera le mode Apprentissage au bout d'une minute d'inactivité et enregistrera les codes appris.

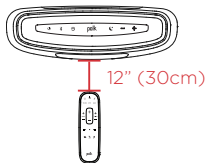

Optimisation de votre expérience d'écoute

Contrôle des basses fréquences

Contrôlez le volume des basse fréquences

Réglez facilement le volume de la basse pour plus ou moins d'impact.

+ Volume des basses plus élevé



NIVEAU PAR DÉFAUT



- Volume des basses moins élevé

Indicateurs à DEL de la barre de son

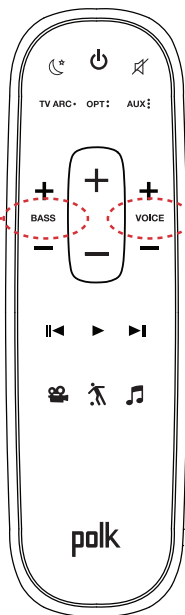

VOICE ADJUST™

Contrôlez le volume des dialogues

Isolez et ajustez le canal de la voix afin de reproduire des dialogues clairs et nets.

+ Volume de la voix plus élevé



NIVEAU PAR DÉFAUT



- Volume de la voix plus bas

Indicateurs à DEL de la barre de son



Mode film

Améliore la reproduction audio pour la télé et les films.



Mode musique

Améliore l'audio lorsque vous écoutez de la musique ou que vous regardez la télé ou visionnez un film contenant de la musique.



Mode sport

Améliore l'audio lorsque vous regardez des événements sportifs, les nouvelles et des émissions d'interview-variétés.



Effet de soir

Réduit les basses et la dynamique du volume tout en améliorant l'intelligibilité de la voix pour les écoutes à bas volume.

Services de musique

Comment configurer Google Cast™

1. Allumez la barre de son.
2. À partir de votre téléphone, tablette ou ordinateur, visitez : chromecast.com/setup
3. Téléchargez l'appli Cast, cliquez sur l'onglet des appareils dans l'appli et sélectionner MagniFi Mini. Suivez les intructions de configuration dans l'appli.



4. Lorsque vous diffusez en continu via Google Cast, une DEL blanche apparaît sur la barre de son.

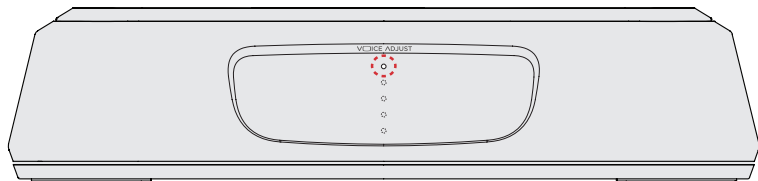

Comment entendre votre télé de nouveau : Lorsque vous avez terminé d'utiliser Google Cast, appuyez sur le bouton source sur la barre de son ou sur la télécommande (TV ARC, OPT, AUX).

Comment configurer le *Bluetooth*[®]

1. Pour activer le *Bluetooth*, appuyez sur le bouton *Bluetooth*  sur la barre de son. Une DEL bleue clignotera lentement sur la barre de son.

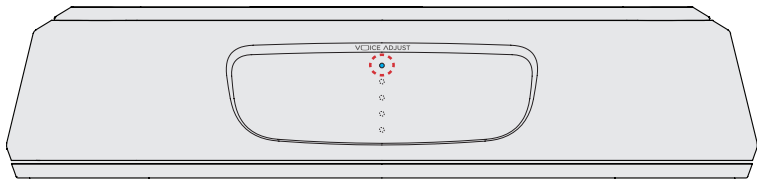

Allez dans la section des appareils *Bluetooth* de votre téléphone, tablette ou ordinateur et sélectionnez Polk MagniFi Mini. La DEL bleue s'allume alors en continu lorsque le *Bluetooth* est connecté.

Note : pour prendre le contrôle lorsqu'un autre dispositif est connecté, appuyez sur le bouton *Bluetooth*.

Comment entendre votre télé de nouveau : Lorsque vous avez terminé d'utiliser Google Cast, appuyez sur le bouton source sur la barre de son ou sur la télécommande (TV ARC, OPT, AUX).

Gracias por su compra de Polk. Si tiene alguna duda o comentario, por favor, llame o envíenos un e-mail.

Asistencia técnica

En Norteamérica, llame al servicio de atención al cliente de Polk:

800-377-POLK(7655) (L-V, 9 a.m.-5:30 p.m. EST)

Desde fuera de EE. UU., llame al **+1-410-358-3600**

e-mail **polkcs@polkaudio.com**

Polk Audio

1 Viper Way, Vista, CA 92081

El manual de usuario completo puede verse online en

www.polkaudio.com

Qué hay en la caja

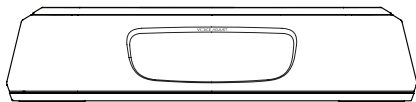

Barra de sonido



Mando a distancia



Pilas

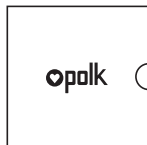

Literatura



Cable de alimentación princip.

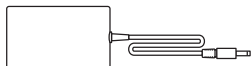

Suministro eléctrico princip.



Cable 2 m HDMI



Cable óptico 1,8 m

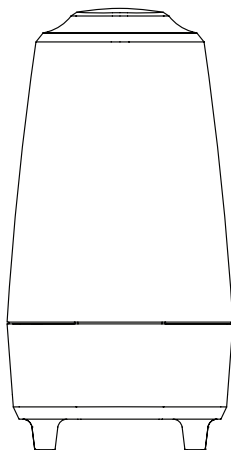

Subwoofer

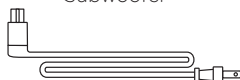

Cable de alim. subwoofer



Cable AUX 1,8 m

Conectar el MagniFi Mini a la TV

1a. ¿Hay un puerto de HDMI en su TV llamado «ARC»?

SÍ

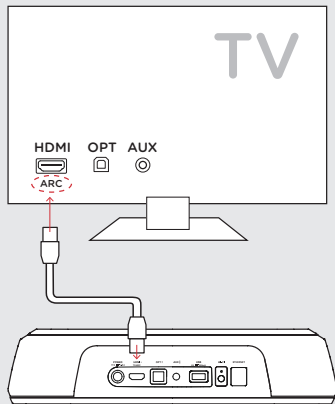

Use el **cable HDMI** incluido para conectar la barra de sonido a la TV.

NO

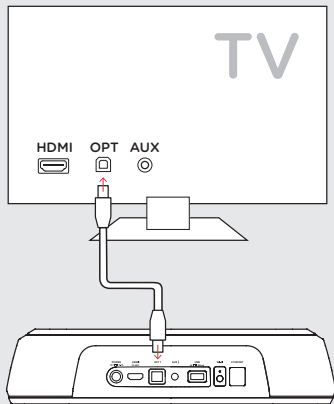

Use el **cable óptico** incluido para conectar la barra de sonido a la TV.

***DEBE tener un puerto HDMI ARC en la TV para usar HDMI.**

- 1b.** ¿No tiene un puerto HDMI u óptico disponible en su TV?

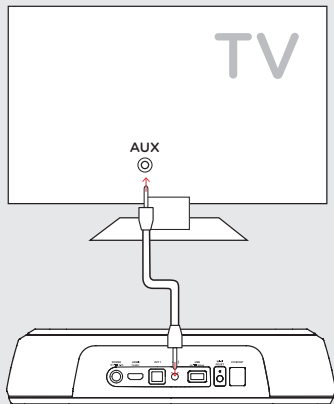

Si su TV no tiene un puerto HDMI ARC u óptico, conecte la barra a la TV con el **cable AUX** proporcionado.

(Tan solo las entradas HDMI y las ópticas soportan decodificación Dolby 5.1)

- 2.** Instalar las pilas del mando

Inserte las pilas AAA incluidas.

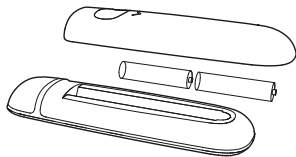

- 3.** Conecte el cable eléc. de la barra de sonido al enchufe

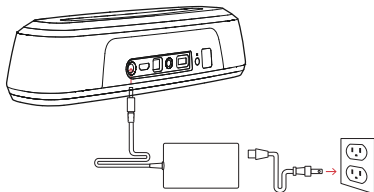

Parpadeará una luz LED roja en la parte frontal de la barra de sonido (calentam.).

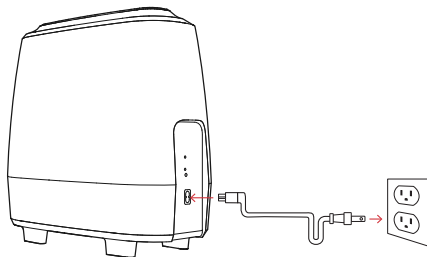
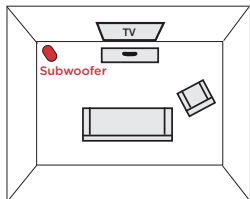

- 4. Coloque el subwoofer y conecte al enchufe**
(para un mejor rendim., coloque en la misma pared que TV)



NOTA: la barra de sonido MagniFi Mini y el subwoofer inalámbrico están preajustadas para funcionar al mismo tiempo. En caso de que el subwoofer inalámbrico dejara de recibir una señal de audio, siga estas instrucciones para reestablecer la conexión:

1. Encienda su barra de sonido. En la barra de sonido, presione simultáneamente y mantenga apretados los botones de *Bluetooth*  y el botón de la fuente  durante 3 segundos.
2. Presione y mantenga apretado el botón SYNC en la parte trasera del subwoofer durante 3 segundos.
3. El LED verde en la parte trasera del subwoofer empezará a parpadear más rápidamente, lo que indica que la barra de sonido y el subwoofer están conectando, el LED será verde y fijo cuando estén conectados.

- 5. Encienda la barra de sonido**

Presione Power  en la barra de sonido o mando a dist.

Nota: asegúrese de que los altavoces internos de su TV estén apagados cuando utilice entradas ópticas y auxiliares.

Mando a distancia

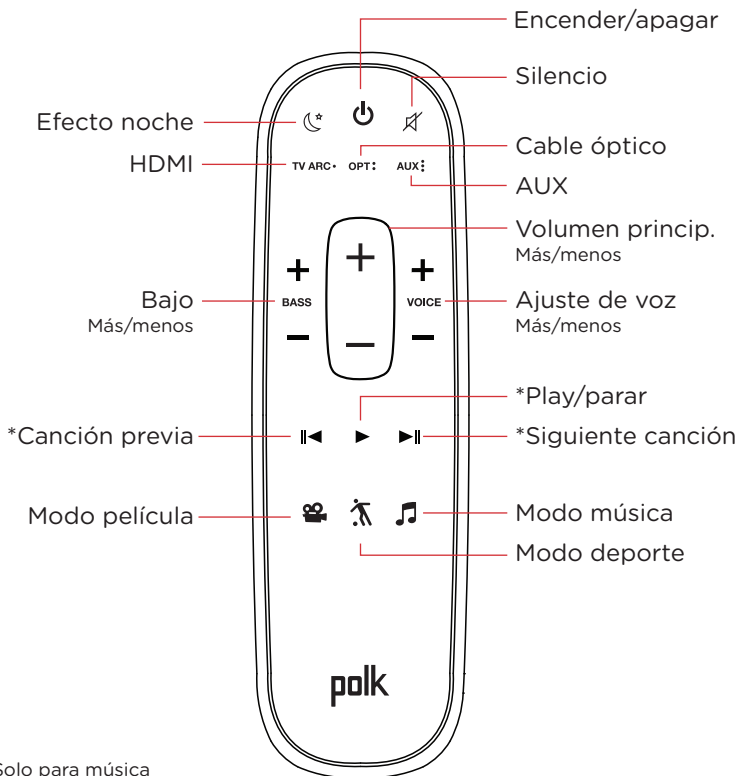

*Solo para música

Panel superior de la barra de sonido

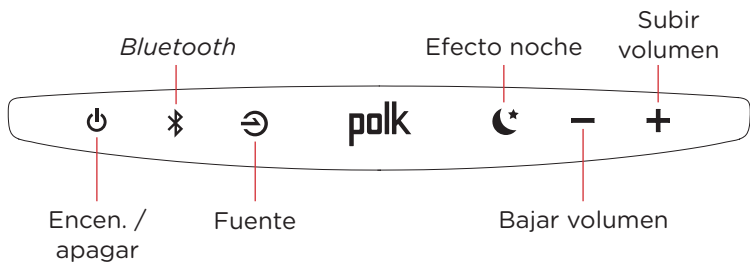

Panel trasero de la barra de sonido

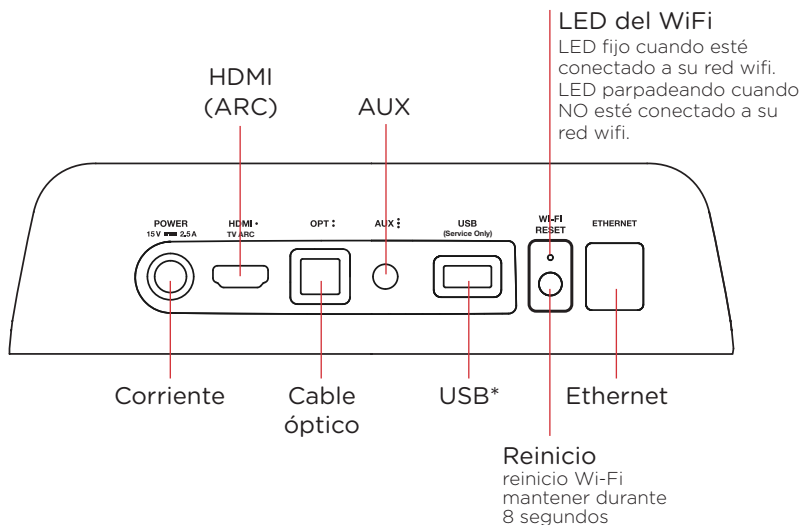

*Solo uso en fábrica

LEDs de la barra de sonido

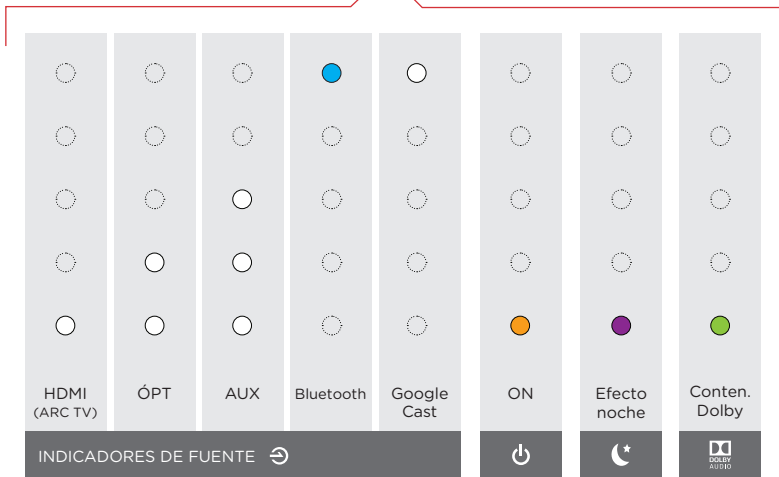
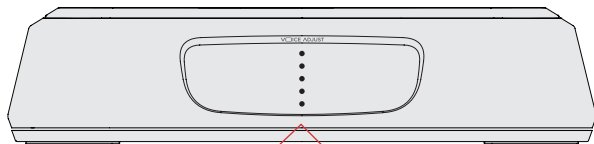

MagniFi Mini tiene una fila vertical de LEDs que informan del estado, como la fuente, el volumen y los modos de escucha.



Uso de su control remoto de TV o cable para operar el MagniFi Mini

El MagniFi Mini funciona mejor con el control remoto incluido, aunque también puede enseñarle a responder a su control remoto IR de TV o de cable siguiendo estos pasos:

IMPORTANTE: Sostenga ambos controles remotos a unos 12" (30 cm) directamente enfrente del MagniFi Mini y pulse sus botones respectivos, Asegúrese de esperar al menos 1 segundo entre pulsar un botón y el otro, Asegúrese de que ambos controles remotos tienen pilas nuevas.

1. Entre en el modo de aprendizaje pulsando y manteniendo pulsado el botón de Fuente  (Source) en la barra de sonido hasta que escuche un tono y las luces enfrente de la barra de sonido se enciendan arriba y abajo.
2. Pulse y suelte el botón del control remoto MagniFi Mini que desee aprender (p. ej., subir el volumen).
3. Pulse y suelte el botón correspondiente en SU control remoto repetidamente hasta que escuche un tono ascendente de dos notas. **NOTA:** ¡Asegúrese de esperar al menos 1 segundo entre pulsar un botón y el otro!
4. Repita los pasos 2 y 3 para aprender los botones de bajar el volumen, silenciar y de encendido de su control remoto.
5. Salga del modo de aprendizaje pulsando y manteniendo pulsado el botón de Fuente  (Source) en la barra de sonido de nuevo hasta que escuche un tono y las luces enfrente de la barra de sonido dejen de encenderse.
6. Verifique que su control remoto puede operar los botones que ha programado (p. ej., subir el volumen) en el MagniFi Mini.

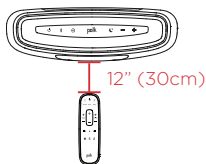

NOTA:

- Escuchará un tono diferente (descendente) si el comando no ha aprendido. Por favor, inténtelo de nuevo.
- MagniFi Mini saldrá del modo de aprendizaje tras 1 minuto de inactividad, guardando cualquier código aprendido.

Optimice su experiencia de escucha

Control de bajo

Controle el volumen de bajo

Ajuste de volumen de bajo fácil para más o menos impacto.

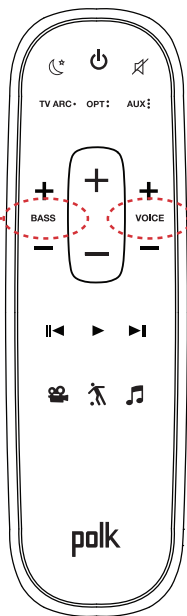
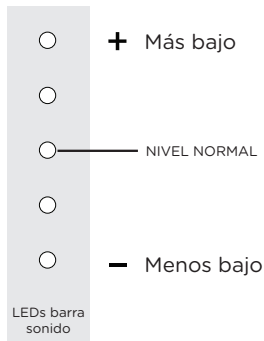

VOICE ADJUST™

Controle el volumen de los diálogos

Separe y ajuste el nivel del canal de voz para reproducir un diálogo claro y nítido.

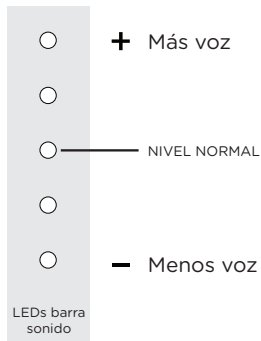



Modo película

Mejora la reproducción de audio en TV y películas.



Modo música

Mejora el audio cuando esté escuchando música o viendo la TV o películas que tienen música en ellas.



Modo deporte

Mejora el audio cuando esté viendo eventos deportivos, noticias y talk shows.



Efecto noche

Reduce el bajo y las dinámicas de volumen mientras mejora la inteligibilidad de la voz para una escucha a volumen bajo.

Servicios de música

Cómo configurar Google Cast™

1. Encienda la barra de sonido.
2. Desde su teléfono, tableta u ordenador visite:
chromecast.com/setup
3. Descargue la aplicación Cast, haga clic en la pestaña de dispositivos en la aplicación y seleccione MagniFi Mini. Siga las instrucciones de configuración de la aplicación.



4. Cuando esté reproduciendo Google Cast, un LED blanco aparecerá en la barra de sonido.

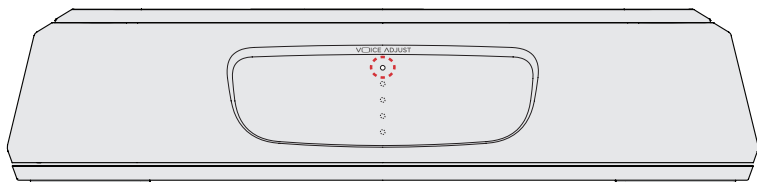

Cómo volver a oír la TV: cuando haya acabado de usar Google Cast, presione el botón de fuente en la barra de sonido o el mando a dist. (TV ARC, OPT, AUX).

Cómo configurar el *Bluetooth*[®]

1. Para activar el *Bluetooth*, presione el botón de *Bluetooth*  en la barra de sonido. Una LED azul parpadeará despacio en la barra.

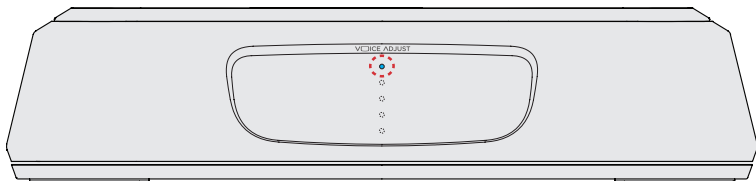

2. Vaya a la sección de dispositivos *Bluetooth* de su móvil, tableta u ordenador y seleccione MagniFi Mini. La LED será azul fijo cuando el *Bluetooth* esté conectado.

Nota: para tomar el control cuando otro dispositivo esté conectado, pulse el botón *Bluetooth*.

Cómo oír su TV de nuevo: Cuando haya acabado con el *Bluetooth*, apriete el botón de fuente en la barra de sonido o el mando a distancia (TV ARC, ÓPT, AUX).

Vielen Dank, dass Sie sich für ein Produkt von Polk entschieden haben. Sollten Sie Fragen zu Ihrem Gerät haben, nehmen Sie bitte per Telefon oder E-Mail mit uns Kontakt auf.

Technische Fragen

In Nordamerika bitte den Polk-Kundendienst unter folgender Nummer anrufen

800-377-POLK(7655) (Mo. bis Fr. zwischen 9:00 und 17:30 Uhr EST)

Außerhalb der USA bitte folgende Nummer anrufen
+1-410-358-3600

oder eine E-Mail schicken an: **polkcs@polkaudio.com**

Polk Audio
1 Viper Way, Vista, CA 92081
USA

Die vollständige Bedienungsanleitung finden Sie im Internet unter:
www.polkaudio.com

LIEFERUMFANG

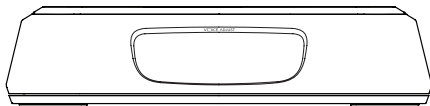

Soundbar



Fernbedienung



Batterie

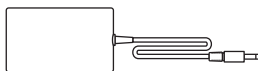
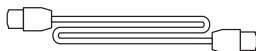

Literatur

Soundbar
elektrische anschlusskabelSoundbar
Stromversorgung

6,5' (2m) HDMI-Kabel

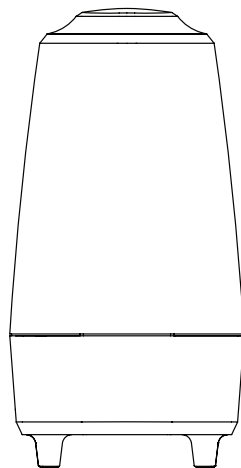
6' (1,8m) Optisches
Verbindungskabel

Drahtloser Subwoofer

Subwoofer elektrische
anschlusskabel

6' (1,8m) AUX-Kabel

So schließen Sie Ihr MagniFi Mini an Ihren Fernseher an

- 1a. Befindet sich an Ihrem Fernsehgerät ein HDMI-Eingang mit der Beschriftung **ARC**?

JA

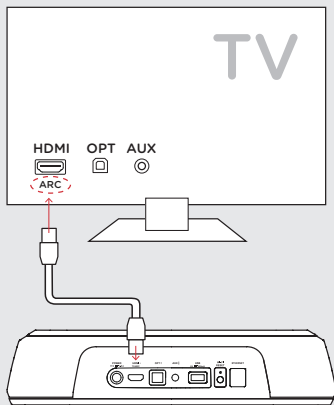

Verwenden Sie das mitgelieferte **HDMI-Kabel**, um die Soundbar an Ihren Fernseher anzuschließen.

NEIN

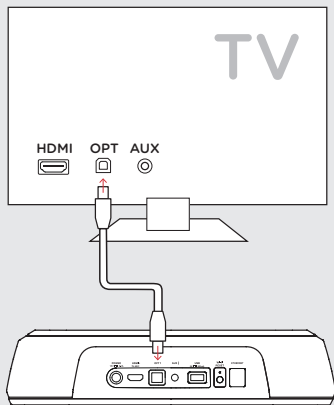

Verwenden Sie das mitgelieferte **optische Kabel**, um die Soundbar an Ihren Fernseher anzuschließen.

*UM HDMI nutzen zu können, **MUSS** Ihr Gerät über einen **HDMI ARC**-Eingang verfügen.

- 1b.** Ihr Fernsehgerät ist nicht mit einem HDMI- oder optischen Eingang ausgestattet?

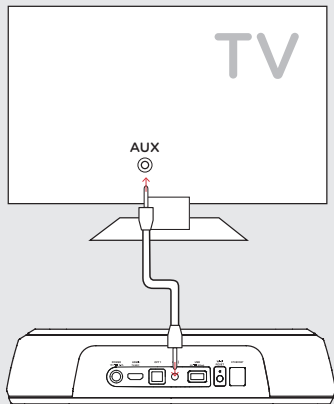

Wenn Ihr Fernsehgerät über keinen HDMI-ARC oder optischen Ausgang verfügt, schließen Sie die Soundbar mit dem mitgelieferten **AUX-Kabel** an den Fernseher an.

(Nur HDMI und optische Eingänge unterstützen Dolby 5.1-Dekodierung)

- 2.** Batterien in Fernbedienung einsetzen

Setzen Sie die mitgelieferten AAA-Batterien ein.

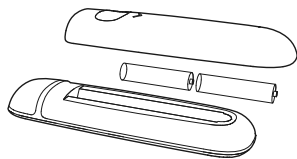

- 3.** Das Netzkabel der Soundbar an die Steckdose anschließen

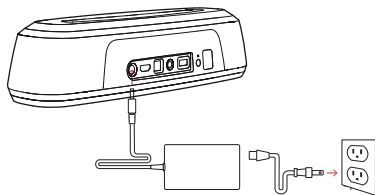

Auf der Vorderseite der Soundbar blinkt eine rote LED auf. Dies bedeutet, dass sich das Gerät in der Aufwärmphase befindet.

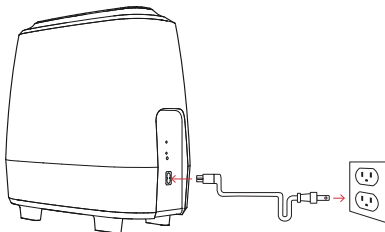
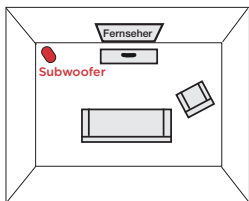

- 4. Den Subwoofer aufstellen und an eine Steckdose anschließen**
(beste Klangergebnisse erzielen Sie, wenn das Gerät an derselben Wand wie der Fernseher aufgestellt wird)



HINWEIS: Die MagniFi Mini Soundbar und der drahtlos verbundene Subwoofer werden werkseitig so voreingestellt, dass sie miteinander kommunizieren. Sollte Ihr Subwoofer das drahtlos übertragene Audiosignal nicht empfangen, befolgen Sie bitte folgende Anweisungen, um die Verbindung wieder herzustellen:

1. Schalten Sie Ihre Soundbar ein. Drücken auf der Soundbar gleichzeitig die *Bluetooth*-Taste  und die *Quelle*-Taste  und halten Sie beide Tasten 3 Sekunden lang gedrückt.
2. Drücken Sie die *SYNC*-Taste auf der Rückseite des Subwoofers und halten Sie diese 3 Sekunden lang gedrückt.
3. Daraufhin beginnt die grüne LED auf der Rückseite des Subwoofers schneller zu blinken, womit angezeigt wird, dass die Verbindung zwischen Soundbar und Subwoofer aufgebaut wird. Sobald die Verbindung steht, leuchtet die LED dauerhaft grün.

5. Ihre Soundbar einschalten

Drücken Sie auf den Ein/Aus-Schalter  auf der Soundbar oder der Fernbedienung. Hinweis: Stellen Sie sicher, dass TV-interne Lautsprecher ausgeschaltet sind, wenn optische und Aux-Eingänge verwendet werden.

Fernbedienung

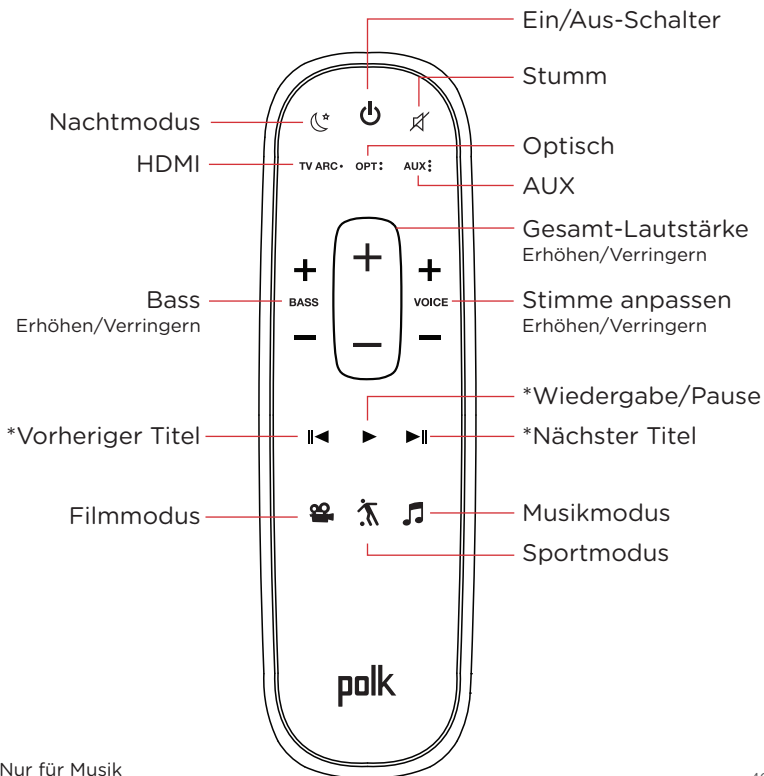

*Nur für Musik

Bedienelemente auf der Oberseite der Soundbar

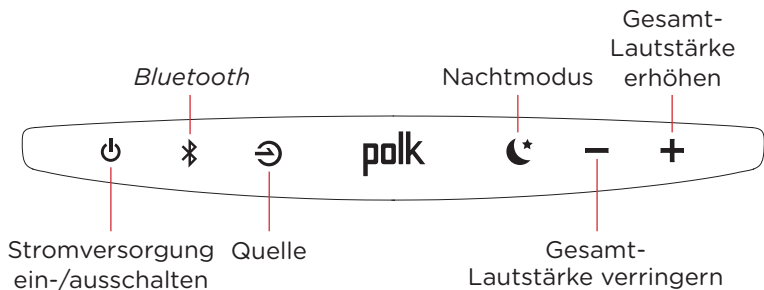

Anschlüsse und Bedienelemente auf der Rückseite der Soundbar

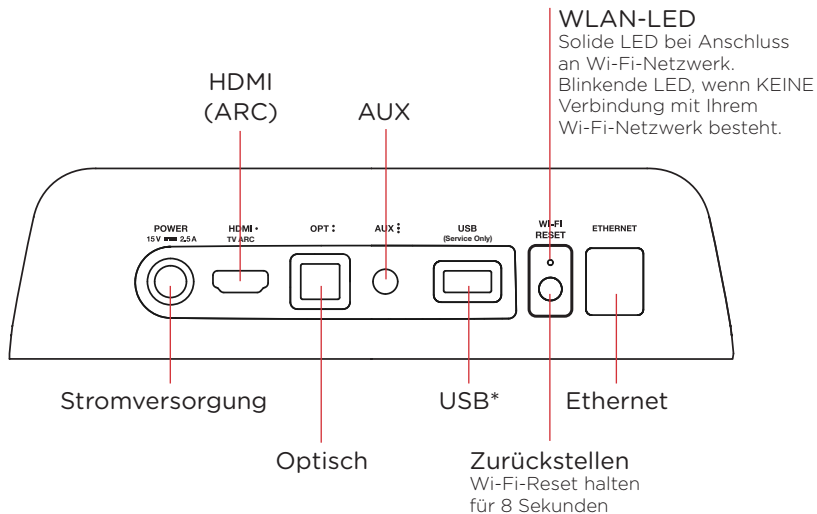

*Wird nur im Werk verwendet

LEDs der Soundbar

MagniFi Mini verfügt über eine Reihe vertikal angebrachter LEDs, über die bestimmte Statusmeldungen für die Quelle, Lautstärke, Wiedergabemodi usw. angezeigt werden.

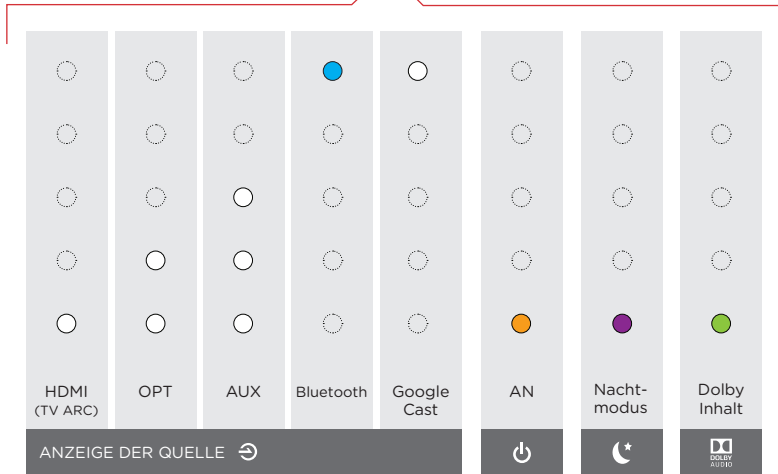

Die Verwendung Ihrer TV- oder Kabelfernbedienung zur Steuerung der MagniFi Mini

Die MagniFi Mini funktioniert am besten mit der mitgelieferten Fernbedienung, aber Sie können sie auch so einstellen, dass sie auf Ihre Lieblings-TV- oder Kabel-IR-Fernbedienung reagiert, indem Sie die folgende Schritte ausführen:

WICHTIG: Halten Sie beide Fernbedienungen im Abstand von 12" (30 cm) vor die MagniFi Mini, wenn Sie die entsprechenden Tasten drücken, Stellen Sie sicher, dass Sie zwischen dem Drücken der Tasten mindestens 1 Sekunde warten, Vergewissern Sie sich, dass Ihre Fernbedienungen frische Batterien haben

1. Geben Sie den Lernmodus ein, indem Sie die  Source-Taste auf der Soundbar gedrückt halten, bis Sie einen Ton hören und die Lichter an der Vorderseite der Soundbar nach oben und unten pulsieren.
2. Drücken Sie kurz die Taste der MagniFi Mini-Fernbedienung, die Sie einstellen möchten [z. B. „Volume Up“ (Lautstärke erhöhen)] und lassen Sie diese wieder los.
3. Drücken Sie wiederholt die entsprechende Taste auf IHRER Fernbedienung, bis ein zweifach aufsteigender Ton ertönt, und lassen Sie diese wieder los. HINWEIS: Warten Sie mindestens 1 Sekunde zwischen dem Drücken der Tasten!
4. Wiederholen Sie die Schritte 2 und 3, um die Tasten „Volume Down“ (Lautstärke reduzieren), „Mute“ (Stummschaltung) und „Power“ einzustellen.
5. Beenden Sie den Lernmodus, indem Sie die  Source-Taste auf der Soundbar erneut drücken, bis Sie einen Ton hören und die Lichter an der Vorderseite der Soundbar aufhören zu pulsieren.
6. Vergewissern Sie sich, dass Ihre Fernbedienung die von Ihnen programmierten Tasten (z. B. Lautstärke erhöhen) am MagniFi Mini steuern kann.

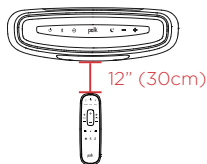

ACHTUNG:

- Sie hören einen anderen (absteigenden) Ton, wenn der Befehl fehlgeschlagen ist. Bitte versuchen Sie es erneut.
- Die MagniFi Mini beendet den Lernmodus nach einer Minute Inaktivität und speichert alle erlernten Codes.

Optimierung des Hörerlebnisses

Tiefenregelung

Lautstärke der Bässe einstellen

Je nach Geschmack mehr oder weniger Bassklang einstellen.

- + Mehr Bass
- STANDARD-NIVEAU
- Weniger Bass

LEDs der Soundbar

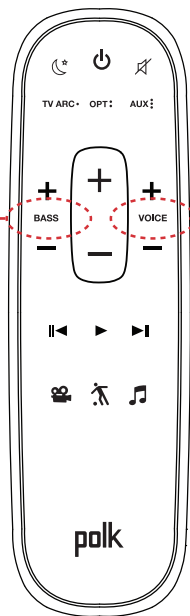

VOICE ADJUST™

Lautstärke der Sprechstimmen einstellen

Den Sprachkanalpegel isolieren und anpassen, um Dialoge glasklar zu hören.

- + Lautere Stimmen
- STANDARD-NIVEAU
- Leisere Stimmen

LEDs der Soundbar



Filmmodus

Bessere Audio-Wiedergabe bei Filmen und Fernsehprogrammen.



Musikmodus

Bessere Audio-Wiedergabe beim Hören von Musik oder beim Schauen von Filmen oder Fernsehprogrammen, in denen Musik gespielt wird.



Sportmodus

Bessere Audio-Wiedergabe beim Schauen von Sportereignissen, Nachrichten und Talkshows.



Nachtmodus

Weniger Bass- und Lautstärke-Dynamik bei gleichzeitiger Verbesserung der Sprachverständlichkeit bei geringer Gesamtlautstärke.

Musikdienste

Google Cast™ einstellen

1. Schalten Sie die Soundbar ein.
2. Rufen Sie mit dem Smartphone, Tablet oder Computer folgende Seite auf: chromecast.com/setup
3. Laden Sie die Cast-App herunter, tippen Sie in der App auf die Registerkarte Geräte und wählen Sie MagniFi Mini. Befolgen Sie die Einrichtungsanweisungen der App.



4. Das Streamen über Google Cast wird durch eine weiße LED auf der Soundbar angezeigt.

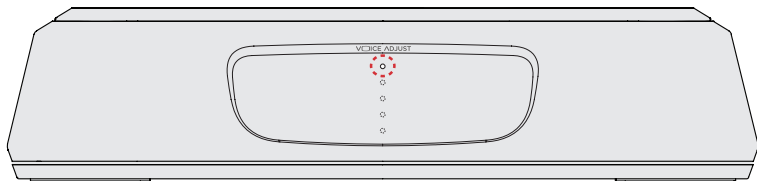

Wieder auf Audio-Wiedergabe des Fernsehers umschalten: Wenn Sie keine weiteren Inhalte über Google Cast hören möchten, drücken Sie die Quelle-Taste auf der Soundbar oder der Fernbedienung (TV ARC, OPT, AUX).

Bluetooth® einrichten

1. Drücken Sie zum Aktivieren von *Bluetooth* die entsprechende Taste  auf der Soundbar. Daraufhin beginnt auf der Soundbar eine blaue LED langsam zu blinken.

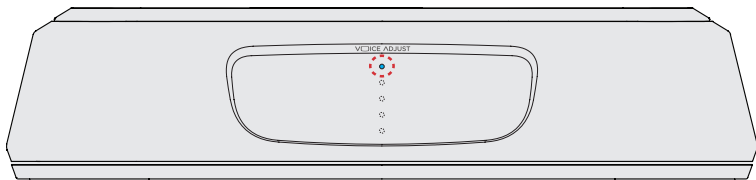

2. Öffnen Sie auf Ihrem Smartphone, Tablet oder Computer den Bereich zum Anbinden von *Bluetooth*-Geräten und wählen Sie Polk MagniFi Mini. Die LED leuchtet durchgehend blau, sobald eine *Bluetooth*-Verbindung besteht.

Hinweis: Um die Kontrolle zu übernehmen, wenn ein anderes Gerät angeschlossen ist, drücken Sie die *Bluetooth*-Taste.

Wieder auf Audio-Wiedergabe des Fernsehers umschalten: Wenn Sie keine weiteren Inhalte über die *Bluetooth*-Verbindung hören möchten, drücken Sie die Quelle-Taste auf der Soundbar oder der Fernbedienung (TV ARC, OPT, AUX).

Grazie per avere acquistato un prodotto Polk. Per qualsiasi domanda o commento non esitate a contattarci via telefono o email.

Assistenza tecnica

In Nord America, Chiama il Polk Customer Service al **800-377-POLK(7655)** (M-F, 9 a.m.-5:30 p.m. EST)

Fuori dagli USA, chiama il **+1-410-358-3600**

email **polkcs@polkaudio.com**

Polk Audio
1 Viper Way, Vista, CA 92081

Il manuale completo è disponibile online su **www.polkaudio.com**

Contenuto

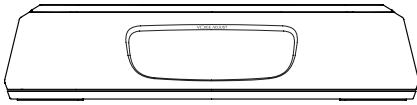

Sound bar



Telecomando



Batterie



Materiale illustrativo



Cavo di alimentazione sound bar

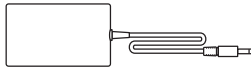

Alimentatore sound bar



Cavo HDMI da 6.5' (2 m)



Cavo ottico da 6' (1,8 m)

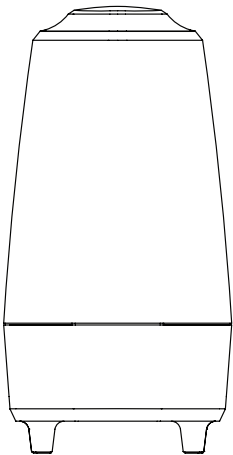

Subwoofer



Cavo di alimentazione Subwoofer

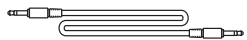

Cavo AUX da 6' (1,8 m)

Connettere il tuo MagniFi Mini alla tua TV

1a. C'è un jack di ingresso HDMI indicato come "ARC" sulla tua TV?

SÌ

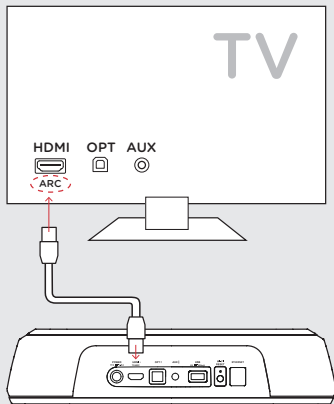

Usa il cavo **HDMI** in dotazione per connettere la sound bar alla TV.

NO

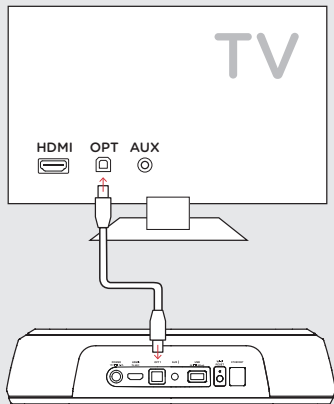

Usa il cavo ottico in dotazione per connettere la sound bar alla TV.

***DEVI avere un ingresso HDMI ARC sulla tua TV per usare l'HDMI.**

1b. Non hai ingressi HDMI o ottici disponibili sulla tua TV?

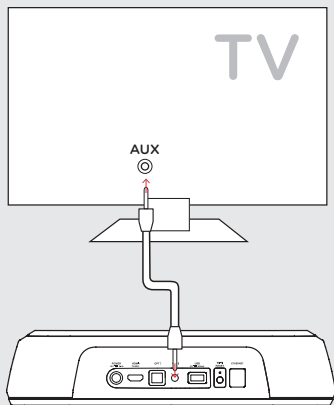

Se la tua TV non ha un uscita ottica o HDMI ARC, collega la sound bar alla TV con il cavo **AUX in dotazione**.

(La decodifica Dolby 5.1 è supportata solo su ingressi ottici o HDMI)

2. Installazione batterie

Inserisci le batterie AAA in dotazione.

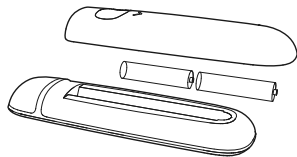

3. Connetti il cavo di alimentazione della sound bar ad una presa AC

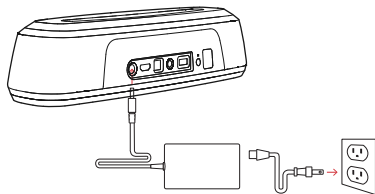

Un LED rosso lampeggerà sulla sound bar indicando l'accensione.

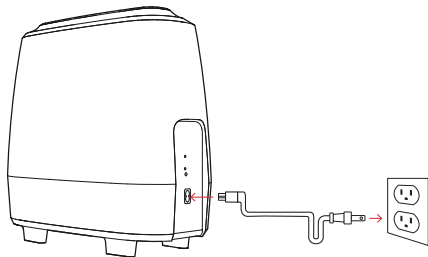
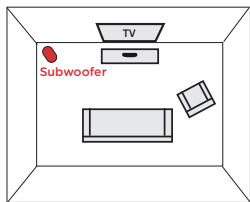

4. Posiziona il subwoofer e connettilo ad una presa AC
(Per migliori prestazioni posizionalo sullo stesso muro su cui c'è la TV)



NOTA: la sound bar ed il subwoofer wireless MagniFi Mini sono impostate dalla fabbrica per lavorare insieme. Nel caso in cui il subwoofer wireless dovesse smettere di ricevere il segnale audio, segui queste istruzioni per ristabilire la connessione:

1. Accendi la tua sound bar. Premi contemporaneamente il pulsante *Bluetooth*  e il pulsante *source*  per 3 secondi.
2. Tieni premuto il pulsante SYNC sul retro del subwoofer per 3 secondi.
3. Il LED verde sul retro del subwoofer comincerà a lampeggiare più velocemente, per indicare che la sound bar ed il subwoofer si stanno connettendo, a connessione avvenuta il LED verde resterà acceso.

5. Accendi la tua sound bar
Premi il pulsante di accensione  sulla sound bar o sul telecomando.
Nota: assicurati che gli altoparlanti interni della TV siano spenti quando usi gli ingressi ottici o AUX.

Telecomando

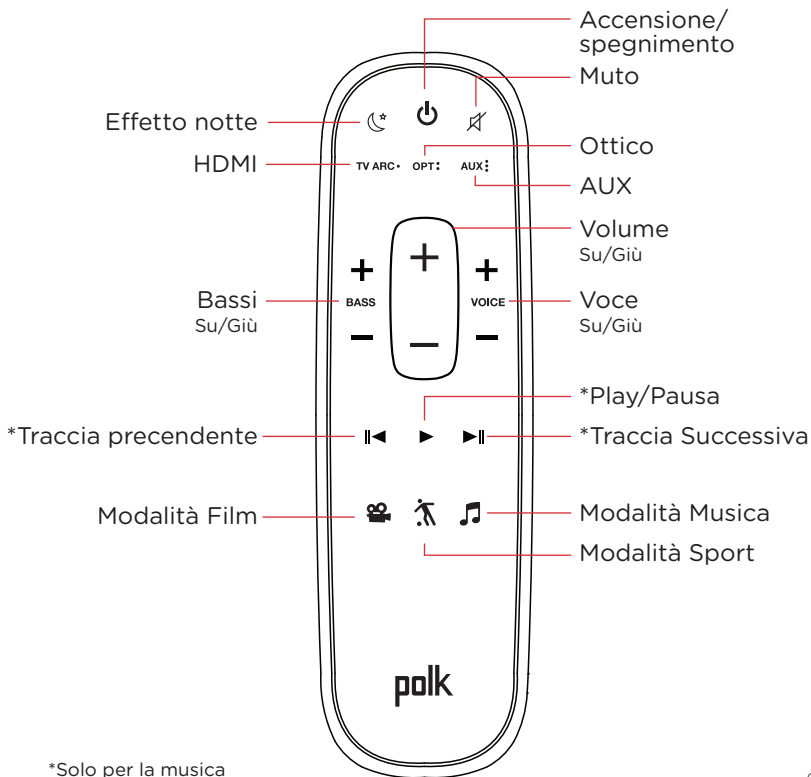

*Solo per la musica

Pannello superiore sound bar

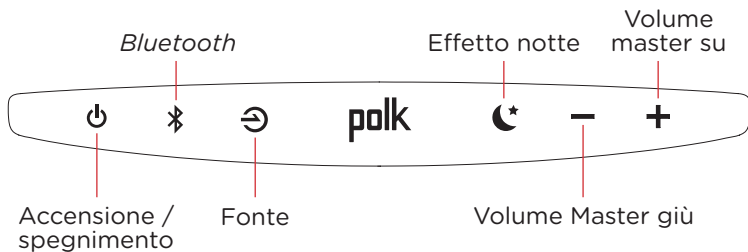

Pannello posteriore sound bar

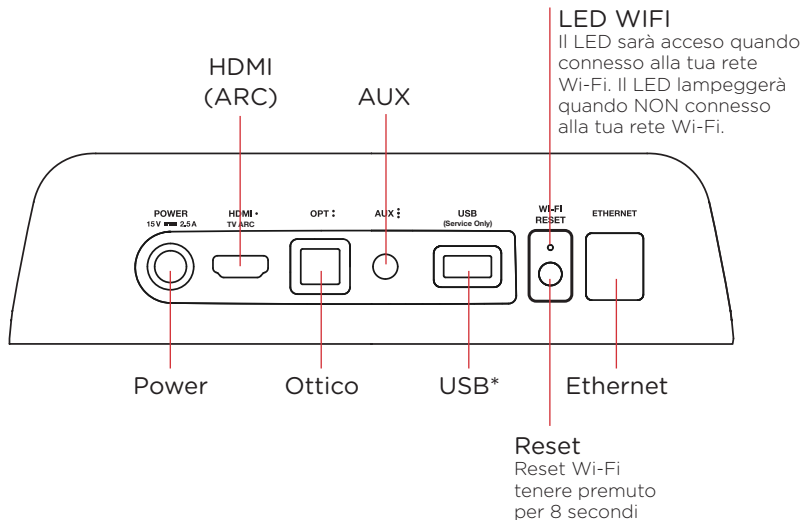

*Solo per uso di fabbrica

LED sound bar

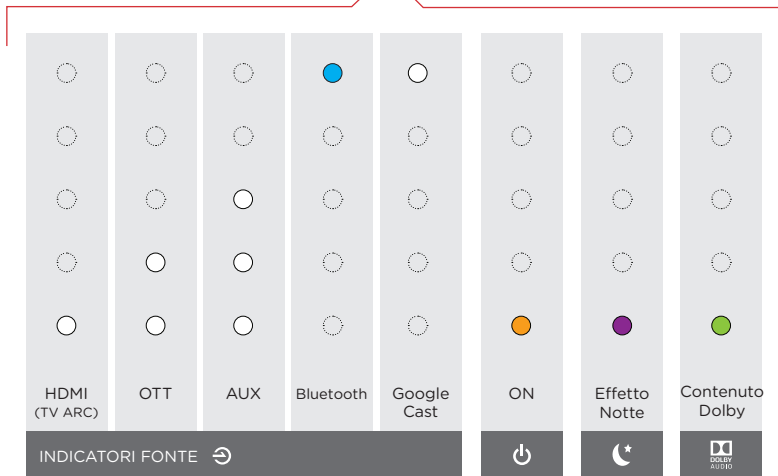
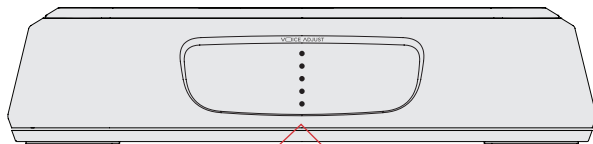

MagniFi Mini ha una linea verticale di luci LED che indicano lo stato, come la fonte, il volume e modalità d'ascolto.



Usare il telecomando TV o via cavo per controllare il MagniFi Mini

Il MagniFi Mini funziona in maniera ottimale con il suo telecomando incluso, tuttavia, puoi anche programmarlo affinché funzioni con il tuo telecomando TV o via cavo, seguendo i passaggi sottoindicati:

IMPORTANTE: Tieni entrambi i telecomandi a una distanza di 30 cm, direttamente di fronte al MagniFi Mini, quando premi i rispettivi tasti. Attendi almeno 1 secondo da quando premi un tasto a quando premi l'altro. Assicurati che i telecomandi siano dotati di batterie nuove.

1. Entra nella modalità di apprendimento, premendo e tenendo premuto il tasto  Source nella barra del suono, fino a quando senti un suono e la luce nella parte anteriore della barra del suono lampeggia su e giù.
2. Premi e rilascia il tasto del telecomando MagniFi Mini che vuoi associare (es: volume up).
3. Premi e rilascia il tasto corrispondente sul TUO telecomando, ripetutamente, fino a quando viene prodotto un suono di due note in sequenza ascendente. **NOTA:** attendi almeno 1 secondo da quando premi un tasto a quando premi l'altro!
4. Ripeti i passaggi 2 e 3 per far imparare i tasti Volume down, Mute, e Power al tuo telecomando.
5. Esci dalla modalità di apprendimento premendo e tenendo premuto il tasto  Source nella barra del suono, fino a quando senti un suono e le luci nella parte anteriore della barra del suono smettono di lampeggiare.
6. Verifica che il tuo telecomando riesca a controllare i tasti che hai programmato (es: Volume up) sul MagniFi Mini.

NOTA:

- Sentirai un suono diverso (discendente), se il comando non viene imparato. In tal caso, riprova.
- MagniFi Mini uscirà dalla modalità di apprendimento dopo 1 minuto di inattività, salvando eventuali codici imparati.

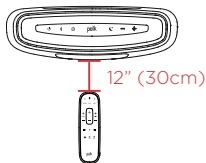

Ottimizza la tua esperienza d'ascolto

Controllo Bassi

Controlla i livelli di volume dei bassi

Regola il volume dei bassi per un impatto maggiore o minore.

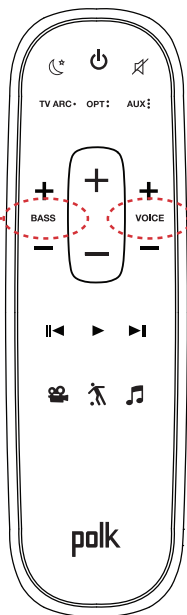
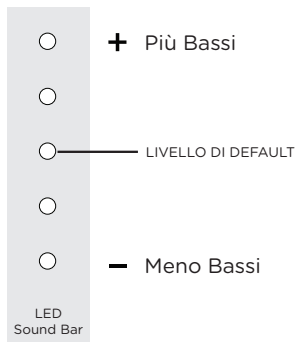

VOICE ADJUST™

Controlla i livelli di volume dei dialoghi

Isola e regola i livelli dei canali vocali per riprodurre dialoghi limpidi e cristallini.

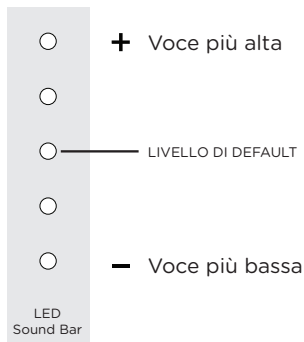



Modalità Film

Migliora la riproduzione audio per TV e film.



Modaltà Musica

Migliora l'audio quando ascolti la musica, o guardando la TV o dei film in cui ci sia musica.



Modalità sport

Migliora l'audio quando guardi sport, telegiornali e talk show.



Effetto notte

Riduce le dinamiche di bassi e volume mentre aumenta la comprensibilità della voce per ascolti a basso volume.

Servizi musicali

Come impostare Google Cast™

1. Accendi la sound bar.
2. Dal tuo telefono, tablet o computer visita:
chromecast.com/setup
3. Scarica la app Cast, fai clic sul tasto dispositivi nella app e seleziona MagniFi Mini. Segui le istruzioni di setup nella app.



4. Quando fai lo straming da Google Cast, una LED bianco comparirà sulla sound bar.

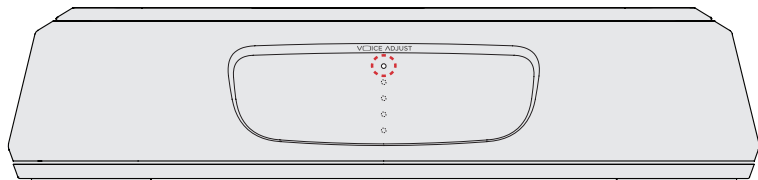

Come sentire la tua TV in seguito: Quando avrai finito di usare Google Cast, premi il pulsante fonte sulla sound bar o sul telecomando (TV ARC, OPT, AUX).

Come impostare il *Bluetooth*[®]

1. Per attivare il *Bluetooth*, premi il pulsante *Bluetooth*  sulla sound bar. Un LED blu lampeggerà lentamente sulla sound bar.

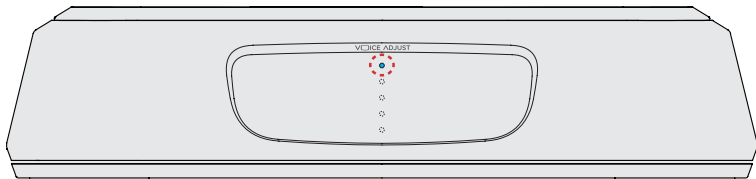

2. Vai alla sezione dispositivi *Bluetooth* sul tuo telefono, tablet o computer e seleziona Polk MagniFi Mini. Il LED diventerà blu fisso quando connesso al *Bluetooth*.

Nota: per prendere il controllo quando è connesso un altro dispositivo, premi il pulsante *Bluetooth*.

Come sentire la tua TV in seguito: Quando avrai finito di usare il *Bluetooth*, premi il pulsante fonte sulla sound bar o sul telecomando (TV ARC, OPT, AUX).



1 Viper Way
Vista, CA 92081
800-3777655
www.polkaudio.com

HBP3656E