

USER MANUAL

_JUNO CHORUS

ARTURIA

_The sound explorers

Special Thanks

DIRECTION

Frédéric Brun Kevin Molcard

DEVELOPMENT

Samuel Limier	Raynald Dantigny	Corentin Comte	Pierre-Lin Laneyrie
Kevin Arcas	Alexandre Adam	Loris De Marco	Mathieu Nocenti
Baptiste Aubry	Timotheé Behety	Geoffrey Gormond	Marie Pauli
Alessandro De Cecco	Yann Burrer	Rasmus Kürstein	

DESIGN

Martin Dutasta Clément Bastiat Shaun Elwood Morgan Perrier

SOUND DESIGN

Jean-Michel Blanchet

TESTING

Maxime Audfray Thomas Barbier

BETA TESTING

Charles Capsis IV	Pagnier	Paolo Negri	Georges Ware
Marco "Koshdukai" Correla	Neil Hester	Fernando Manuel Rodrigues	Chuck Zwicky
Dwight Davies	Mat Jones	Tony Flying Squirrel	
Andrew Henderson	Terry Marsden	Bernd Waldstäd	
Guillaume Hernandez-	Gary Morgan		

MANUAL

Fernando MANUEL RODRIGUES (author)	Camille Dalemans Vincent Le Hen	Holger Steinbrink Charlotte Métais	Minoru Koike José Rendon
---------------------------------------	------------------------------------	---------------------------------------	-----------------------------

© ARTURIA SA - 2020 - All rights reserved.
26 avenue Jean Kuntzmann
38330 Montbonnot-Saint-Martin
FRANCE
www.arturia.com

Information contained in this manual is subject to change without notice and does not represent a commitment on the part of Arturia. The software described in this manual is provided under the terms of a license agreement or non-disclosure agreement. The software license agreement specifies the terms and conditions for its lawful use. No part of this manual may be reproduced or transmitted in any form or by any purpose other than purchaser's personal use, without the express written permission of ARTURIA S.A. All other products, logos or company names quoted in this manual are trademarks or registered trademarks of their respective owners.

Product version: 1.0

Revision date: 18 December 2020

Thank you for purchasing Arturia's Chorus Jun-6...!

This manual covers the features and operation of the Chorus Jun-6.

Be sure to register your software as soon as possible! When you purchased Chorus Jun-6 you were sent a serial number and an unlock code by e-mail. These are required during the online registration process.

Special Messages

Specifications Subject to Change:

The information contained in this manual is believed to be correct at the time of printing. However, Arturia reserves the right to change or modify any of the specifications or features without notice or obligation.

IMPORTANT:

The software, when used in combination with an amplifier, headphones or speakers, may be able to produce sound levels that could cause permanent hearing loss. DO NOT operate for long periods of time at a high level or at a level that is uncomfortable.

If you experience any hearing loss or ringing in the ears, you should consult an audiologist.

Introduction

Congratulations on your purchase of Arturia's Chorus Jun-6...!

Arturia's passion for synthesizers and sonic purity has given demanding musicians the best software instruments for professional audio production.

Arturia also has a growing expertise in the audio field, and in 2017 launched the [AudioFuse](#), a pro studio quality audio interface that features two proprietary DiscretePRO® microphone preamplifiers and a set of top-notch AD/DA converters. This line was recently expanded with the launch of the [AudioFuse Studio](#) and the [AudioFuse 8Pre](#). Arturia has also been busy making effect plug-ins, launching in 2018 the first Arturia effects bundle, which included the [Pre 1973](#), the [Pre TridA](#), and the [Pre V76](#).

Other bundles followed, dedicated to compressors, filters, delays, and reverbs. More recently, Arturia added [three new effects](#) to the collection, this time dedicated to modulation, this way consolidating its position as a leader in audio effect plug-ins. Among these was a BBD-based chorus unit, the [Chorus DIMENSION-D](#).

The ARTURIA Chorus Jun-6 is another BBD-based modulation plug-in, this time emulating the built-in chorus unit of a famous synthesizer launched at the beginning of the 80s, which we also emulated with our Jun-6 V.

ARTURIA has a passion for excellence and accuracy. This has led us to conduct an extensive analysis of every aspect of one of the most famous and iconic synthesizers of the eighties. It was also a synth which definitely marked that era and has lately achieved "vintage" status, with prices rising in the second-hand market. We have carefully studied and reproduced the behavior of its electrical circuits and modules.

The synth's built-in chorus unit is a remarkable processor which greatly contributed to its big sound and success. That's why we had the idea to launch it as a separate effect plug-in.

Chorus Jun-6 runs as a plug-in in all major formats inside your DAW.

DISCLAIMER: All manufacturer and product names mentioned in this manual are trademarks of their respective owners, which are in no way associated or affiliated with Arturia. The trademarks of other manufacturers mentioned are used solely to identify the products of those manufacturers whose features and sound were studied during the development of this plug-in. All names of equipment inventors and manufacturers have been included for illustrative and educational purposes only and do not suggest any affiliation or endorsement of Chorus Jun-6 by any equipment inventor or manufacturer.

The Arturia team

Table Of Contents

1. WELCOME	2
1.1. What is a modulation effect?	2
1.2. What about Chorus Jun-6?	2
1.3. Where can you use a chorus unit like this?	3
2. ACTIVATION AND FIRST START	5
2.1. Activate the Arturia Chorus Jun-6 license	5
2.1.1. The Arturia Software Center (ASC)	5
2.2. Working with plug-ins	5
3. CHORUS JUN-6 OVERVIEW	6
3.1. Arturia's Chorus Jun-6 plug-in	6
3.2. Understanding the Chorus Jun-6 Signal Flow	7
3.3. Getting hands-on with Chorus Jun-6	8
3.3.1. Chorus Basics	8
3.3.2. Chorus Manual Mode	9
3.3.3. Chorus Mono-to-Stereo	10
4. CHORUS JUN-6 CONTROL PANEL	12
4.1. Channel Configuration (Mono/Stereo/Mono-to-Stereo)	12
4.2. Main Control Panel	13
4.2.1. Power	13
4.2.2. Mono In	14
4.2.3. Mode I	14
4.2.4. Mode II	14
4.2.5. Mode I + II	14
4.2.6. Manual mode	15
4.2.7. Mix	16
5. USER INTERFACE	17
5.1. The Upper Toolbar	17
5.1.1. Save Preset	17
5.1.2. Save Preset As	18
5.1.3. Import	18
5.1.4. Export Menu	18
5.1.5. New Preset	18
5.1.6. Resize Window options	19
5.1.7. Help	19
5.1.8. Preset Selection	19
5.2. The Lower Toolbar	20
5.2.1. Panic	20
5.2.2. Undo	20
5.2.3. History	20
5.2.4. Redo	20
5.2.5. Bypass	21
5.2.6. CPU meter	21
5.3. The Preset browser	22
5.4. Fine-tuning parameters	23
5.5. Resetting your controls	23
6. Software License Agreement	24

1. WELCOME

1.1. What is a modulation effect?

Modulation effects work by modifying the sound by means of modulation controlled by a Low-Frequency Oscillator (LFO). For example, they can add one or more slightly delayed versions of the sound to itself, while modulating the pitch of those versions over time.

You can obtain three main effect types with modulation: chorus, flanging, and phase-shifting. Of these three, chorus is perhaps the most sought-after, since it allows to create "richer" versions of the sound. The chorus effect works by mixing the audio signal with one or more delayed, pitch-modulated copies of itself. The pitch of the added voices is modulated by an LFO, which makes the overall effect similar to that of the flanger, except with longer delays and less modulation.

This effect may be used to recreate the one that naturally occurs when individual sounds, with approximately the same time and very similar pitches, converge and are perceived as one, as happens when you listen to a voice choir or a string ensemble (also sometimes designated as a "string choir") - hence the "chorus" name, and also the presence of "ensemble" presets in many chorus effects, and even some special tailored chorus effects called "ensemble" or even "symphony". You can say that the "chorus" effect sounds like multiplying the sound while widening and thickening it. It also allows to create a stereo image out of a mono signal.

Modulation effects can create a huge range of sonorities, and the results may be perceived as a fuller, richer sound. No wonder they have been used extensively since they appeared. Also, they have been an essential addition to almost any synthesizer since the eighties.



1.2. What about Chorus Jun-6?

The Arturia Chorus Jun-6 is an effect plug-in version of the famous chorus unit that was part of the Juno synthesizers, a version of which was also included in the recently launched Arturia Jun-6 V.

This unit is a BBD stereo chorus that greatly contributed to the enormous success of the Juno series of synthesizers, at the beginning of the 80s. Loved for its spatial enhancement and fatness, this chorus unit is so important for the overall synth sound that doing away with it was unimaginable.

It is also remarkable for its simplicity. In fact there are only two buttons to operate the original. The chorus is preset-based, and each button selects one preset configuration. By pressing the two buttons simultaneously, you get a third configuration.

The distinctive sound of this device is mostly due to its BBD (bucket-brigade delay) chip architecture, and the original output signal cross mix. This results in a unique warm analog sound and character, which is able to create a huge sound out of a single mono source.

The bucket-brigade architecture owes its name to the analogy with a line of people passing buckets of water from hand to hand. That's exactly what happens in an analog chip architecture like this, where the signal passes from capacitor to capacitor with delays added, one step per clock cycle.

1.3. Where can you use a chorus unit like this?

A chorus has a multitude of uses. As was mentioned already, it works great to add dimension to a mono sound, transforming it to stereo (when used in a mono-to-stereo configuration). Also, it may contribute an extra degree of density to any sound, transforming a solo into a choir or ensemble (exactly what's implied in the effect's name).

Those that know the Juno-6 or the Juno-6O immediately understand how important the chorus is. In fact, never before had a single oscillator synthesizer sounded so rich and full.

That said, it's the sounds that naturally demand ensemble and dimension effects that can benefit most from a chorus effect. Sounds like strings, brass and winds can come up bigger with chorus. A solo instrument like guitar or voice, for example, can also benefit from the addition of a chorus effect.



Vocals, naturally, can greatly profit from a chorus unit, especially background vocals. But lead vocals too can benefit from the extra dimension added by a good chorus unit.

We've already mentioned the ensemble sounds, but keyboards in general can grow a lot with the addition of chorus. Organs (of course - of any kind), but also pianos, especially the electric piano (possibly complemented with other modulation effects...).

But you can use chorus pretty much anywhere, and in many ways.

2. ACTIVATION AND FIRST START

The Arturia Chorus Jun-6 plug-in works on computers equipped with:

Windows 8 or later and macOS 10.13 or later.

You can use the Chorus Jun-6 plug-in as an Audio Unit, AAX, VST2 or VST3 plug-in (64-bit only).



2.1. Activate the Arturia Chorus Jun-6 license

Once the software has been installed, the next step should be to activate your license, so that you can use it without limitations.

This is a simple process which involves a different software program: the Arturia Software Center.

2.1.1. The Arturia Software Center (ASC)

If you have not already installed the ASC, go to this web page:

<https://www.arturia.com/support/updates&manuals>

Look for the Arturia Software Center at the top of the page, and then download the version of the installer that you need for your system (macOS or Windows).

Follow the installation instructions and then:

- Launch the Arturia Software Center (ASC)
- Log into your Arturia account
- Scroll down to the My Products section of the ASC
- Click the Activate button

That's all there is to it!

2.2. Working with plug-ins

Chorus Jun-6 can be used in all major digital audio workstations (DAWs), including Live, Logic, Cubase, Pro Tools and others, as it comes in all the main plug-in formats. Unlike what happens with hardware, you can load as many instances of the effect as you find useful. Chorus Jun-6 has two other big advantages over hardware:

- You can automate numerous parameters using your DAW's automation system;
- Your settings and current plug-in state will become recorded in your project, and you can pick up exactly where you left off the next time you open it.

3. CHORUS JUN-6 OVERVIEW

3.1. Arturia's Chorus Jun-6 plug-in

Our goal was to give users the experience of a great tool from the past. But although we have worked to be faithful to the unit sound, basic appearance and workflow, it wouldn't be an Arturia plug-in without the addition of some extra features to enrich your user experience. In this case, we added a few sliders to offer you some control over the effect.



We kept the user interface's simplicity. The Main panel has the original controls, which are just a couple of buttons. We kept the original I and II buttons which were present in the synth, and also the possibility to press both buttons simultaneously, to achieve a third effect configuration. The panel also includes a "MANUAL" button which activates the manual control faders.

We will take a detailed look at all of these things in the [Control Panel chapter \[p.12\]](#). Now, it's time to check out how it works and how it sounds. Let's go!

3.2. Understanding the Chorus Jun-6 Signal Flow

The Chorus Jun-6 is an effect plug-in with a very simple control panel interface, offering just a few controls. Nevertheless, its simplicity hides a very effective chorus engine.

Chorus JUN-6

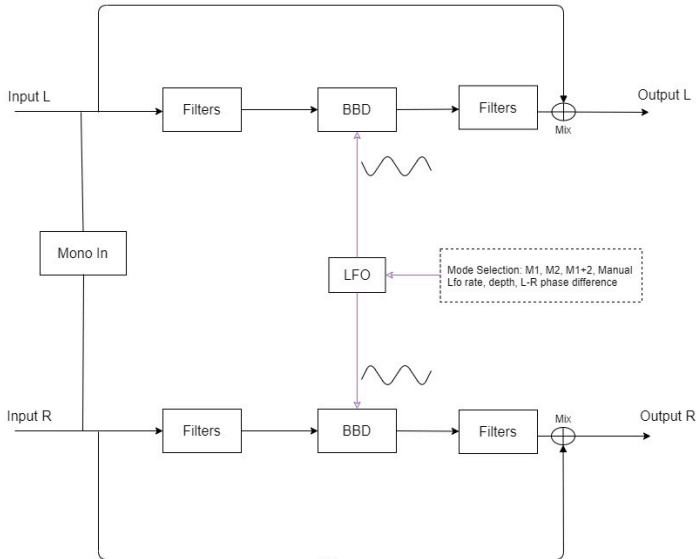

The Chorus can accept Stereo or Mono input signals. It can also "monoize" a stereo input signal, when you turn On the Mono In button (only for the stereo plug-in version). The original Juno Chorus takes a mono input and "stereoizes" it. This button provides a shortcut for this behavior when the input is stereo. When it is On, both input channels will be summed into mono, prior to the chorusing effect being applied.

The Mono or Stereo input will then be sent through the filter stage. If the signal is mono (or was "monoized") it will be split into two channels. If the signal is already stereo, each channel will follow its own path.

Both Left and Right channels have a dry path and a processed path. First stage of the processed signal is the input filters.

The signal then enters the BBD circuit. The clock of the BBD is modulated by an LFO. The LFO is phase-inverted from one channel to the other, creating the beloved stereo effect this chorus is best known for.

This section can be set to one of three preset configurations (buttons I, II, and I + II) or set to manual, in which case you can manually control the LFO rate, modulation depth, and phase difference between the two channels. This means that you have an extra degree of flexibility added.

After the BBD circuit, the signal is low-pass-filtered again, and then sent to the mixing stage, where it will be mixed with the dry signal. This stage includes another improvement added by Arturia. In fact, you can mix the dry and the wet (which was impossible in the original unit). We also included power compensation to maintain the same perceived level. In the hardware, when you activate the chorus, you increase the level. Here you keep a similar output level, with an equal power crossfade between dry and wet.

So when you are at full dry, you have the same level of dry and when you increase the wet signal, the level of dry decreases.

And that's it. This is the complete signal flow of Chorus Jun-6. Study the circuit, spend some time with the controls, and we're sure you'll fall in love with this chorus unit. The following section will definitely help you with this.

3.3. Getting hands-on with Chorus Jun-6

3.3.1. Chorus Basics

To get an idea of the Chorus Jun-6's capabilities, we suggest you try the following:

- Load a stereo clip into an audio track in your DAW (vocal tracks, a solo guitar track or some keyboard licks are ideal for this);
- Load an instance of Chorus Jun-6 as an insert in that track. Open the Chorus Jun-6 window;
- Ensure the Default preset is loaded. This means that all settings are positioned at their initial values;
- Begin playback. The clip will already show some processing. This is because button I is pressed;
- Press button II while the music is playing. You'll notice that the chorus sound changes.
- Now press the small button below I and II. Both buttons will turn On. This time, the sound changes more. This is because this preset has completely different settings. You may think of it more like a vibrato effect than a chorus effect.
- These are the three single chorus modes. Chorus Jun-6 is preset-based, although it has a manual mode too;

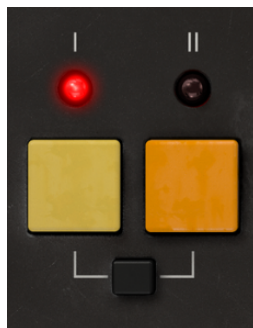

3.3.2. Chorus Manual Mode

- Press button I again. You are now back to preset Mode I. Now press the Manual button. Notice that the sound doesn't change. That's because the default manual settings exactly correspond to Mode I;
- Now try the three controls that affect the chorus in manual mode. Maybe it's a good idea to put the LFO in Sync. Press the small "eighth-note" button. Now use the Rate control to select a value that's fast enough to be noticeable, but slow enough not to become annoying. Usually, a value of 1/2 (one eighth-note) is a good value, if the tempo is not too fast (around 100/120 bpm);
- You may now try changing the Depth control, but usually the default value is good enough. Finally, let's see the Phase control. This fader controls the phase difference of the LFO between the two channels. The wider the difference, the wider the stereo effect. The default position is 180 degrees, which means the LFO is in opposite phase between channels. Again, this default position is usually the best one;

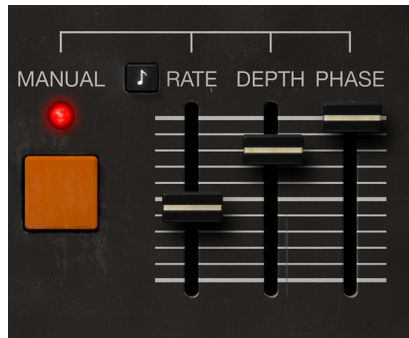

i ⚠: Be aware that the Phase control works differently when the plug-in is instantiated in Mono. You will still hear a result of the offset of the LFO phase, but it will not have any effect on the stereo field, because there isn't one.

3.3.3. Chorus Mono-to-Stereo

- When using the Chorus Jun-6 in a stereo track, you will have another control - a Mono/Stereo switch in the upper part. This control will "monoize" the input signal before applying chorus to it. This is because the original chorus unit is a mono-to-stereo unit on its own. It can create a stereo image even if the audio source is mono. Press it to check the difference;



- You may now try the Mix knob. This knob varies the amount of dry signal that is mixed with the processed signal. By default, it is set to 50/50. You may try different values, of course;
- You may also try to sum more than one instance. If you instantiate a second Chorus Jun-6, it will process the sound coming out of the first instance. You may even pile up three instances, each with its own settings, this way achieving a "super chorus". Don't worry, the plug-in is very light on the CPU, so you should not notice any significant increase in CPU power consumption;

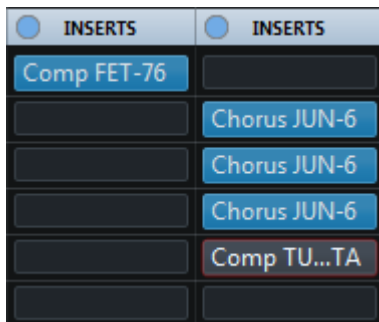

- You may now try the chorus with a mono source. Load a mono file in an audio track. If your DAW supports mono files, you'll notice that chorus's main panel no longer displays the mono-to-stereo switch. This is because you cannot have a stereo input from a mono channel. But you will still notice a result if you change the Phase, even though it doesn't reflect in a wider stereo field;

These are just some examples of what you can do with Chorus Jun-6. Despite looking deceptively simple, it offers more than you could imagine. As always, use your imagination, and try to find other creative and interesting ways of using it.

4. CHORUS JUN-6 CONTROL PANEL

The Chorus Jun-6 plug-in can be used in Mono, Stereo or Mono-to-Stereo configurations, independently of the source material.

The Mono configuration is automatically loaded when you use the plug-in with mono tracks. When inserted in stereo tracks, the Stereo configuration is automatically loaded as well. When instantiated in a stereo channel, the plug-in can be configured as a Mono-to-Stereo unit by turning On the Mono In switch, to achieve a different sound. In this mode, both channels are summed before being processed. The resulting stereo output is achieved by the plug-in's processing.

By default, the plug-in works in stereo, but you can "monoize" the source signal by turning On the "Mono In" switch.



ⓘ Not all DAWs are able to work with mono tracks, in which case you will not be able to use the mono configuration.

4.1. Channel Configuration (Mono/Stereo/Mono-to-Stereo)

The difference between Mono configuration and Stereo configuration consists in the following:

When instantiated in stereo channels, the plug-in loads in full mode, featuring the Mono In (Mono/Stereo) switch in the Main panel. It receives and processes mono or stereo signals. The Mono In switch "monoizes" a stereo signal.

When instantiated in mono channels, the plug-in doesn't have the Mono In switch, since there will only be mono signals.



Chorus Jun-6 in Mono configuration. Notice the absence of the Mono In switch.

4.2. Main Control Panel

The Chorus Jun-6 Graphical User Interface is very simple, and is inspired by the original chorus section of the synthesizer in which it was featured.

As is the case with the previous effects, as well as with all current Arturia plug-ins, this GUI has an Upper Toolbar and a Lower Toolbar. The Lower Toolbar is very important for the use of Arturia plug-ins, as it features the Undo and Redo functions, lists editing history, allows you to put the plug-in in Bypass (which doubles the Power button in the Main control panel), and measures CPU consumption.

The Upper Toolbar is where you access the main menus, perform important tasks such as loading and saving presets and banks of presets, and where you can select a preset and see the name of the one currently in use. The toolbars and their features are covered in detail in the [User Interface chapter \[p.17\]](#).

We will now have a look at all the controls available, explaining what they do, what their ranges are and how to interpret the numbers.

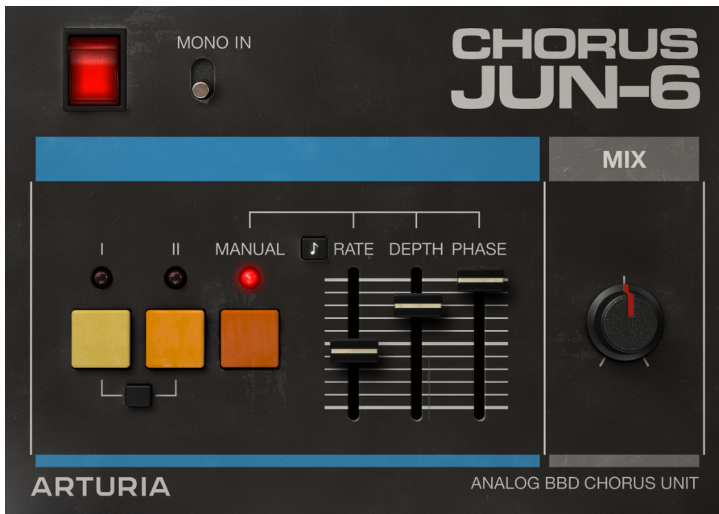

Notice that each time you click a control (knob or button), or simply hover the mouse over it, the Lower Toolbar displays the parameter name at the lower left. Also, a small pop-up box appears to the right of the control displaying the current parameter value. This changes every time you move that control, updating the parameter value in real time.

Now, let's take a look at each control on the Main Control Panel.

4.2.1. Power

This button turns On the plug-in. Turning it Off has the same effect as pressing the Bypass button in the Lower Toolbar - it puts the plug-in in bypass mode.



4.2.2. Mono In

This switch has two positions: Stereo and Mono In. When in Stereo, you have full stereo processing. When in Mono In, the source signal is "monoized" (Left and Right inputs are summed before processing). The output will still be stereo, though, as the plug-in will create a stereo signal out of the mono input (just like the original).



The Mono In switch is absent when the plug-in is instantiated in mono channels, since there is no stereo signal to start with.

By default, the switch is in the Stereo position.

4.2.3. Mode I

This is the first chorus preset configuration from the original synth, and the one it opens on by default. This configuration can be described as "mild chorus". LFO phase is inverted 180 degrees between channels to achieve a stereo effect.

4.2.4. Mode II

This is the second chorus preset. This configuration can be described as "deeper and richer chorus". This is mainly due to a slightly faster LFO rate. Delay times are the same as in preset I. Once again, LFO phase is inverted 180 degrees between channels to achieve a stereo effect.

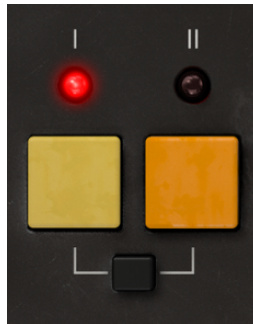

4.2.5. Mode I + II

This is the equivalent of having both I and II buttons pressed in the original. Contrary to what could be expected, this preset isn't equivalent to the sum of the other two. Actually, it is rather different. LFO rate is much faster, and delay times are shortened. Also, the LFO waveform in this mode changes from triangle to sine. This effect could be described as similar to a Leslie rotary speaker. In fact, it is more a vibrato effect than a chorus effect. Also, since the LFO phase is not inverted between the two channels, the chorus unit doesn't add spread to the stereo image.

Most likely, the original hardware synth designers estimated that it would be interesting to add a vibrato-like effect on the synth. Since we wanted to remain faithful to the original, we kept this effect here as well.

4.2.6. Manual mode

This is a treat introduced by Arturia. In fact, in this mode you can create your own chorus configurations. True, you only have three parameters to edit, but things don't always have to be complex to be compelling.

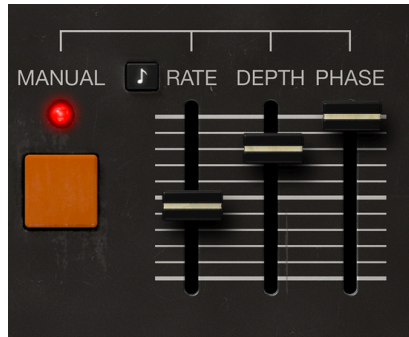

4.2.6.1. Rate

This is perhaps the most important parameter. It sets the LFO rate, which means precisely the frequency at which the LFO oscillates. As we've already seen, to achieve true chorus, you need to have quite slow rates. Faster rates will turn the chorus into something else, depending on your needs.

By default, the LFO rate is 0.400 Hz. Range goes from 0.050 Hz up to 15.0 Hz.

4.2.6.2. Sync

This button changes the rate from absolute to relative (in sync with the host tempo). Values are no longer displayed in Hz, but in musical divisions.

When in Sync, the default value is 2d (dotted half-note). Range goes from 8 (eight whole notes, or eight 4/4 bars) to 1/64 (a 64th note).

4.2.6.3. Depth

As implied in the name, Depth is the amount of modulation applied to the BBD delays by the LFO. It can be regarded as the intensity of the perceived chorus effect.

Range goes from 0.00 to 10.0 ms. Default is 4.44 ms.

We are pushing the BBD circuit to delay ranges higher than what was available in the original design, reaching the BBD limits for clean delay operation.

4.2.6.4. Phase

Another very important parameter. This is what achieves a stereo effect out of a mono signal. In the hardware unit, in modes I and II, the LFO is 180 degrees out of phase between Left and Right (phase-inverted). With this control, you can vary between 0 degrees (LFO will be in phase between channels) and up to 180 degrees like in the original.

By changing the phase in one of the channels, you create a shift in the stereo image at the output of the chorus. This is what creates a full stereo image out of a mono source.

i: In the Mono version of the plug-in, you still have two LFO paths, but they are merged into mono (in the Stereo version, even when the Mono In button is pressed, they are kept Left and Right). So, in that mode, when you turn up the Phase fader you still offset the phase (and you can hear the result), but it will no longer have an effect on the depth of the stereo field, because there isn't one.

Default is 180 (phase-inverted).

4.2.7. Mix

This is a Dry/Wet control. It has a crossfade between dry and wet, so when at full dry, you have the same level as when you are at full wet. When you increase the wet signal, the level of dry decreases, achieving equal power.

Default is 50/50 (equal mix of Dry/Wet).



5. USER INTERFACE

The Graphical User Interface of the Chorus Jun-6 follows the Arturia paradigm developed in the most recent effect plug-ins.

The GUI is built around a main control panel inspired by the looks of the original controls present on the synthesizer. That main control panel is complemented with an Upper Toolbar and a Lower Toolbar.

The Upper Toolbar contains the Preset Selection displaying the name of the current selected preset, preset selection filters and navigation arrows, and the very important Main Menu on the left (the "Arturia" icon near the instrument name). It also has a button to access the Preset Library.

The Lower Toolbar displays the parameter names and brief explanations in the left-hand part. It also includes the Panic button, a History button, Undo and Redo buttons, and a CPU consumption meter.

The parameter values appear in small floating window "cells" next to the parameter control. The values update in real-time when you move the controls.

 To know a parameter current's value, position the mouse over the corresponding control for about one second, and a small window will appear next to it, revealing the value.

It is a very simple User Interface. That will always be the main focus of every Arturia product: to unleash your creativity while remaining easy to use.

We've already looked at the control panels. Now it's time to look at the toolbars.

5.1. The Upper Toolbar

The plug-in GUI (Graphical User Interface) has the usual Arturia toolbar that runs across the top edge, with the Arturia logo / plug-in name on the left (the colored part), followed by the Library button and the Preset name, with arrows to navigate through the different presets stored in the library.



Let's now take a look at the Main Menu options. Since these options are also common to all current Arturia plug-ins, you may already be familiar with them:

5.1.1. Save Preset

This option will overwrite the active preset with any changes you have made, so if you want to keep the source preset too, use the Save As option instead. See the next section for information about this.

5.1.2. Save Preset As...

When you select this option, you are presented with a window where you can enter information about the preset. In addition to naming it, you can enter the Author name, and select a Type. You can even create your own Type by entering custom names in the Type field. This information can be read by the preset browser and is useful when searching for the preset later.



5.1.3. Import...

This command lets you import a preset file, which can be either a single preset or an entire bank of presets. Both types are stored in **.cj6x** format.

After selecting this option, the default path to these files will appear in the window, but you can navigate to whichever folder you are using to store presets.

5.1.4. Export Menu

You can export presets in two ways: as a single preset or as a bank.

- **Export Preset:** Exporting a single preset is handy when you want to share it with someone else. The default path to these files will appear in the "Save" window, but you can create a folder at another location if you like. The saved preset can be reloaded with the import preset menu option.
- **Export Bank:** This option can be used to export an entire bank of presets from the plug-in, which is useful for backing up or sharing presets.

5.1.5. New Preset

This option allows you to create a new preset based on the Default template.

5.1.6. Resize Window options

The Chorus Jun-6 window can be resized from 50% to 200% of its original size without any visual artifacts. On a smaller screen such as a laptop, you might want to reduce the interface size so it doesn't dominate the display. On a larger screen or a second monitor, you can increase the size to get a better view of the controls. The controls work the same at any zoom level, but they can be harder to see at the smaller magnification values, or when using high resolution monitors (like HD monitors or higher). The higher the resolution, the bigger the size you should use.

5.1.7. Help

The Help section in this menu allows direct access to the User Manual (the document you are reading), as well as to the FAQ (Frequently Asked Questions).

5.1.8. Preset Selection

The [Preset browser \[p.22\]](#) can be opened by clicking the library symbol on the toolbar. The filter, name field and left / right arrows in the toolbar all assist with preset selection.

Select a preset by clicking the preset name field in the Upper Toolbar. That action will open a list with all the presets available. The currently selected preset is marked with a ✓. Then simply place the mouse over the name of the preset you want to select (the preset name will be highlighted), and click it.

Alternatively, you may use the Preset Forward and Backward arrows (the arrows at the right of the preset name field) to navigate through all the presets.



5.2. The Lower Toolbar

When you hover the mouse over a parameter control, you will see a readout showing that parameter's name and a brief description in the left part of the lower toolbar.

Also, you will notice a small popup window next to the control, displaying the current value of the parameter. This will also show the value changes when you move the control (edit the parameter). This is handy, because you don't need to touch the parameter control to read the current value, and you can keep looking at the parameter while you read the value changes.



To the right of the lower toolbar are several small windows and buttons. These are very important features, so let's take a closer look.

5.2.1. Panic

When pressed, the Panic button turns off the audio to stop any stuck sound, this way preventing damage to your ears or speakers.

5.2.2. Undo

The Undo button is a curved arrow pointing to the left. This button reverts the last edit you performed. If it is clicked repeatedly it will revert the parameter changes in the order they were performed in the session, from the latest ones to the earliest ones.

5.2.3. History

This button lists all the parameter changes performed in the current session.

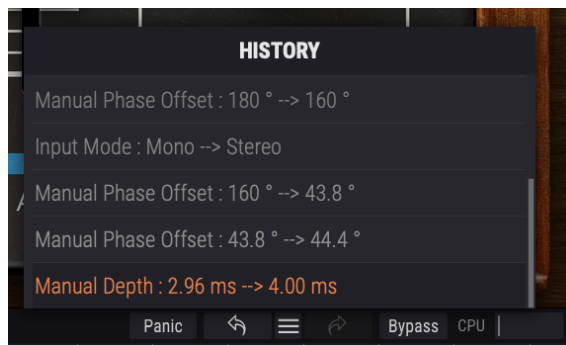

5.2.4. Redo

The Redo button is a curved arrow pointing to the right. This button works exactly the opposite way of the Undo button. It will reinstate the last undone edit. If it is clicked repeatedly it will reinstate the parameter changes in the order they were undone (the latest undone ones first).

5.2.5. Bypass

This one is obvious. Activating the bypass option will completely disable the Chorus Jun-6 plug-in. This action may also be performed by the Power switch. When the Chorus is bypassed, the GUI is dimmed and shows the word "Bypassed".



5.2.6. CPU meter

The CPU meter is used to monitor how much of your computer's CPU is being used by the plug-in. If you stress your computer too much, the global performance of your system and the audio may suffer.

5.3. The Preset browser

The preset browser enables you to search, load and manage preset configurations in Chorus Jun-6. Although this looks like and is based on the usual Arturia Preset Browser, it is simpler, and even easier to work with. You access the preset browser by clicking on the library symbol next to the Arturia logo/plugin name on the left.

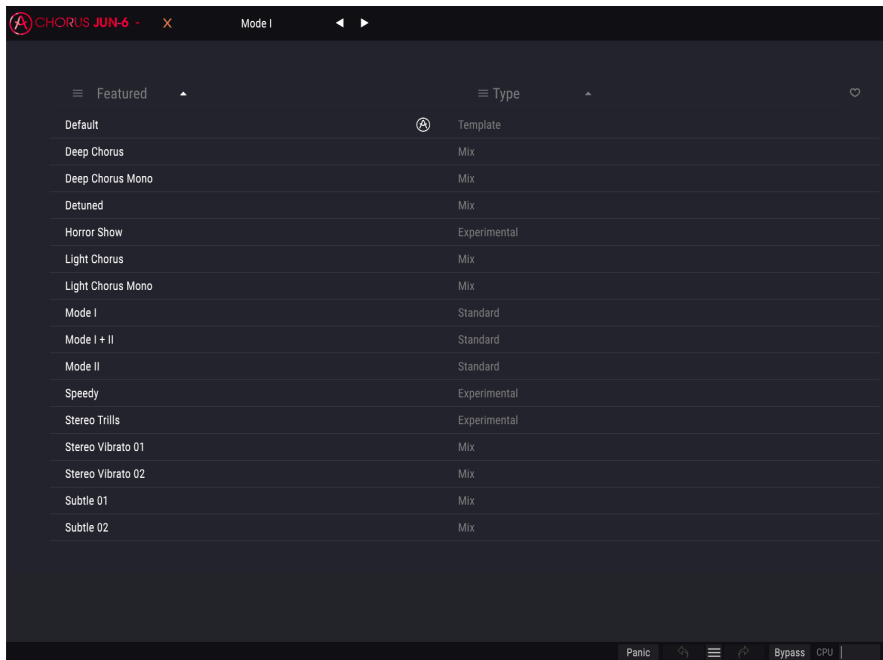

When you click on the library symbol, you will see a screen with all the Presets you have saved. You can sort the list by several different criteria to make it easier to find the right preset. There are two columns. The first one can list the Presets by Name or by "Featured". The Featured presets were selected as of particular interest by Arturia. The second one lists the Presets by Type or by Designer.

There is only one attribute visible, which is the one you select by clicking the column title. Type is the default attribute. When you select the Designer attribute the list changes and that attribute replaces the Type field in the second column.

If you want to delete a preset, first select it in the browser list. Next, click in the name field at the top to open the list of presets. Then choose the option "Delete current" at the bottom of the list, and confirm the action in the pop-up window.

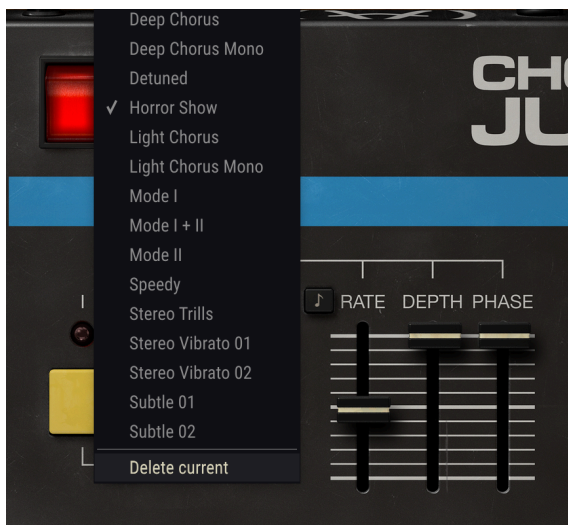

5.4. Fine-tuning parameters

Typically, to change values in the plug-in controls, just click on the corresponding control and drag the mouse up or down. If the controls are switches, simply click them to toggle On or Off.

If you want finer editing values, you can use Ctrl+Drag (Cmd+Drag for macOS). Alternatively, you can Right-Click and Drag. With this technique the values change more slowly, which enables you to edit them with greater precision.

5.5. Resetting your controls

Double-clicking a control automatically changes it to the default value.

And that's it. We have just finished describing all the controls you have at your disposal to process sound in your DAW using the Chorus Juno-6 plug-in. We hope you'll enjoy your new plug-in (and the results you get with it!) as much as we enjoyed making it.

6. SOFTWARE LICENSE AGREEMENT

In consideration of payment of the Licensee fee, which is a portion of the price you paid, Arturia, as Licensor, grants to you (hereinafter termed "Licensee") a nonexclusive right to use this copy of the SOFTWARE.

All intellectual property rights in the software belong to Arturia SA (hereinafter: "Arturia"). Arturia permits you only to copy, download, install and use the software in accordance with the terms and conditions of this Agreement.

The product contains product activation for protection against unlawful copying. The OEM software can be used only following registration.

Internet access is required for the activation process. The terms and conditions for use of the software by you, the end-user, appear below. By installing the software on your computer you agree to these terms and conditions. Please read the following text carefully in its entirety. If you do not approve these terms and conditions, you must not install this software. In this event give the product back to where you have purchased it (including all written material, the complete undamaged packing as well as the enclosed hardware) immediately but at the latest within 30 days in return for a refund of the purchase price.

1. Software Ownership Arturia shall retain full and complete title to the SOFTWARE recorded on the enclosed disks and all subsequent copies of the SOFTWARE, regardless of the media or form on or in which the original disks or copies may exist. The License is not a sale of the original SOFTWARE.

2. Grant of License Arturia grants you a non-exclusive license for the use of the software according to the terms and conditions of this Agreement. You may not lease, loan or sublicense the software. The use of the software within a network is illegal where there is the possibility of a contemporaneous multiple use of the program.

You are entitled to prepare a backup copy of the software which will not be used for purposes other than storage purposes.

You shall have no further right or interest to use the software other than the limited rights as specified in this Agreement. Arturia reserves all rights not expressly granted.

3. Activation of the Software Arturia may use a compulsory activation of the software and a compulsory registration of the OEM software for license control to protect the software against unlawful copying. If you do not accept the terms and conditions of this Agreement, the software will not work.

In such a case the product including the software may only be returned within 30 days following acquisition of the product. Upon return a claim according to § 11 shall not apply.

4. Support, Upgrades and Updates after Product Registration You can only receive support, upgrades and updates following the personal product registration. Support is provided only for the current version and for the previous version during one year after publication of the new version. Arturia can modify and partly or completely adjust the nature of the support (hotline, forum on the website etc.), upgrades and updates at any time.

The product registration is possible during the activation process or at any time later through the Internet. In such a process you are asked to agree to the storage and use of your personal data (name, address, contact, email-address, and license data) for the purposes specified above. Arturia may also forward these data to engaged third parties, in particular distributors, for support purposes and for the verification of the upgrade or update right.

5. No Unbundling The software usually contains a variety of different files which in its configuration ensure the complete functionality of the software. The software may be used as one product only. It is not required that you use or install all components of the software. You must not arrange components of the software in a new way and develop a modified version of the software or a new product as a result. The configuration of the software may not be modified for the purpose of distribution, assignment or resale.

6. Assignment of Rights You may assign all your rights to use the software to another person subject to the conditions that (a) you assign to this other person (i) this Agreement and (ii) the software or hardware provided with the software, packed or preinstalled thereon, including all copies, upgrades, updates, backup copies and previous versions, which granted a right to an update or upgrade on this software, (b) you do not retain upgrades, updates, backup copies and previous versions of this software and (c) the recipient accepts the terms and conditions of this Agreement as well as other regulations pursuant to which you acquired a valid software license.

A return of the product due to a failure to accept the terms and conditions of this Agreement, e.g. the product activation, shall not be possible following the assignment of rights.

7. Upgrades and Updates You must have a valid license for the previous or more inferior version of the software in order to be allowed to use an upgrade or update for the software. Upon transferring this previous or more inferior version of the software to third parties the right to use the upgrade or update of the software shall expire.

The acquisition of an upgrade or update does not in itself confer any right to use the software.

The right of support for the previous or inferior version of the software expires upon the installation of an upgrade or update.

8. Limited Warranty Arturia warrants that the disks on which the software is furnished is free from defects in materials and workmanship under normal use for a period of thirty (30) days from the date of purchase. Your receipt shall be evidence of the date of purchase. Any implied warranties on the software are limited to thirty (30) days from the date of purchase. Some states do not allow limitations on duration of an implied warranty, so the above limitation may not apply to you. All programs and accompanying materials are provided "as is" without warranty of any kind. The complete risk as to the quality and performance of the programs is with you. Should the program prove defective, you assume the entire cost of all necessary servicing, repair or correction.

9. Remedies Arturia's entire liability and your exclusive remedy shall be at Arturia's option either (a) return of the purchase price or (b) replacement of the disk that does not meet the Limited Warranty and which is returned to Arturia with a copy of your receipt. This limited Warranty is void if failure of the software has resulted from accident, abuse, modification, or misapplication. Any replacement software will be warranted for the remainder of the original warranty period or thirty (30) days, whichever is longer.

10. No other Warranties The above warranties are in lieu of all other warranties, expressed or implied, including but not limited to, the implied warranties of merchantability and fitness for a particular purpose. No oral or written information or advice given by Arturia, its dealers, distributors, agents or employees shall create a warranty or in any way increase the scope of this limited warranty.

11. No Liability for Consequential Damages Neither Arturia nor anyone else involved in the creation, production, or delivery of this product shall be liable for any direct, indirect, consequential, or incidental damages arising out of the use of, or inability to use this product (including without limitation, damages for loss of business profits, business interruption, loss of business information and the like) even if Arturia was previously advised of the possibility of such damages. Some states do not allow limitations on the length of an implied warranty or the exclusion or limitation of incidental or consequential damages, so the above limitation or exclusions may not apply to you. This warranty gives you specific legal rights, and you may also have other rights which vary from state to state.