

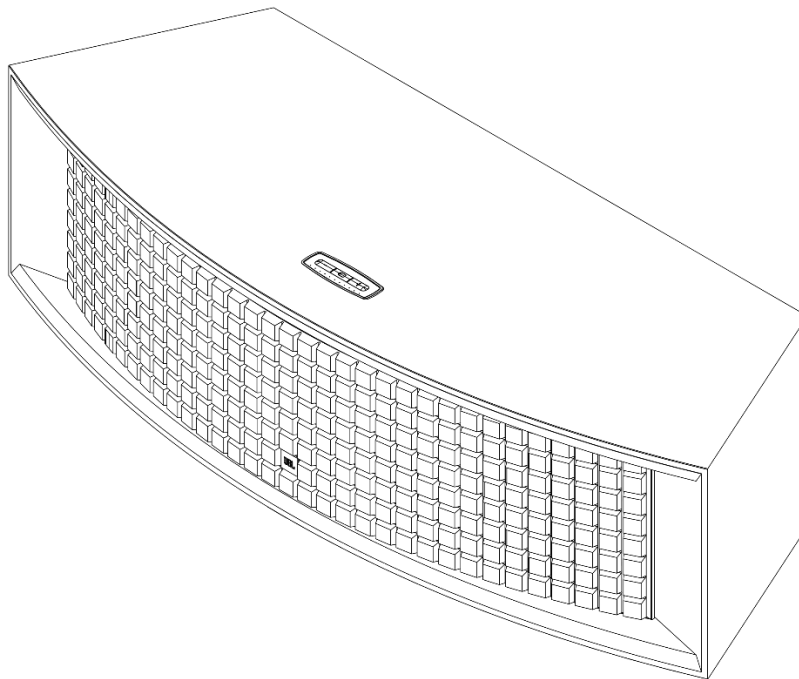

L75ms

Integrated Music System



Owners Manual

©2022 Harman International Industries, Incorporated
Features, Specifications, and Appearance subject to change without notice.



[JBL.com/Specialty-Audio/](https://www.jbl.com/Specialty-Audio/)

IMPORTANT SAFETY INSTRUCTIONS

1. Read these instructions.
2. Keep these instructions.
3. Heed all warnings.
4. Follow all instructions.
5. Clean only with a dry cloth.
6. Do not block any ventilation openings. Install this apparatus in accordance with the manufacturer's instructions.
7. Do not install this apparatus near any heat sources such as radiators, heat registers, stoves or other apparatus (including amplifiers) that produce heat.
8. Do not defeat the safety purpose of the polarized or grounding-type plug. A polarized plug has two blades with one wider than the other. A grounding-type plug has two blades and a third grounding prong. The wide blade or the third prong is provided for your safety. If the provided plug does not fit into your outlet, consult an electrician for replacement of the obsolete outlet.
9. Protect the power cord from being walked on or pinched, particularly at plugs, convenience receptacles and the point where they exit from the apparatus.
10. Use only attachments/accessories specified by the manufacturer.
11. Use only with the cart, stand, tripod, bracket, or table specified by the manufacturer or sold with the apparatus. When a cart is used, use caution when moving the cart/apparatus combination to avoid injury from tip-over.
12. Unplug this apparatus during lightning storms or when unused for long periods of time.
13. Refer all servicing to qualified service personnel. Servicing is required when the apparatus has been damaged in any way, such as when the power-supply cord or plug is damaged, liquid has been spilled or objects have fallen into the apparatus, or the apparatus has been exposed to rain or moisture, does not operate normally or has been dropped.





14. To disconnect this apparatus from the AC mains completely, disconnect the power-supply cord plug from the AC receptacle.
15. The mains plug of the power-supply cord shall remain readily operable.
16. This apparatus is intended to be used only with the power supply and/or charging cable provided by the manufacturer.

The following instructions may not apply to waterproof devices. Refer to your device user manual or quick start guide for more waterproof instruction if any.

- Do not use this apparatus near water.
- Do not expose this apparatus to dripping or splashing, and ensure that no objects filled with liquids, such as vases, are placed on the apparatus.

WARNING: TO REDUCE THE RISK OF FIRE OR ELECTRIC SHOCK, DO NOT EXPOSE THIS APPARATUS TO RAIN OR MOISTURE.

CAUTION	
RISK OF ELECTRIC SHOCK. DO NOT OPEN.	
	THIS SYMBOL ON THE PRODUCT MEANS THERE IS UNINSULATED, DANGEROUS VOLTAGE WITHIN THE PRODUCT ENCLOSURE THAT MAY PRESENT A RISK OF ELECTRICAL SHOCK.
	THIS SYMBOL ON THE PRODUCT MEANS THERE ARE IMPORTANT OPERATING AND MAINTENANCE INSTRUCTIONS IN THIS GUIDE.

Visit the product page at jbl.com/specialty-audio and download the Safety Sheet for a full list of safety instructions.

Table of Contents

IMPORTANT SAFETY INSTRUCTIONS	2
Product Overview	4
Basic Wiring Diagram.....	4
What's in the Box	4
Rear Panel Connections	5
Top Panel Controls	6
Remote Control Buttons.....	6
Initial Setup	7
Speaker Placement.....	7
Pairing the Remote	7
Connecting Sources.....	8
Connecting to Network.....	8
Connecting a Bluetooth Device	9
Using the L75ms	10
Wake from Standby.....	10
Selecting and Playing Sources.....	10
Controlling L75ms Volume	11
Sound Field Enhancement (SFX).....	11
Specifications	12
Wireless Specification	12
Product Specifications.....	12
Troubleshooting	13
Restoring Factory Defaults.....	13
Updating Firmware.....	13
Trademarks and Licenses	14

Product Overview

The L75ms supports a variety of sources from wireless streaming via Bluetooth and Wi-Fi to hard wired sources such as a phono turntable or TV. While some connections are specific, others can be any device that matches that match the connections type.

Basic Wiring Diagram

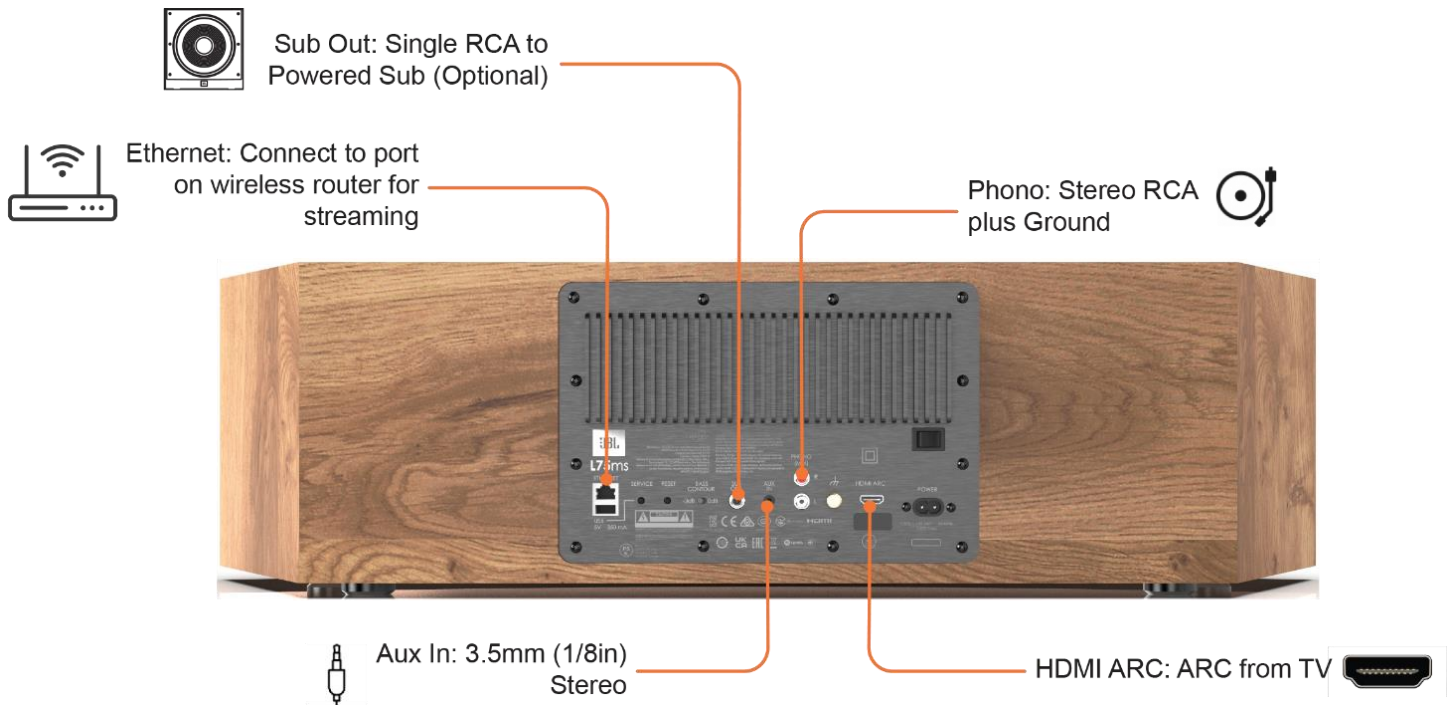

What's in the Box

- 1x L75ms Integrated Music System
- 1x Speaker Grille
- 1x RF Remote
- 1x Region Specific Power Cord

Rear Panel Connections

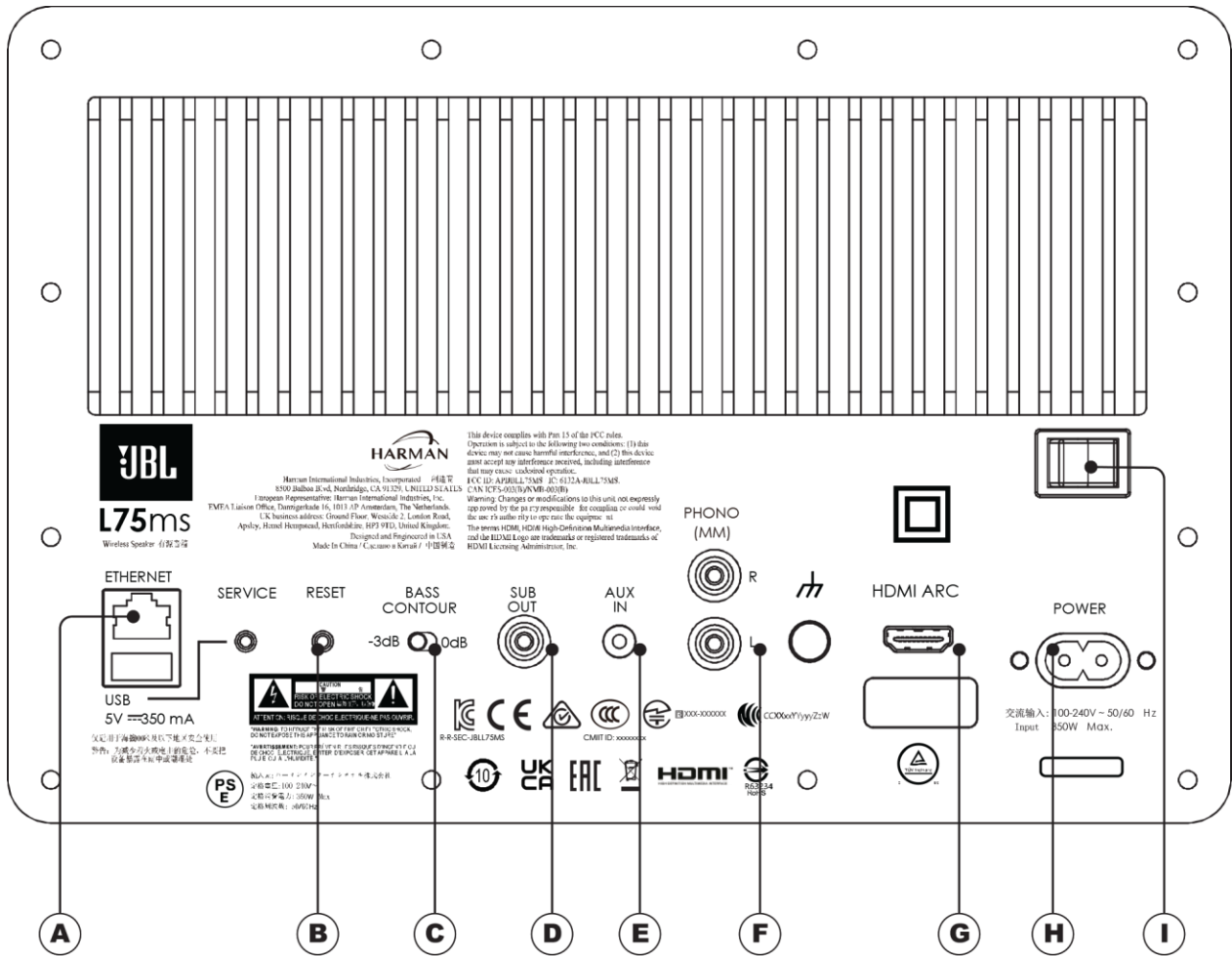

NOTE: Connections not noted here are for service use only and have no operation for regular use.

A Ethernet	RJ-45 10/100bit
B Reset	Resets L75ms to Factory Defaults. Refer to Restoring Factory Defaults for details.
C Bass Contour	Use to adjust for bas compensation based on nearness to boundaries. Refer to Speaker Placement for details.
D Sub Out	Single RCA - Connect to Powered Sub with LFE input
E Aux In	3.5mm (1/8") TRS Stereo Analog
F Phono In (MM)	RCA Stereo for Moving Magnet (MM) Phono Cartridge with Ground connection. Note: This input is configured for the gain required for a turntable and is not intended for analog line level outputs.
G HDMI ARC	Standard HDMI with ARC for use TV ARC Input. Only accepts 2ch PCM signals
H AC Power	Connect with supplied power cord.
I Main Power Switch	Ensure switch is on Off position while connecting or disconnecting sources.

Top Panel Controls

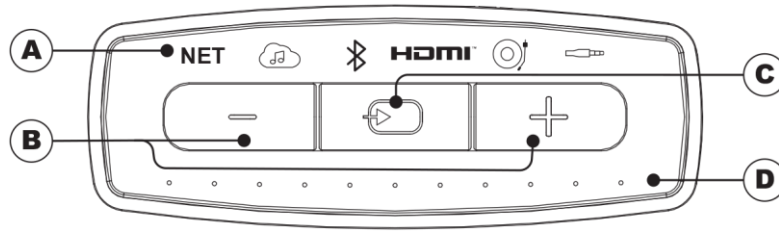

A Source Indicators	Indicates connection status. NET – White=Connected Blinking=Searching Red=Network Disabled Sources – White=Active Off=Not Active
B Volume Controls	Controls output volume of speaker
C Source Selection	Press to move to the next source.
D Volume Indicator	Dots illuminate from left to right as volume increases.

Remote Control Buttons

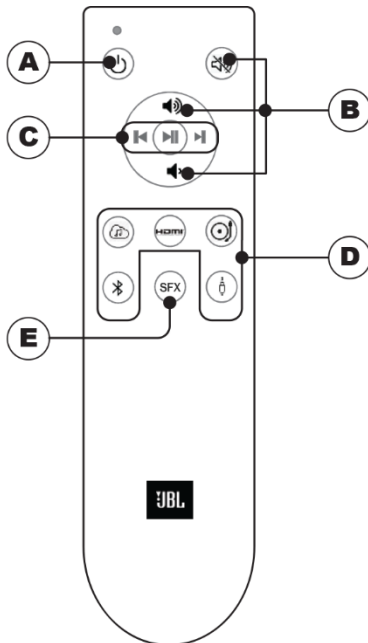

A Power	Toggles L75ms ON or OFF
B Volume Controls	Volume Up / Down and Mute
C Playback Controls	Previous / Next and Play / Pause
D Direct Source Selection	Network Streaming / HDMI-ARC / Phono / Bluetooth / 3.5mm TRS Stereo Analog
E SFX (Sound Field Enhancement)	Press to expand output to a more spacious sound field. Refer to Sound Field Enhancement (SFX) for more details.

Note: Pressing any button on the remote will wake the L75ms from Standby.

Initial Setup

Speaker Placement

Setting Boundary Compensation

The L75ms was designed to be placed on top of a cabinet or table in an open area away from boundaries such as walls or cabinet surfaces. The bass contour switch is used to compensate for placing the speaker on cabinet shelf where side and top areas are close to the speaker.

Set the Bass Contour switch located on the rear panel based on the speaker's proximity to side boundaries such as walls or the inside of a bookcase or cabinet. When close to a boundary the switch should be in the -3dB position in order to maintain level bass response.

Speaker on top of cabinet and away from walls.

Set Bass Contour to 0dB

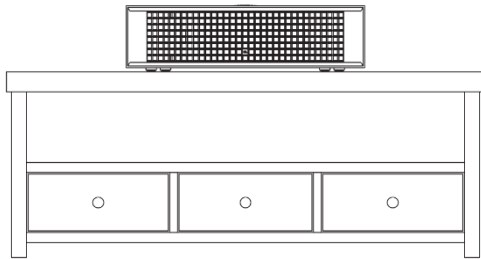

Speaker on cabinet shelf or close to walls.

Set bass contour to -3dB

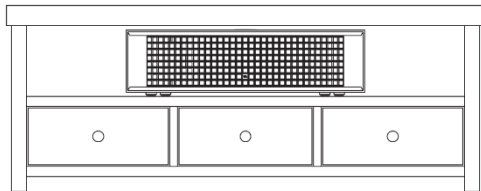

Pairing the Remote

Before the L75ms can be controlled via the included remote, the included remote must be paired to the L75ms.

1. Press & Hold the volume minus and source selection buttons on the top panel simultaneously for 2secs to initiate pairing mode.
2. Press & Hold the Network Stream and Play/Pause buttons on the remote simultaneously for 3secs.

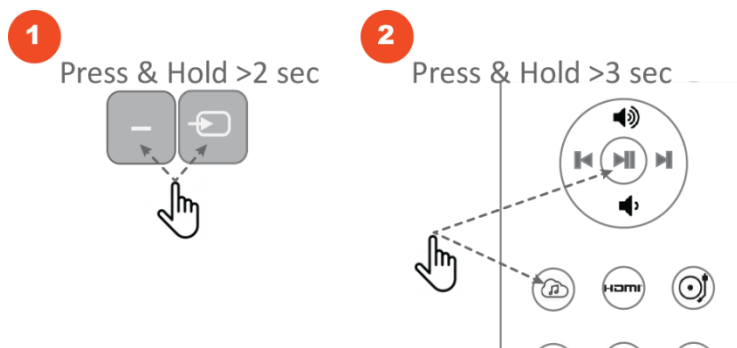

Connecting Sources

AUX – Connect using a 3.5mm (1/8”) TRS Stereo female for analog 2ch. Pinout follow standard configuration. Refer to [Rear Panel Connections](#) item E.

PHONO – Connect the stereo analog output of a turntable and the GND from the turntable to the GND on the L75ms. Note that this input is phono level can is not intended for analog line level outputs. Refer to [Rear Panel Connections](#) item F.

HDMI-ARC – Connect to the ARC input of a TV. Select the ARC input on the TV after making this connection and powering On the L75ms. Refer to [Rear Panel Connections](#) item G.

Note: The HDMI-ARC input on the L75ms does not decode multichannel or Dolby 2ch audio formats. In order for the L75ms to play content delivered to the HDMI/ARC the source device output must be set to 2ch PCM. Refer to the owners manual for your source device on details on how to select 2ch PCM output.

Connecting to Network

Wired Network Connection

Connect the Ethernet port on the rear to the port on a wireless router using a CAT-5e or higher cable. NET on the top panel will illuminate white once a network connection has been established. The L75ms is now available on the network for casting from media players such as Spotify or iTunes.

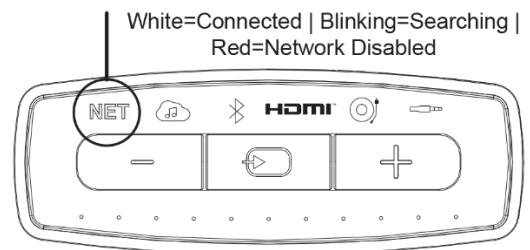

Note: If the NET icon is **RED** then network is disabled and must be enabled in order to connect. Refer to [Enabling and Disabling Network and Bluetooth](#) for details.

Wi-Fi Direct Connection

The Google home app is used to connect the L75ms to a Network for Android and Apple iOS devices. If you choose to not use Google Home and connect an Apple iOS device with Airplay, refer to [Wi-Fi Connection with Airplay](#).

Wi-Fi Connection with Google Home

1. On your mobile device, download and open the Google Home App.
2. Follow Google Home instructions to add devices.
3. Follow the prompts for adding devices. Note: We recommend giving the speaker a common name so that it can be easily found for streaming later.

NOTE: We recommend giving the L75ms a user-friendly name such as **Living Room Speaker**, if you choose to do so write it down as it will be what is used to connect to the unit for Wi-Fi or Bluetooth streaming.



Wi-Fi Connection with Airplay

1. Navigate to the network settings for your iOS device.
2. Select Wi-Fi and navigate to **Setup New Airplay Speaker**.
3. Select the device named **L75MS-XXXXXX**. The **XXXXXX** is the corresponding MAC address.
4. Select the network for the L75ms to use and select **Next**.
5. Follow the on-screen instructions to complete the setup of the L75ms as an Airplay speaker.

Enabling and Disabling Network and Bluetooth

Network and Bluetooth functionality may be turned Off should it be desired to do so. The same button operation can be used to turn Network and Bluetooth back On.

Press Source Selection & Volume + on the top panel simultaneously for >3 seconds.

Press Simultaneously

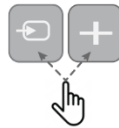

Note: When the Network and Bluetooth is Off the following conditions exist.

- Speaker cannot be used for Network or Bluetooth streaming.
- Handheld remote is in-operable and the unit can only be used via the top panel buttons.
- Network icon on top panel with show Red indicating that Network has been turned off.

Connecting a Bluetooth Device

Connection via Bluetooth is the same as other Bluetooth devices and varies from mobile device to mobile device. Refer to the owner's manual for the device being connected prior to performing the following steps.

1. Select the Bluetooth source via the button on the remote or via the top panel source selection.
2. Press & Hold the Bluetooth source or the source selection button for >3 seconds.
3. Navigate to your devices Bluetooth menu and select JBL L75MS from the list. Note if the name was changed during Google Home setup, that name will be listed.

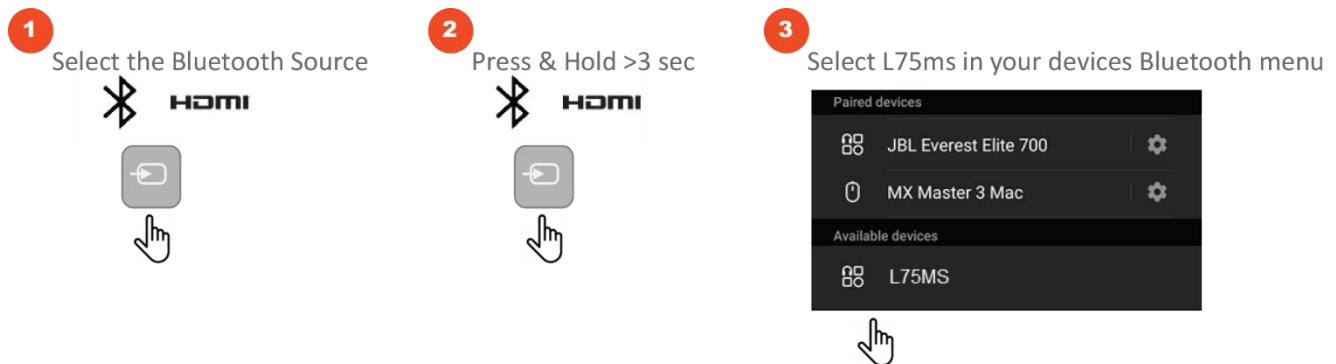

Using the L75ms

Wake from Standby

The L75ms enters standby mode when the power button is pressed or after 10mins of no signal on a selected source. To wake the L75ms from standby perform one of the following operations.

- Press any button on the remote or top panel.
- Connect to the L75ms via a Bluetooth or Wi-Fi Streaming Source.
- Power On device connected to L75ms via HDMI ARC

Selecting and Playing Sources

Sources may be selected directly by pressing the desired source button on the remote, using the source selection button on the top panel, or automatically for Network or Bluetooth streaming and HDMI ARC. Sources that can be automatically played will also wake the L75ms from Standby.

Using the Top Panel

Sources may be selected using the Source selection button located in the center of the top panel controls. Pressing it advance to the next source to the right. The source will illuminate **White** when it is active.

Sources can also be selected directly using the buttons on the included RF remote. Refer to [Remote Control](#) under [Product Overview](#) for details.

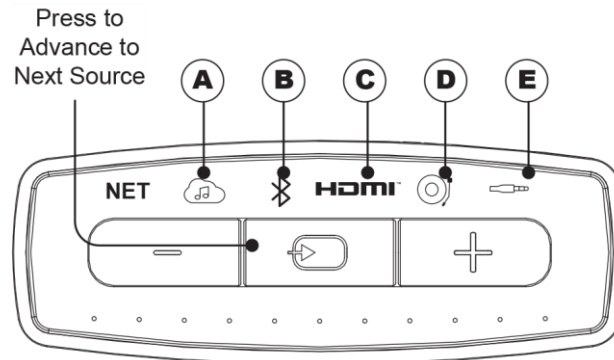

A	Streaming Sources	Auto Switch - Selected when a device initiates a stream.
B	Bluetooth	Auto Switch - Selected when a device connects via Bluetooth. Refer to Connecting a Bluetooth Device on details to connect a device.
C	HDMI-ARC	Auto Switch - Selected when a device connected to the HDMI input is powered on.
D	Phono	Analog stereo from turntable.
E	AUX	Analog stereo via 3.5mm (1/8") TRS Stereo Analog.

Automatically Selected Sources

Streaming sources and the HDMI-ARC input will automatically be selected when a source is chosen that is connected to the L75ms via cable in the case of HDMI-ARC or Wi-Fi and Bluetooth.

Network Streaming

The L75ms supports Google Chrome cast which allows the speaker to receive content through a network connection. Casting is done by selecting the cast symbol within the app being used or the connect function of the app. Refer to the apps usage information for details on using a specific apps functionality.

1. Open a source such as Spotify on a mobile device.
2. Select the desired content.
3. Press the Cast icon in the app and select the L75ms.

Note: Your phone or tablet may be used as a remote control. Visit spotify.com/connect to for details.

Apple Airplay

To listen to audio via AirPlay on the speaker, ensure your Apple device is connected to the same network as the Receiver and simply select the Speaker as the AirPlay audio playback device.

Bluetooth

1. Open the Bluetooth menu on your mobile device.
2. Select the L75ms from the list.
3. Open an app such as Spotify.
4. Select content and press play.

HDMI-ARC

The HDMI-ARC input will be automatically selected when the connected device is powered On regardless of standby state of the L75ms. It can also be selected by using the source select button on the top panel of the HDMI button on the remote.

1. Power On device connected to HDMI-ARC
2. L75ms will automatically select the HDMI-ARC input.

Controlling L75ms Volume

Volume for the L75ms can be controlled via the volume buttons on the top panel, the included remote, TV connected via HDMI ARC, and the volume buttons on device streaming via network or Bluetooth. Note that streaming device volume control depends on device and application being used.

Sound Field Enhancement (SFX)

The L75ms includes a Sound Field Enhancement mode accessible via the remote. This mode enhances the ambient sound of playing content for a more spacious effect that fills the room more than standard stereo. The difference between standard and enhanced sound varies based on several factors.

- Proximity to walls, floors, and ceilings. The closer the boundaries the more reflection there is.
- Ambience in the playing content. The more spacious and open the content the more obvious the effect will be.

Press the **SFX** button on the remote to activate Sound Field Enhancement.

Specifications

Wireless Specification

Bluetooth

- Remote Control Type: BTLE 2402-2480MHz@0.16dBm
- Bluetooth operation in 2402MHz to 2480MHz with max power 7.67dBm e.i.r.p
- Bluetooth LE operation in 2402MHz to 2480MHz with max power 9.59dBm e.i.r.p

Wi-Fi

- 802.11b/g/n operation in 2412MHz to 2472MHz with max power 16.96dBm e.i.r.p
- 5GHz RLAN 802.11a/n/ac: Operation in 5180MHz - 5240MHz; 5260MHz~5320MHz; 5500MHz - 5700MHz,
- with max power: 21.24dBm e.i.r.p
- 5.8G SRD operation in 5745MHz to 5825MHz with max power 12.94dBm e.i.r.p

Note: The device is restricted to indoor use when operated in the 5150-5350Mhz frequency range.

Product Specifications

Low Frequency	Dual 5.25" (133mm) Pure Pulp cone woofers
High Frequency	Dual 1" (25mm) Aluminum dome tweeters with waveguides
Mid Frequency	4" (100mm) Pure pulp cone midrange
Amplifier Power	125W RMS per woofer 25W RMS per tweeter 50W RMS for center (350W RMS total)
Frequency Response	45Hz-25kHz (-6dB)
Maximum SPL	106dB @ 1m
Sound Controls	Speaker placement boundary compensation Selectable Sound Field Expander (SFX)
Enclosure	Front-ported tabletop in satin walnut furniture-grade wood veneer
Grille	Black foam Quadrex grille
Wireless Inputs	WiFi streaming Bluetooth 4.2
Wired Inputs	HDMI ARC RJ-45 Ethernet Phono (MM) AUX: 3.5mm (1/8") TRS Stereo Analog
Resolution	Up to 32-bit, 192kHz
Subwoofer Output	2V RMS with auto-sense/engage HPF
Remote Control Type	BTLE
Dimensions with grille	8.5" H x 31.1" W x 11.3" D (216mm x 790mm x 287mm)
Product Weight (Each)	35 lbs. (15.9kg)

Troubleshooting

HDMI-ARC has **No** output.

- Ensure that the connected source is set to 2ch PCM
- Select the ARC input on the TV to re-establish ARC connection.
- Select another source on the TV or L75ms and then switch back to HDMI.

Restoring Factory Defaults

The L75ms can be reset to factory defaults should the need to arise. This will erase all settings for Network and Bluetooth requiring that all connections be reconfigured.

Press & Hold >3 sec until selection indicators on top panel flash.

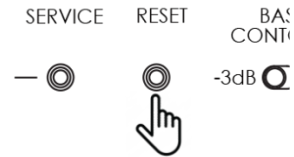

Updating Firmware

Software updates for the L75ms are via OTA (Over the Air) updates through Google Home. This occurs when you first connect to the L75ms or when it is connected to for wireless streaming. Contact customer support for updates on devices that have Wi-Fi or Bluetooth disabled.

Trademarks and Licenses



Apple®, AirPlay® and the AirPlay Logo™, iPod®, iPhone® and iPad® are trademarks of Apple Inc., registered in the U.S. and other countries. App Store is a service mark of Apple Inc.

AirPlay 2 works with iPhone®, iPad®, and iPod touch® with iOS 11.4 or later, Mac with OS X® Mountain Lion or later, and PC with iTunes® 10.2.2 or later.



The Spotify software is subject to third party licenses that can be found here:

<https://developer.spotify.com/legal/third-party-licenses/>



The Wi-Fi CERTIFIED™ logo is a registered trademark of Wi-Fi Alliance®.



Google, Google Play, Chromecast, and other related marks are trademarks of Google LLC. The Google Assistant requires an internet connection and is not available in certain countries and languages. Availability and react of certain features and services are device, service, and network-dependent and may not be available in all areas. Controlling certain devices in your home requires compatible smart devices. Subscriptions for services and applications may be required and additional terms, conditions and/or charges may apply.



HDMI, the HDMI logo and High-Definition Multimedia Interface are trademarks or registered trademarks of HDMI Licensing LLC.

MP3

MPEG Layer-3 audio decoding technology licensed from Fraunhofer IIS and Thomson multimedia.

FLAC Decoder Copyright © 2000, 2001, 2002, 2003, 2004, 2005, 2006, 2007, 2008
Josh Coalson

- Redistribution and use in source and binary forms, with or without modification, are permitted provided that the following conditions are met:
- Redistribution of source code must retain the above copyright notice, this list of conditions and the following disclaimer.
- Redistributions in binary form must reproduce the above copyright notice, this list of conditions and the following disclaimer in the documentation and/or other materials provided with the distribution.
- Neither the name of the Xiph.org Foundation nor the names of its contributors may be used to endorse or promote products derived from this software without specific prior written permission.

Flac

THIS SOFTWARE IS PROVIDED BY THE COPYRIGHT HOLDERS AND CONTRIBUTORS 'AS IS' AND ANY EXPRESS OR IMPLIED WARRANTIES, INCLUDING, BUT NOT LIMITED TO, THE IMPLIED WARRANTIES OF MERCHANTABILITY AND FITNESS FOR A PARTICULAR PURPOSE ARE DISCLAIMED. IN NO EVENT SHALL THE FOUNDATION OR CONTRIBUTORS BE LIABLE FOR ANY DIRECT, INDIRECT, INCIDENTAL, SPECIAL, EXEMPLARY, OR CONSEQUENTIAL DAMAGES (INCLUDING, BUT NOT LIMITED TO, PROCUREMENT OF SUBSTITUTE GOODS OR SERVICES; LOSS OF USE, DATA, OR PROFITS; OR BUSINESS INTERRUPTION) HOWEVER CAUSED AND ON ANY THEORY OF LIABILITY, WHETHER IN CONTRACT, STRICT LIABILITY, OR TORT (INCLUDING NEGLIGENCE OR OTHERWISE) ARISING IN ANY WAY OUT OF THE USE OF THIS SOFTWARE, EVEN IF ADVISED OF THE POSSIBILITY OF SUCH DAMAGE.



Harman International Industries, Incorporated.
8500 Balboa Blvd, Northridge CA 91329 United States.

European Representative: Harman International Industries, Incorporated.
EMEA Liaison Office, Danzigerkade 16G, 1013 AP Amsterdam, The Netherlands.

UK Business Address: Ground Floor, Westside 2, London Road, Apsley, Hemel Hempstead,
Hertfordshire, HP3 9TD, United Kingdom.

© 2022 Harman International Industries, Incorporated. All Rights Reserved.

JBL is a trademark of Harman International Industries, Incorporated registered in the United States and other countries.

Features, Specifications, and Appearance subject to change without notice.