

# 5000 Series Loudspeakers White Paper

## Continuous Curve Cone

The profile of a bass/mid driver cone has always been a compromise. Whilst a straight conic profile has benefits at bass frequencies, it exhibits undesirable break-up modes that will restrict its higher frequency range. A flared cone is a better option to control the cone break-up towards higher frequencies, however the flare shape will not hold its rigidity at low frequencies so well as a straight conic shape, particularly at the outer diameter.

The profile of the unique Continuous Curve Cone<sup>®</sup> (CCC) is the result of a Q Acoustics multi-disciplinary team research project to investigate a new, multi-radius complex curve contour cone profile. The goal was to design a profile that would exhibit 'best of both' benefits with the bass characteristics of a straight conic profile, and with the mid frequency control of a flared profile.

At the outset, the project began by computer-modelling a sample drive unit with a spherical cone driven by a large coupler. This is the 'anchor model' shown in Figure 1. The anchor model and its respective measurements form the starting point for any kind of new development. To start the development process the anchor-model's simulation results must accurately predict the measurements of the sample. Therefore the geometry and the material properties of each soft-part (cone, coupler, surround, spider, voice-coil) have to be identified and adjusted to achieve an accurate alignment between the measurements and the simulation results.

Figure 2 shows a 2-radius cone profile, the first step towards the CCC profile. This was the first shape for which tooling was made and samples were built. The measurement results of each sample were used to refine the Finite Element Analysis (FEA) model and thus increase the prediction accuracy.

The next phase was to investigate the integration of the multiple radii into a single, smooth, continuous curve profile. An example of a continuous curve cone is shown in Figure 3. Computer modelling continued until the performance of these smooth transition CCC cone profiles had been optimised and were ready to prototype and test. Further modelling and prototypes of adjustments to that profile yielded even better performance.

With prototypes of a refined new CCC cone now available, the final phase of the drive unit design could begin as, in common with all other Q Acoustics drive units, they are clean sheet designs. Every component part of a Q Acoustics drive unit is a unique design and not a standard part in any way. Performance trials continued to optimise components such as the roll surround, spider and the interface between these components and the CCC cone to achieve the required performance levels and also durability. Between the start and the finish of the project sixteen different samples had been evaluated. The variations covered the cone-shape, surround-thickness, spider-geometry and the optional use of a coupler between the cone and the voice coil. The 125 mm drive unit had now reached a stage where manufacturing tooling could begin, but it had become apparent that the profile of CCC cannot just be scaled for different diameter drive units. Work commenced to create derivative profiles for both larger and smaller diameter cones. With accurate computer models this had become a much quicker process.

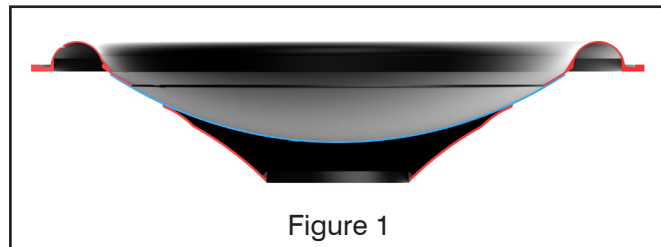

Figure 1

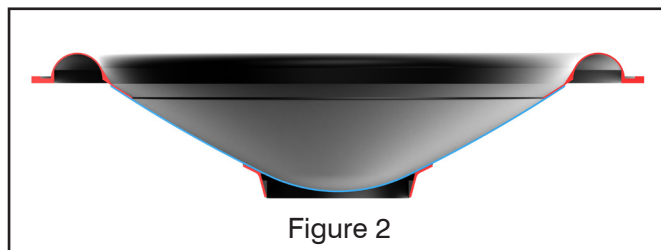

Figure 2

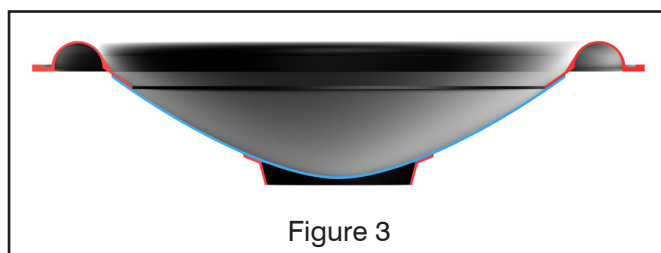

Figure 3

## Technical benefits of CCC

With excellent dispersion, a drive unit with a CCC cone features a well controlled frequency response which enables smooth integration with the tweeter using gentle slope, low order crossovers.

Frequency and amplitude linearity performance are exceptional for a drive unit in this class as shown in the plot of the 5000 series 125 mm driver in Figure 4. Harmonic artefacts can be seen to be well below the 0.2 % limit line for most of the critical midband.

A further side benefit of CCC implementation is that the cone is more resilient to modulation by standing-waves within the cabinet.

## CCC benefits in audition

The benefits of a drive unit featuring CCC are not subtle, and can particularly be heard as excellent bass dynamics, significantly better than single radius flared cones. The CCC cone profile does exhibit the best characteristics of a simple, straight conic profile, but without its undesirable break-up modes.

The tight, damped bass sound of loudspeaker designs featuring CCC drive units enables more flexibility in placement of speakers near the boundaries of the listening room. Subjectively the drive units appear to be more in control of the room space, rather than the room exciting the loudspeaker.

## Conclusion

It is rare that a genuine advance is made to one of the fundamental design elements of a loudspeaker drive unit. Most progress in loudspeaker design is incremental, based on the use of more advanced materials etc, but the CCC profile has successfully addressed shortcomings in one of the basic geometrical elements of drive unit design.

Not to be confused with other one-piece cone designs that simply integrate a dust-cap into the cone profile, the final CCC profile delivers genuine technical performance benefits over traditional industry standard cone profiles.

In this case the CCC project has achieved the team's objective to design a loudspeaker cone that will deliver the best characteristics of both straight and flared cones.

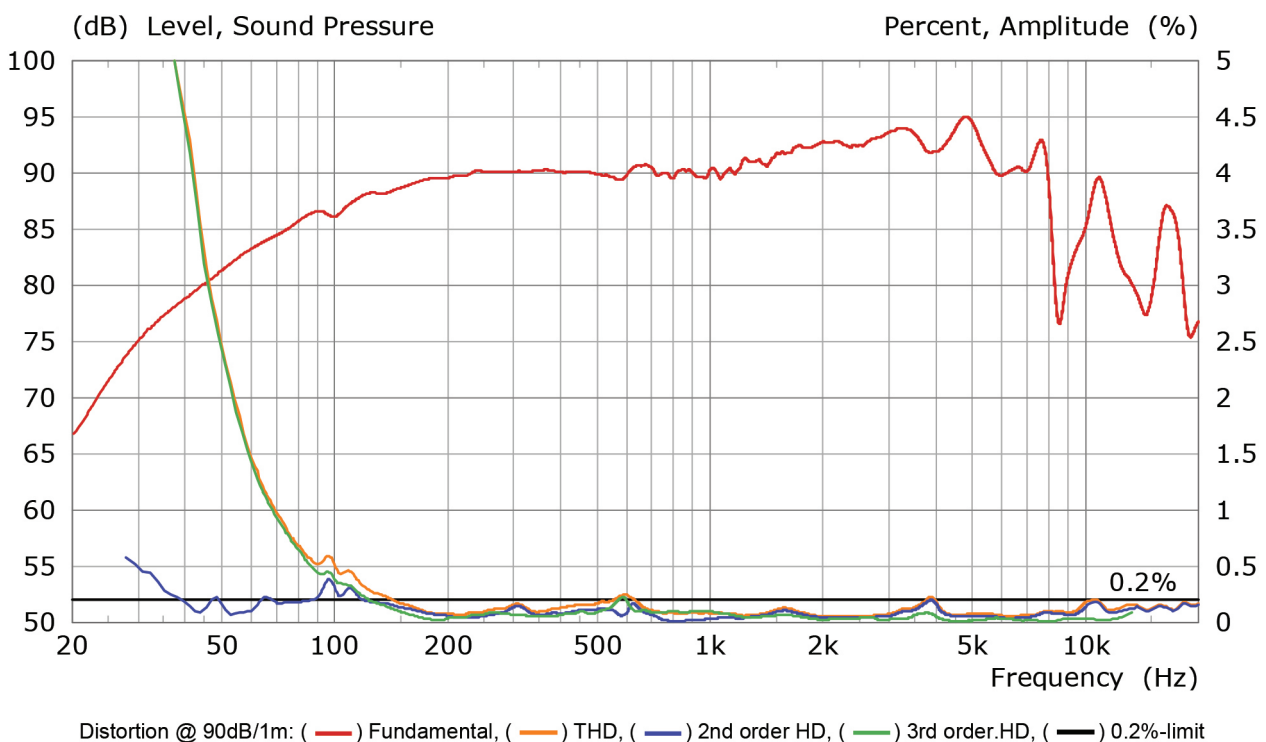

Figure 4

## Drive units

### Mid/Bass drive unit construction

At the heart of the 5000 series and one of the most important features of the range is the new Continuous Curve Cone® (CCC) bass/mid driver cone design.

All models in the 5000 range feature the new, Q Acoustics CCC cone profile in bass/mid drivers sized:

- 110 mm (5010 and 5090)
- 125 mm (5020 and 5040)
- 150 mm (5050).

In the 5000 range the CCC geometry requires good motor strength and high Bl. A side effect of these powerful motors is a near fully saturated pole plate. This contributes to the low harmonic distortion performance as there is less unsaturated iron to be modulated by the coil flux.

The substantial magnets:

- 100 mm x 20 mm (5010 and 5090)
- 110 mm x 20 mm (5020, 5040 and 5050)

are coupled to large voice coils:

- 30.5 mm diameter (5010, 5020, 5040, 5090)
- 35.5 mm diameter (5050)

which increase motor strength resulting in a minimum 50 % increase in power handling over a comparable driver with 25.4 mm voice coil. The voice coil is wound from Copper-Clad Aluminium Wire (CCAW) over a glass fibre former. Despite the large diameter, the lightweight CCAW wire keeps the moving mass low while the non-conductive former completely eliminates eddy currents which can otherwise be induced in aluminium voice coil formers.

The cone material, the voice coil construction and the FEA optimised suspension system are all design features inherited from the Q Acoustics Concept mid/bass driver.

The low damping, pure nomex spider results in good dynamic behaviour, especially for small signals. FEA computer modelling techniques were used to optimise the design of the spider and surround for a symmetric compliance characteristic and to achieve best alignment of the suspension with the new motor system.

Key features are shown in Figure 5, a cutaway view of the drive unit construction.

Figure 5

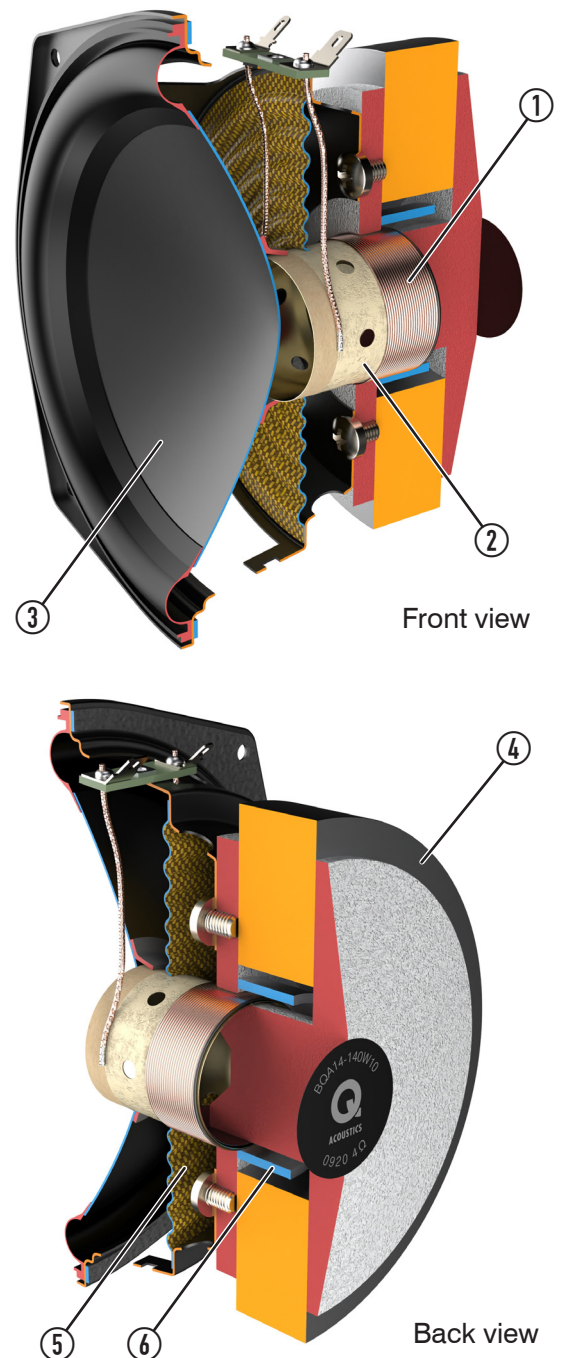

1. CCAW wire voice coil
2. Glass-fibre former
3. Cone with CCC profile
4. Substantial magnet
5. Pure nomex spider
6. Aluminium demodulation ring

## Mid/Bass drive unit performance

The measured  $Bl(x)$  and  $Cms(x)$  graphs shown in Figures 6 and 7 prove that the targeted design goals have been achieved.

To complete the design, an aluminium demodulation ring is mounted underneath the pole-plate for reduced inductance induced modulation distortion. In Figure 8 the measured coil inductance  $L(x)$  is plotted as a function of excursion. The symmetrical shape of this plot confirms that the 5000 series mid/bass driver performs well in this regard.

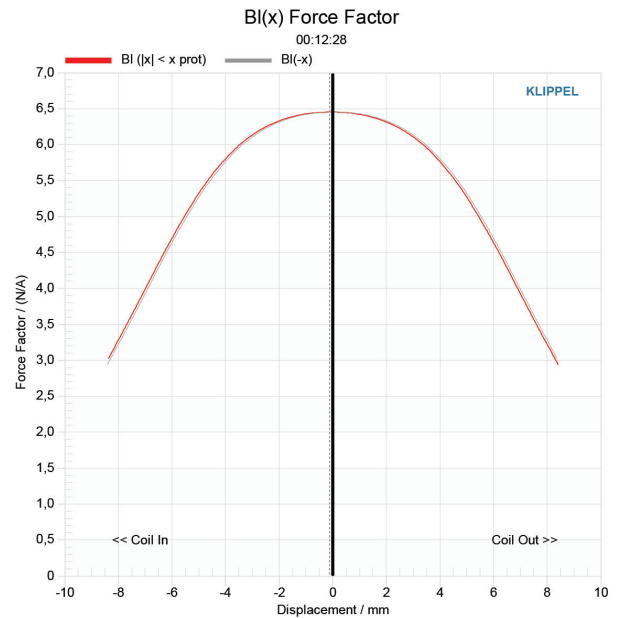

Figure 6

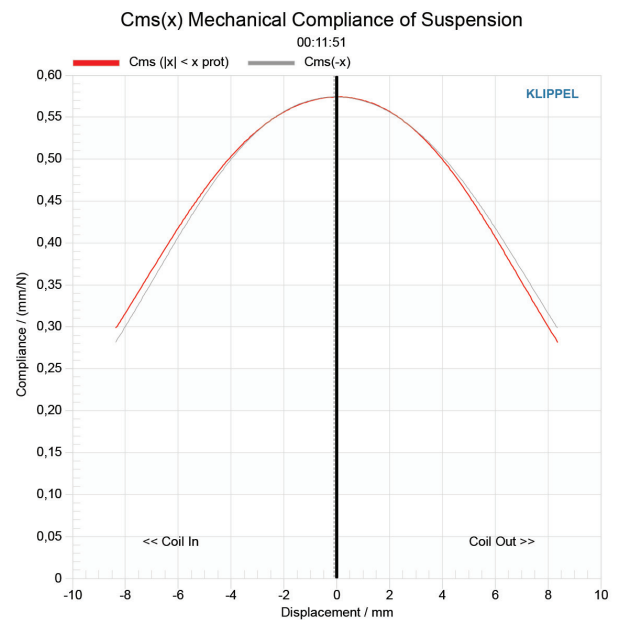

Figure 7

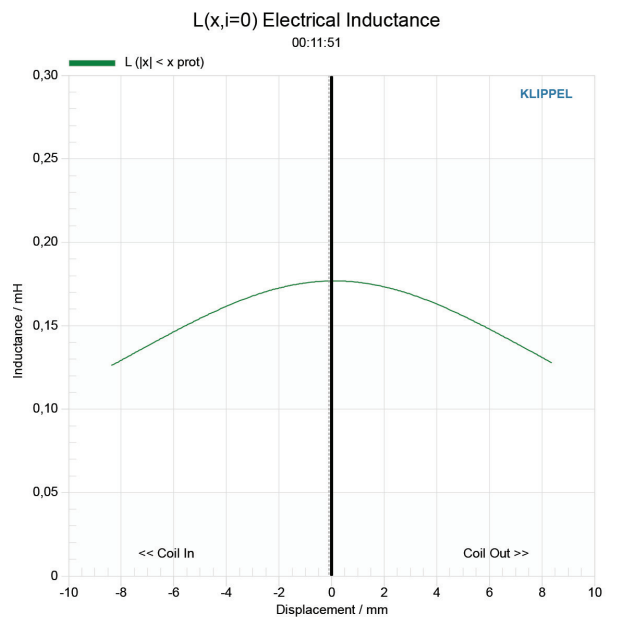

Figure 8

## High frequency drive unit construction

The tweeter benefits directly from the Concept range tweeter design. The dome fabric, compact neo-motor, symmetrical load cavity and inverted roll surround are all design features inherited from the Concept series.

The tweeter is hermetically sealed to prevent modulation by internal pressures from within the cabinet and mechanically isolated (floating) from the front baffle.

The motor system is a compact neo-motor to minimise the spacing within the drive unit array of the 5040, 5050 and 5090.

The design features optimised acoustic rear wave termination from inside and outside the voice coil diameter. The inner chamber is carefully vented into the outer housing for lower distortion in the cross-over region.

Key features are shown in Figure 9, a cutaway view of the drive unit construction.

Figure 9

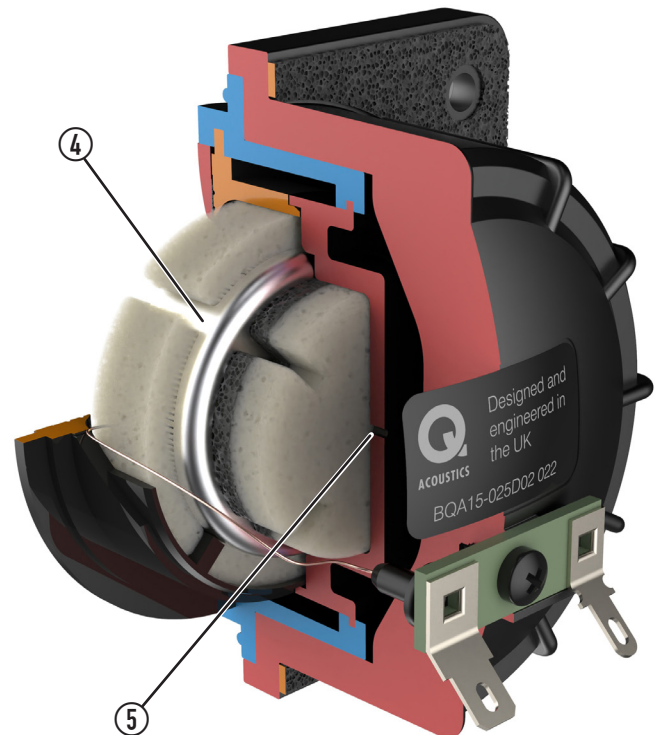
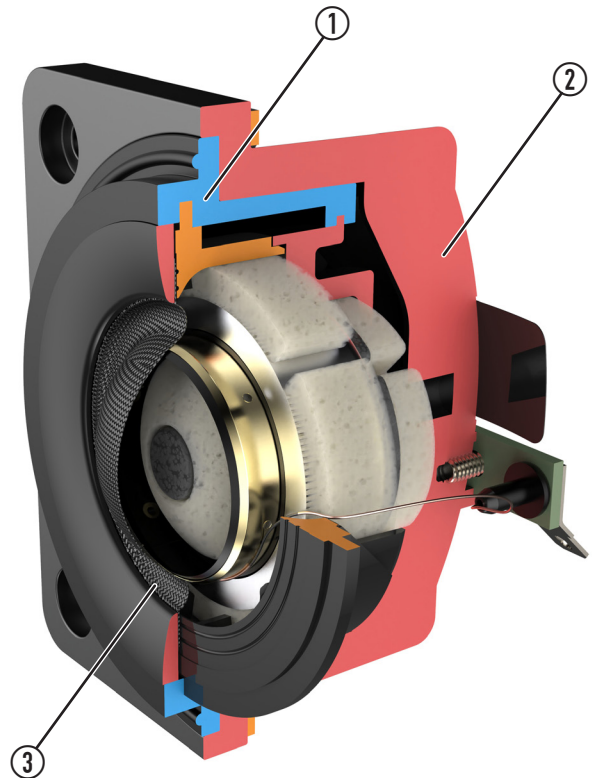

1. Mechanical isolation
2. Sealed housing
3. Inverted roll surround
4. Compact neo-motor
5. Inner chamber vent

## High frequency drive unit performance

Designed with a 700 Hz resonant frequency the bandwidth of the tweeter is optimised to allow a low crossover point close to 2 kHz. This maximises the off axis performance of the Mid Woofer-Tweeter-Mid Woofer (MTM) design of 5040, 5050 and 5090 and maintains phase consistency for seamless integration through the crossover region. Figure 10 shows the on-axis SPL and THD measured at 90 dB/1m.

A measured THD value of less than 0.5 % for frequencies above 1.5 kHz confirms that this is a low distortion, high excursion tweeter well suited to a low crossover frequency.

The concave roll-surround design delivers a broader directivity and phase-coherent off-axis radiation.

A shallow wave guide improves the directivity of the tweeter in the 5-15 kHz region as shown in the directivity diagram in Figure 11.

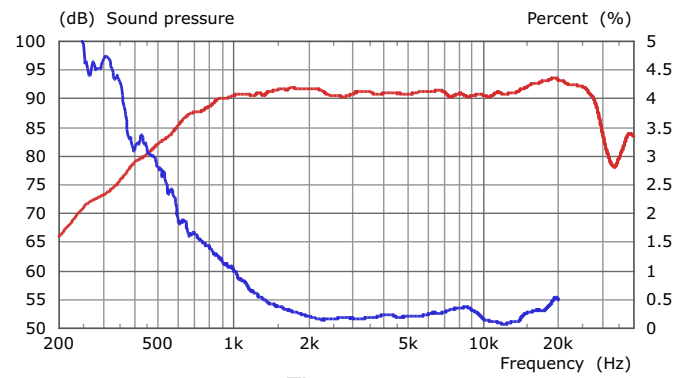

Figure 10

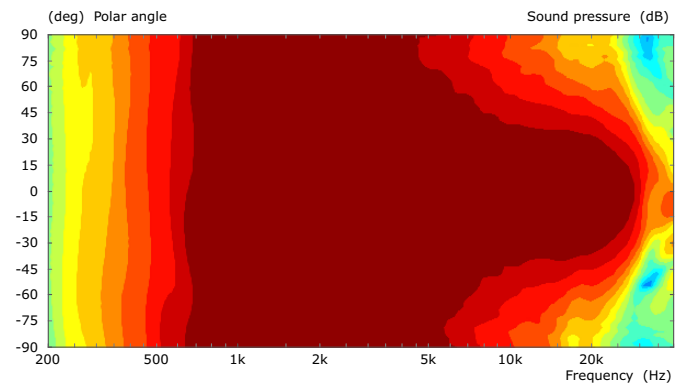

Figure 11

## **Cabinet**

---

### **Cabinet construction**

The cabinets for the 5010 and 5090 are constructed from 18mm Medium Density Fibreboard (MDF), increasing to 20 mm for the larger cabinets of the other models in the range. All baffles are 25 mm High Density Fibreboard (HDF).

The baffle fronts are laminated with a layer of butyl rubber and an acrylic trim, providing a constrained layer damping construction to suppress vibration occurring in the baffles. The bonded trim and magnetic fixings for the grille enable a cosmetically clean and acoustically smooth front presentation to be achieved, uninterrupted by any fixings.

The grilles are lightweight, open-frame designs to maximise their transparency.

All tower models are supplied with adjustable spikes and protective spike covers that can be fitted if required to protect flooring.

The 5040 and 5050 tower models feature aluminium stabilisers which are anodised in a contrasting colour and feature top adjustable spikes for easier levelling.

## P2P bracing

Q Acoustics Point to Point (P2P) bracing is employed in all cabinets of the 5000 series.

P2P bracing is a cabinet bracing system that supports specific parts of the cabinet that need to be stiffened without coupling unwanted energy or exacerbating cabinet structure modality. P2P bracing will improve the focus of the stereo image and provide additional soundstage image.

The illustrations show how effective this methodology has become. Relative displacement simulations of 5050 cabinets without P2P bracing are shown in the left images in Figures 12, 13 and 14 at test frequencies of 376 Hz, 474 Hz and 532 Hz respectively.

Where displacement is greatest the area is coloured towards the red end of the spectrum and where it is least it is coloured towards the blue end. Conventional bracing would allow this movement to be transferred to adjacent panels, but Q Acoustics P2P allows the design team to apply bracing only in exactly the correct places.

When the simulations are repeated on the enclosures with P2P bracing, shown in the right images in Figures 12, 13 and 14, the deformation maps show how effectively the cabinet resonances have been reduced.

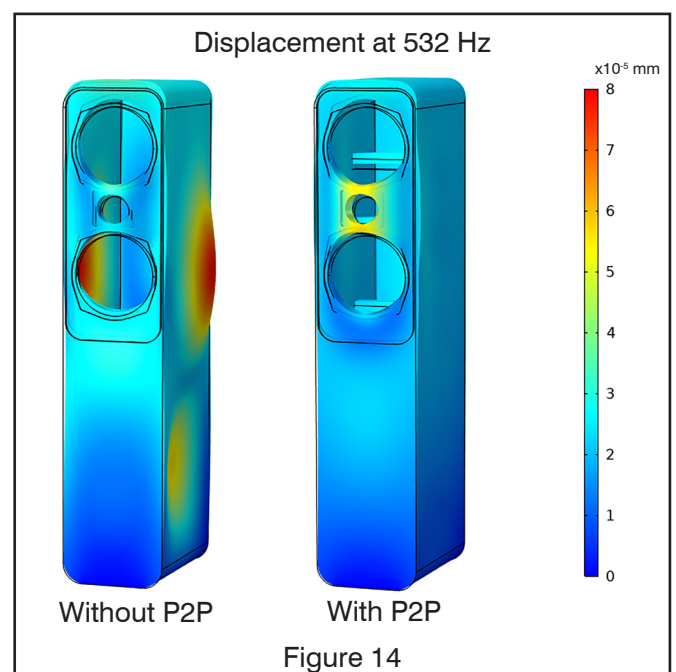
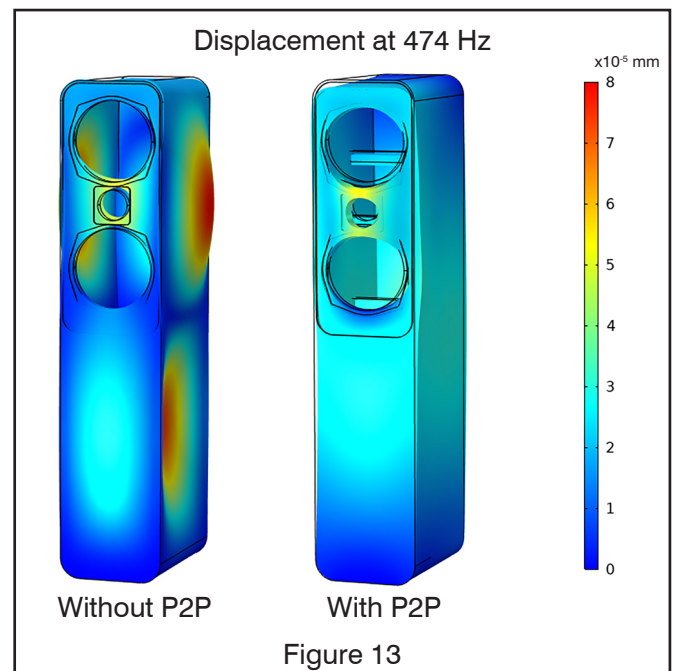
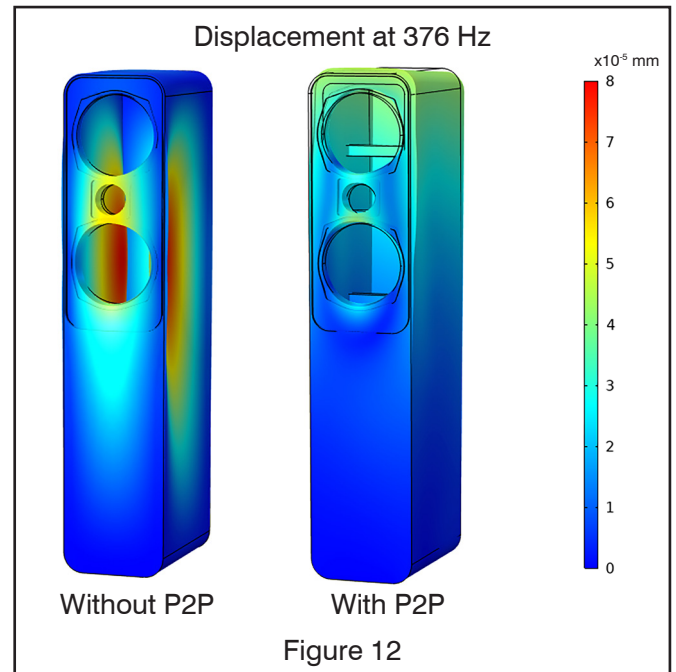



### Standing wave pressure equaliser tubes

The proportions of all tower format speakers can introduce undesirable standing waves within their cabinets. The 5040 and 5050 towers therefore include Helmholtz Pressure Equalisers (HPE) designed to convert pressure to velocity and reduce the overall pressure gradient within the enclosure.

The cutaway in Figure 15 shows the installation of HPE technology in a 5050 cabinet.

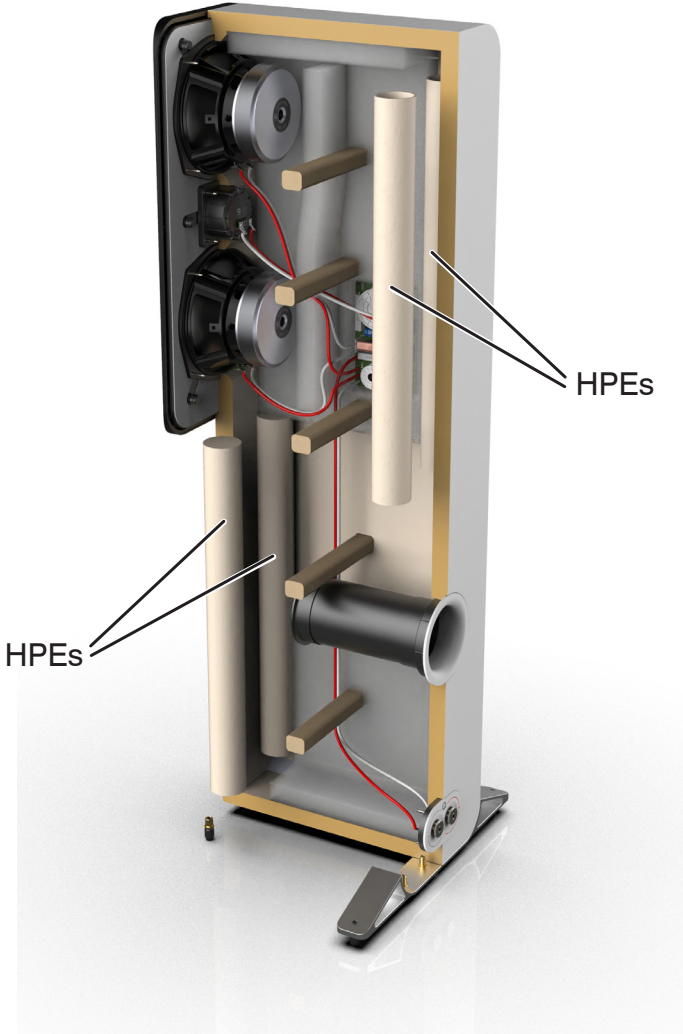

Figure 15

Figure 16 shows a sectional pressure map of a typical tower loudspeaker cabinet with and without HPE.

The benefits of HPE technology can be clearly seen, significantly reducing the pressure gradient in the cabinet.

The benefits of HPE technology can also be measured in the frequency response curves. Figure 17 shows the frequency response of the 5050 measured without HPE (note the dip in the frequency response).

Figure 18 shows the frequency response with HPE. The dip is now resolved.

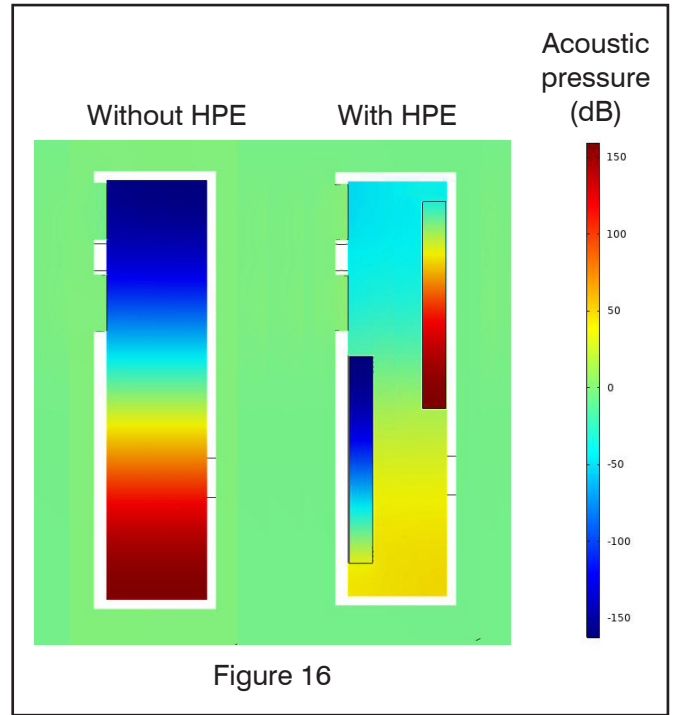

Figure 16

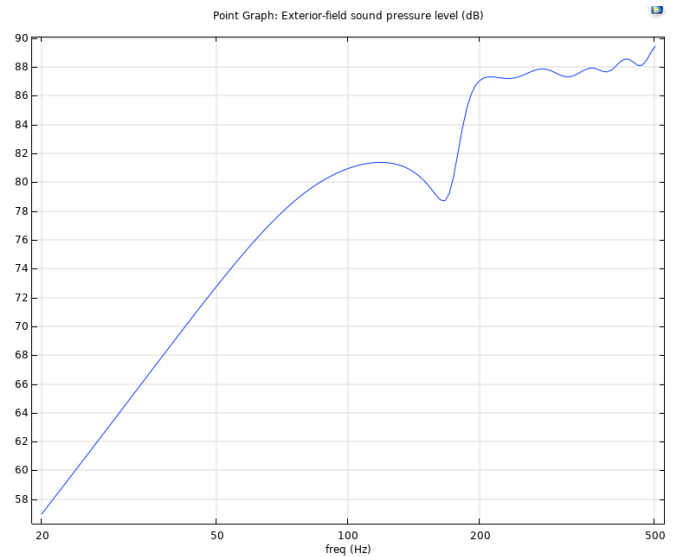

Figure 17

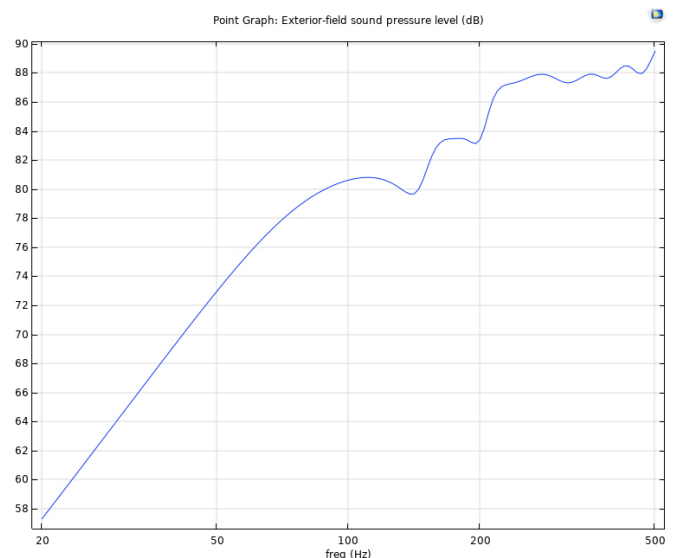

Figure 18

## Crossover

---

The crossovers are modified 2nd order designs with crossover points set at 2.1 kHz for the 5090 and 2.5 kHz for the other models. The lower 2.1 kHz crossover point is particularly beneficial for horizontal dispersion in the 5090 design.

The load impedance is set at a nominal 6 Ohms.

The crossover uses high grade metallized polyester film capacitors and low saturation air core inductors in the signal path. The resistors are high power wire-wound types, bifilar wound for ultra-low parasitic inductance.

## Terminal panel

---

A new terminal panel features metal securing nuts for low contact resistance and compatibility with 4 mm plugs, wires or spade tags. The terminals are very low profile to keep plugs close to the speaker back face, providing a tidy appearance and enabling the speaker to be placed closer to the back wall if required.

## Finish options

---

The 5000 series is available in four durable, high quality finishes - satin black, satin white, santos rosewood and holme oak.

## Accessories

---

A range of Q Acoustics accessories are available to complete the installation of the 5000 series including: 3000FSi stands for the 5010 and 5020.







3000WB wall bracket for the 5010.



WB75 wall bracket for the 5020 and 5090.



## Specifications

	5010	5020	5040	5050	5090
					
Bass unit	1 x 110 mm (4.5 in)	1 x 125 mm (5.0 in)	2 x 125 mm (5.0 in)	2 x 150 mm (6.0 in)	2 x 110 mm (4.5 in)
Treble unit	1 x 25 mm (1.0 in)	1 x 25 mm (1.0 in)	1 x 25 mm (1.0 in)	1 x 25 mm (1.0 in)	1 x 25 mm (1.0 in)
Frequency response (-6dB)	56 Hz - 30 kHz	53 Hz - 30 kHz	39 Hz - 30 kHz	TBC Hz - TBC kHz	57 Hz - 30 kHz
Nominal impedance	6 Ω	6 Ω	6 Ω	TBC Ω	6 Ω
Minimum impedance	3.3 Ω	3.3 Ω	3.0 Ω	TBC Ω	3.2 Ω
Sensitivity (2.83V @ 1kHz)	86.3 dB/w/m	87.8 dB/w/m	91.5 dB/w/m	TBC dB/w/m	90.5 dB/w/m
Recommended amplifier power	15 - 90 W	25 - 100 W	25 - 150 W	TBC W	25 - 150 W
Crossover frequency	2.5 kHz	2.5 kHz	2.5 kHz	TBC kHz	2.1 kHz
Effective volume	5.0 L	6.8 L	27.0 L	39.7 L	7.8 L
Dimensions (per loudspeaker) HxWxD	264 x 160 x 263 mm (10.4 x 6.3 x 10.4 in)	284 x 180 x 293 mm (11.2 x 7.1 x 11.5 in)	Inc spikes and stabiliser: 967 x 361 x 293 mm (38.1 x 14.2 x 11.5 in)	Inc spikes and stabiliser: 1017 x 386 x 336 mm (40.0 x 15.2 x 13.2 in)	164 x 430 x 243 mm (6.5 x 16.9 x 9.6 in)
Weight (per loudspeaker)	5.6 kg (12.3 lbs)	7.0 kg (15.4 lbs)	18.0 kg (39.7 lbs)	TBC kg (TBC lbs)	8.5 kg (18.7 lbs)

### Not for publication

Actual Power Handling	30 W	35 W	50 W	TBC W	50 W
Actual Impedance	4 Ω	4 Ω	4 Ω	TBC Ω	4 Ω