

USER MANUAL

_JUP-8 V4

ARTURIA

_The sound explorers

Special Thanks

DIRECTION

Frédéric Brun Kevin Molcard

DEVELOPMENT

Yann Burrer	Raynald Dantigny	Timothée Behety	Antoine Moreau
Marie Pauli	Corentin Comte	Mathieu Nocenti	Markus Bollinger
Alessandro De Cecco	Pierre-Lin Laneyrie	Simon Conan	Kevin Arcas
Stefano D'Angelo	Alexandre Adam	Loris De Marco	Geoffrey Gormond
Samuel Limier	Baptiste Aubry	Cyril Lepinette	Rasmus Kürstein

DESIGN

Edouard MADEUF	Shaun Ellwood	Philipp Roller
Baptiste Legoff	Florian Rameau	Morgan Perrier

SOUND DESIGN

Victor Morello	Dave Polich	Ed Ten Eyck	Vangelis Vargas
Jean-Michel Blanchet	Mark Gijisman	Tom Hall	
Lily Jordy	Torben Hansen	Simon Gallifet	

TESTING

Maxime Audfray	Arnaud Barbier	Thomas Barbier	Christophe Tessa
Mathieu Bosshardt	Germain Marzin	Florian Marin	

BETA TESTING

Terry Marsdsen	Chuck Zwicky	Pagnier	Dwight Davies
Marco Correia	Peter Tomlinson	Fernando Manuel	Angel Alvarado
Gary Morgan	David Harman	Rodrigues	Paolo Negri
Gustavo Bravetti	Guillaume Hernandez	Andrew Henderson	Dan Tinen

MANUAL

Dan Tinen (author)	Camille Dalemans	Charlotte Metais
Jason Valax (author)	Minoru Koike	Gala Khalife
Roger Lyons	Vincent Le Hen	Holger Steinbrink

© ARTURIA SA - 2020 - All rights reserved.

26 avenue Jean Kuntzmann
38330 Montbonnot-Saint-Martin
FRANCE

www.arturia.com

Information contained in this manual is subject to change without notice and does not represent a commitment on the part of Arturia. The software described in this manual is provided under the terms of a license agreement or non-disclosure agreement. The software license agreement specifies the terms and conditions for its lawful use. No part of this manual may be reproduced or transmitted in any form or by any purpose other than purchaser's personal use, without the express written permission of ARTURIA S.A.

All other products, logos or company names quoted in this manual are trademarks or registered trademarks of their respective owners.

Product version: 2.0

Revision date: 14 November 2022

Thank you for purchasing JUP-8 V4!

This manual covers the features and operation of Arturia's JUP-8 V4, the latest in a long line of powerful virtual instruments.

Be sure to register your software as soon as possible! When you purchased JUP-8 V4 you were sent a serial number and an unlock code by e-mail. These are required during the online registration process.

Special Messages

Specifications Subject to Change:

The information contained in this manual is believed to be correct at the time of printing. However, Arturia reserves the right to change or modify any of the specifications without notice or obligation to update the software that has been purchased.

IMPORTANT:

The software, when used in combination with an amplifier, headphones or speakers, may be able to produce sound levels that could cause permanent hearing loss. DO NOT operate for long periods of time at a high level or at a level that is uncomfortable. If you encounter any hearing loss or ringing in the ears, you should consult an audiologist.

Introduction

Congratulations on your purchase of Arturia's JUP-8 V4!

We'd like to thank you for purchasing JUP-8 V4, a virtual instrument recreation of the classic Roland Jupiter-8 synthesizer, which took the polyphonic synthesizer market by storm in 1981. It was the absolute pinnacle of analog synthesizer technology at the time, light-years ahead of the competition. It was more reliable than its contemporary competition, with a more consistent sound was from unit to unit. Therefore it was very attractive for stage and studio use.

In the 1980s, the electro-pop community quickly put the qualities of the Jupiter-8 to use, recording hit after hit. "Relax" by Frankie Goes to Hollywood was produced incorporating a Jupiter 8, and players such as Vince Clarke, Howard Jones, John Foxx, and Martyn Ware were also using it. The path to the classic status of the Jupiter started there.

Other artists who have used the Jupiter-8 include: Tangerine Dream, Underworld, Jean Michel Jarre, Depeche Mode, Prince, Gary Wright, Adrian Lee, Heaven 17, Kitaro, Elvis Costello, Tears for Fears, Huey Lewis and the News, Journey, Moog Cookbook, Yes, Devo, Freddy Fresh, Simple Minds, Jan Hammer, and BT. Now it's your turn.

The JUP-8 V4 is capable of creating very versatile sounds. You can easily make "fat" or "crystal" sounds with it. Offering oscillator sync, cross modulation, a switchable 12dB/24dB resonant filter and polyphonic portamento, the sound design opportunities are endless. You can easily save and load patches, and the 44 original factory presets, used on many recordings, are included. Even a superb arpeggiator is included.

Still, technology has advanced a great deal in the past 40 years, so we added some features that would have been impossible or prohibitively costly in 1981, under Arturia's Advanced Extensions panel:

- **more modulations options** including two more LFOs and an advanced modulation mixer that lets you route and mix from 10 different sources
- **an onboard 32-note sequencer**, plus a 32-segment modulation sequencer
- **the ability to route velocity**, aftertouch, the Mod Wheel, and keyboard tracking to any parameter
- **built-in digital effects** including reverb, chorus, delay, flanger, phaser, overdrive distortion, EQ, and stereo pan

The options for stacking voices, one of the hallmarks of the Jupiter sound originally, are expanded beyond what the original hardware offered.

Arturia has a passion for excellence, and JUP-8 V4 is no exception. Listen to the preset sounds, tweak a few controls, skim through the features, or dive as deep as you like; it is easy to understand and use. We are confident that the JUP-8 V4 will be a valuable addition to your instrument collection, and that you'll have a lot of fun with it.

Be sure to visit the www.arturia.com website for information about all of our other great hardware and software instruments. They have become indispensable, inspiring tools for musicians around the world.

Musically yours,

The Arturia team

Table Of Contents

1. ACTIVATION & FIRST START.....	3
1.1. Computer system requirements	3
1.2. How to Install and Activate the JUP-8 V4 on your computer	3
1.2.1. Download and install the software	3
1.2.2. Activate the JUP-8 V4 License using the Arturia Software Center (ASC).....	4
1.3. How to select the instrument's MIDI input and audio outputs (standalone mode).....	5
1.3.1. Audio and MIDI settings: Windows.....	5
1.3.2. Audio and MIDI settings: macOS.....	7
1.3.3. Using JUP-8 V4 as an instrument plug-in in a DAW.....	7
2. Quick Start: How to play JUP-8 V4 Presets	8
2.1. Sections of the visual interface.....	8
2.2. Preset selection tools in upper toolbar.....	8
2.2.1. Scrolling through presets using the upper toolbar	9
2.2.2. Preset Library.....	10
2.2.3. JUP-8 V4 menu (top left corner of app window).....	11
3. Quick Tour of the Arturia JUP-8 V4.....	13
3.1. How to display the Advanced Panel.....	13
3.2. Right sidebar	14
3.2.1. Settings	15
3.2.2. MIDI Controllers.....	16
3.2.3. Macro	17
3.3. Top panel general controls.....	19
3.3.1. Volume	19
3.3.2. Master Tune.....	19
3.3.3. Unison Detune.....	19
3.3.4. Pan Spread	20
3.3.5. Portamento.....	20
3.4. Virtual keyboard area	20
3.4.1. The virtual keyboard.....	20
3.4.2. Parameter help and value popups.....	21
3.4.3. Bender	21
3.4.4. Modulation Wheel (LFO MOD).....	21
3.4.5. Arpeggiator	22
3.4.6. VOICE ASSIGN	24
3.4.7. HOLD.....	25
3.4.8. Bottom toolbar	25
4. How Analog Synthesis Works.....	28
4.1. What each module does	28
4.1.1. VCO.....	28
4.1.2. VCF.....	28
4.1.3. VCA.....	29
4.2. Audio and modulation signal paths.....	29
4.3. VCOs generate the sound.....	30
4.4. VCF (Voltage Controlled Filter) filters the sound.....	31
4.4.1. The difference between HPF CUT and VCF CUT.....	31
4.4.2. Envelope choice and Resonance (RES).....	31
4.5. VCA (Voltage-Controlled Amplifier) controls the amplitude of the sound over time.....	31
4.6. Summary.....	32
5. VCOs.....	33
5.1. VCOs 1 and 2	33
5.1.1. Differences between the oscillators	33
5.2. Source Mix control	33
5.3. VCO-1 Controls.....	34
5.4. VCO-2 Controls	34
5.4.1. Noise waveform.....	34
5.5. About waveforms.....	35
5.5.1. The RECTANGLE wave and PULSE WIDTH Modulation (PWM).....	35
5.6. SYNC	37
5.7. CROSS	38
5.7.1. Frequency Modulation.....	38

5.7.2. Noise modulation.....	38
5.7.3. Using VCO-2 as an LFO.....	38
6. HPF and VCF Filters, VCA, and Envelopes.....	39
6.1. HPF (High Pass Filter).....	39
6.2. VCF (Voltage Controlled Filter).....	40
6.3. VCA (Voltage-Controlled Amplifier).....	41
6.4. Envelopes.....	42
7. LFO and VCO Modulator Controls.....	43
7.1. LFO (Low-Frequency Oscillator).....	43
7.2. VCO Modulator.....	44
8. Advanced Panel.....	46
8.1. Advanced Modulations.....	46
8.1.1. LFO 2 and LFO 3.....	46
8.1.2. Modulation Mixer.....	50
8.2. Sequencer.....	53
8.2.1. Notes and Mod Sequencer shared parameters.....	54
8.2.2. Notes Sequencer.....	56
8.2.3. Mod Sequencer.....	59
8.3. Keyboard.....	61
8.3.1. Adjusting the performance modulation curves.....	61
8.4. Effects.....	62
8.4.1. Series or parallel module routing.....	62
8.4.2. Selecting an effect.....	63
8.4.3. Enabling / disabling an effect.....	63
8.4.4. Editing the effects.....	64
8.4.5. Modulation Mixer FX Parameters.....	75
9. Dispersion.....	76
9.1. Dispersion modes: 1, 2, 3 and Custom.....	76
9.2. Dispersion trimpots.....	77
10. The Preset Browser.....	79
10.1. Browse Presets With MIDI Controller.....	79
10.2. Playlists.....	80
10.2.1. Add a playlist.....	80
10.2.2. Add a preset to the playlist.....	80
10.2.3. Re-order the presets in the playlist.....	80
10.2.4. Remove a preset from the playlist.....	80
10.2.5. Delete a playlist.....	80
11. Software License Agreement.....	81

1. ACTIVATION & FIRST START

1.1. Computer system requirements

Before installing JUP-8 V4, make sure that your computer hardware and operating system meets these minimum specifications:

Windows 8.1 or later (64bit)

- 4 GB RAM; 2.5 GHz CPU
- 1GB free hard disk space
- OpenGL 2.0 compatible GPU

Apple macOS 10.13 or later

- macOS 10.13 or later
- 4 GB RAM; 2.5 GHz CPU
- 1GB free hard disk space
- OpenGL 2.0 compatible GPU

You can use the stand-alone version of JUP-8 V4 or use it as an instrument plug-in within a 64-bit digital audio workstation as an Audio Units, AAX, VST 2.4 or VST 3 instrument.



1.2. How to Install and Activate the JUP-8 V4 on your computer

1.2.1. Download and install the software

The licenses for Arturia products are registered, from the Arturia website. Using your favorite web browser on the computer where you plan to use JUP-8 V4, go to

<https://www.arturia.com/myarturia>

Sign in to your Arturia account with your email and password.



If this is your first purchase, simply click on the **Create an account** icon and fill in the form.

Click on the **My Products** icon. Depending on how you bought the software, the product has already been dropped into your account, or you need to enter the Serial Number and Unlock Code delivered with your instrument.



If you want to activate the instrument on a computer that doesn't have internet access, that's OK. On a different computer that does have online access, click on the **Activate Product on an Offline Machine** link for the procedure.

Once the JUP-8 V4 is in your account, click on the **Download** button to download the software. If you bought it as part of a bundle like V Collection 8, you can either download all the instruments at once or click on **More info...** to download individual instruments. The installer package should automatically open a window; click **Install** and follow the usual steps for installing software on your system.



You can activate the software on up to five different machines. If you lose or sell your computer, don't forget to deactivate the license for that machine.

1.2.2. Activate the JUP-8 V4 License using the Arturia Software Center (ASC)

Once JUP-8 V4 has been installed, the next step is to activate your license for the software.

Find and open the application **Arturia Software Center** that was included in your JUP-8 V4 (or bundle) installation package.

- On an Apple Mac it's located in your Applications folder under: Arturia/Arturia Software Center
- On a PC it can be found by clicking on the bottom left corner Windows search icon.



If for some reason the ASC software wasn't installed with your JUP-8 V package, please go to this web page to download it: [Arturia Updates & Manuals](#)

The Arturia Software Center is on the first item on the Downloads list. Once you've located it, download the version of the installer that you need for your system:

For macOS 10.13+ use file extension ".pkg". For Windows 8.1 or later use file extension ".exe".

Follow the installation instructions.

1. Enter your Arturia account name and password into the ASC fields (or create one if you haven't already).
2. Scroll down to the My Products section of the ASC.
3. Click the **Activate** button.
4. Quit the Arturia Software Center program.

That's all there is to it!

1.3. How to select the instrument's MIDI input and audio outputs (standalone mode)

If you're going to use JUP-8 V4 as a standalone application (that is, not use it as an instrument plugin in a digital audio workstation like Pro Tools, Cubase, Digital Performer, etc.) you need to connect JUP-8 V to your computer's MIDI interface and audio interface. Here's how:

1.3.1. Audio and MIDI settings: Windows

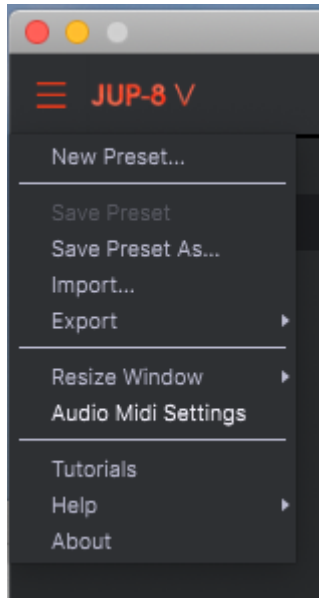

At the top left of the JUP-8 V4 stand-alone application window is a pull-down menu. It contains various setup options. Initially you will need to go to this menu and choose the Audio Settings option to get MIDI flowing in and sound flowing out.

You will then see the Audio MIDI settings window. This works in the same way on both Windows and macOS, although the names of the devices available to you will depend on the hardware you are using.

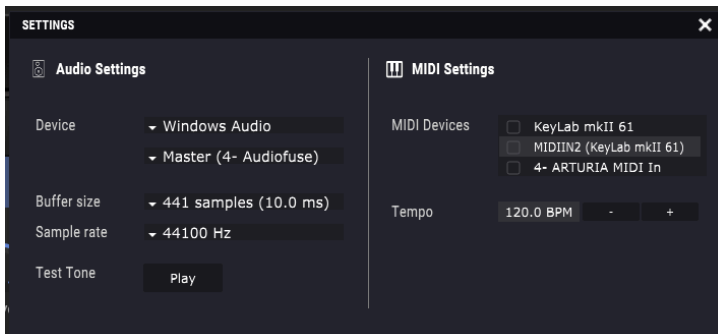

Starting from the top you have the following options:

- **Device** lets you choose which audio driver you want to use to route sound out of the instrument. This might be your computer's own driver like Windows Audio, or an ASIO driver. The name of your hardware interface may appear in this field.
- **Output Channels** lets you select which of the available outputs will be used for audio out from the software. If you only have two outputs, only two will appear as options. If you have more than two you can select a specific pair of outputs.
- The **Buffer Size** menu lets you select the size of the audio buffer your computer uses to calculate sound. A smaller buffer means lower latency time between pressing a key and hearing the note. A larger buffer means a lower CPU load as the computer has more time to think, but can result in a small latency (delay). Find the optimum buffer size for your system. A fast, modern computer should easily be able to operate at 256 or 128 sample buffer size without creating pops or clicks in the sound. If you are getting clicks, try raising the buffer a little. The latency time for each sample buffer setting in milliseconds is listed on the right hand side of this menu.
- The **Sample Rate** menu lets you set the sample rate at which audio is sent out of the instrument. The options here will depend on the capability of your audio interface hardware though even most computers' own hardware can operate at up to 48kHz which is perfectly fine. Higher sample rates use more CPU power so unless you have a good reason to go up to 96kHz, then 44.1k or 48k is usually fine.
- The **Show Control Panel** button will jump to the system control panel for whatever audio device is selected.
- **Play Test Tone** helps you to troubleshoot audio issues by confirming whether sound can be heard through the correct device.
- Your connected MIDI devices will appear in the MIDI Devices area. Click the check box to accept MIDI from the device you want to use to trigger the instrument. In "All" mode, JUP-8 V4 listens for all MIDI channels so there's no need to specify a channel. You can specify more than one MIDI device at once.

1.3.2. Audio and MIDI settings: macOS

In an Apple Macintosh computer, the process is very similar to initial setup for Windows and the menu is accessed in the same way. The difference is that macOS uses CoreAudio to handle audio routing and the audio device selection is made in the second dropdown menu. Apart from that, the options work the same way as described in the Windows section.

In the upper left corner, click and scroll down to select **Audio Settings**.

This will bring up a pop-up window where you can assign the JUP-8 V4's sound to a valid audio output of your Mac.

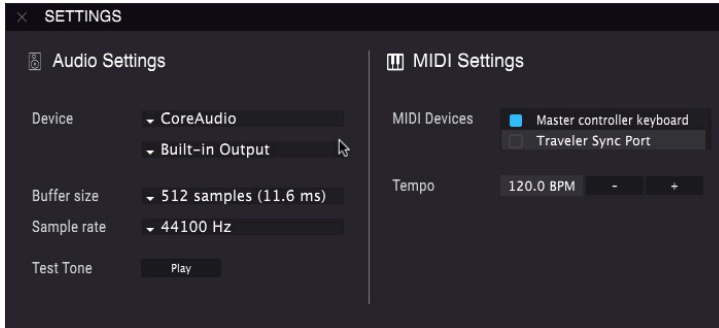

In this picture, we're using the Built-in Output of the Mac. Depending on what your audio interface is, you can assign it to any output that is available in the Apple utility [Audio MIDI Setup](#), available in the Finder at Applications/Utilities.

1.3.2.1. Tempo

When you're operating in standalone mode, this controls the master clock speed of all parameters whose SYNC button is on. For example, when the tempo here is set to 120 BPM (beats per minute), an LFO or the Arpeggiator whose Rate is set to 1/4 (quarter note) will synchronize to play 2 cycles or beats per second; if their Rate is set to 1/8 (eighth note) they will play 4 cycles/beats per second, and so on.

You can change the tempo by clicking on the Tempo field and typing a number, or by dragging from side to side.

1.3.3. Using JUP-8 V4 as an instrument plug-in in a DAW

JUP-8 V4 comes in VST, VST3, AU and AAX plug-in formats for use in all major DAW software such as Cubase, Logic, Pro Tools, Digital Performer, Garage Band and so on. You can load it as a plug-in instrument and its interface and settings work the same way as in standalone mode, with a few differences:

- The instrument will now synchronize to your DAW's host tempo/bpm rate, when tempo is a factor (e.g., when a parameter is in SYNC mode).
- You can automate numerous parameters using your DAW's automation system.
- You can use multiple instances of JUP-8 V4 in a DAW project. In standalone mode, only one instance is available.
- Any additional audio effects your DAW has available may be used to process the sound, including delay, chorus, filters, etc.
- You can route JUP-8 V4's audio outputs freely inside your DAW using the DAW's own audio routing system.

2. QUICK START: HOW TO PLAY JUP-8 V4 PRESETS

Now that all that computer stuff is out of the way, it's time to get familiar with your instrument. Assuming you want to hear the Jupiter as quickly as possible, this chapter is a shortcut to get you started without getting bogged down in details. A more complete explanation of the new Arturia Preset Browser is in [Chapter 10 \[p.79\] Preset Browser](#).

2.1. Sections of the visual interface

The layout of the JUP-8 V4 screen is very intuitive. There are six areas on the JUP-8 V4 window:

- the upper toolbar (small black strip at the top of the window)
- the Advanced Panel (which is hidden by default; see [Advanced mode \[p.13\]](#) in section 3.1)
- the Jupiter synthesis control area (the "top panel")
- the virtual keyboard area, which includes the MOD and BENDER wheels
- the lower toolbar (small black strip beneath the keyboard)
- the right sidebar (which is normally hidden, revealed by clicking on the sprocket icon in the upper right hand corner of the window).

We'll start with the upper toolbar since that's where you can start playing right away.



2.2. Preset selection tools in upper toolbar

The center of the upper toolbar of the JUP-8 V4 application window is where you'll find icons and data fields that give you quick access to presets (also known as *patches* or *programs*). The TYPE filter, preset number and name, and left / right arrows here give you easy access to the hundreds of presets in memory so you can get up and playing quickly without doing any programming.

i! Note that the "upper toolbar" we're talking about here is NOT the computer system's toolbar at the top of the computer screen which contains the standard application features like About, Preferences and Exit (PC) or Quit (Mac) commands.

The easiest way to audition the many sounds of the JUP-8 V4 is to click on one of the preset options in the upper toolbar:

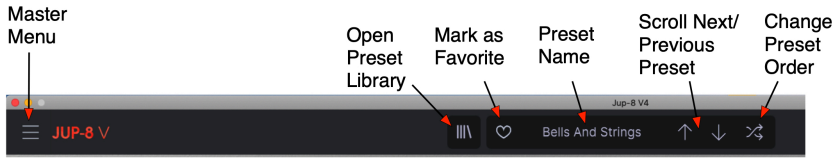

2.2.1. Scrolling through presets using the upper toolbar

Click on the **down arrow** in the upper toolbar to recall the next preset in the list.

Click on the **up arrow** to recall the previous preset in the list.

Click on the **Preset Name** field to display a list of different types of presets (or, ALL TYPES). Scroll down to the type you want, and another box will pop up with the presets of that type; scroll over to the one you want. The current type and preset is shown with a checkmark.

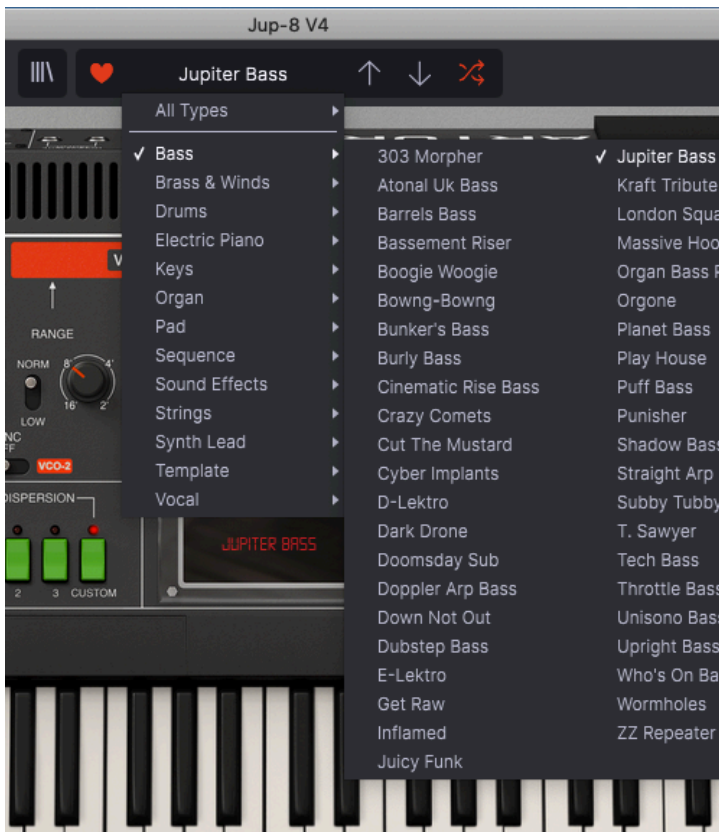

Now that you've chosen the Type, the up and down arrows will scroll only through the presets of that type. They will scroll in alphabetical order if the "random button" (the crossed arrows to the right of the down arrow) is off (gray) and in random order if the random button is on (red).

To display all the presets in memory again, select ALL TYPES.

You may be wondering at this point, how those types are assigned, and how to save your own patches. The answer lies in the...

2.2.2. Preset Library

On the left-center of the JUP-8 V4 top toolbar is an icon that looks like books on a shelf (III\). This is the icon for the Preset library and browser. Clicking on this brings up a SEARCH screen that occupies the whole window (except the upper and lower toolbars). This is a great place to search for exactly the right preset. Its features are explained in detail in [Chapter 10 \[p.79\]](#).

To return to the main screen, press the orange "X" at the same location where the Preset library icon was (upper toolbar to the right of the Main Menu).

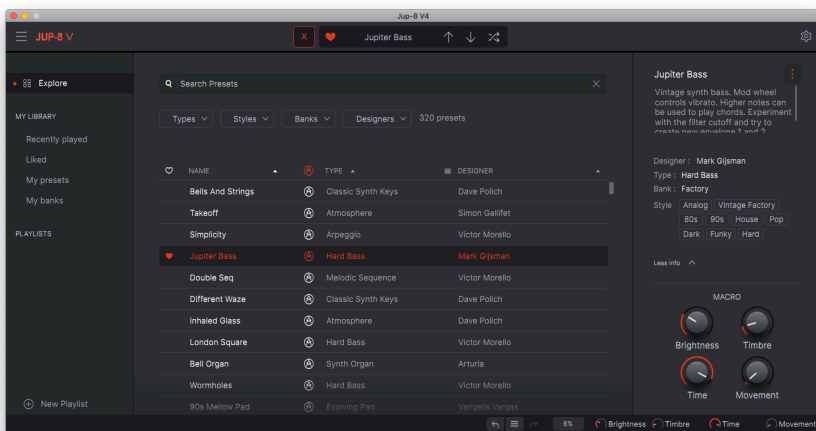

the Preset Library in SEARCH mode. Enter a word in the "Search Presets" box, or select one of the boxes below it to narrow the choices in the list

If you make changes to a preset, an asterisk (*) will appear after its name.

2.2.2.1. Scrolling Presets by Name, Favorite, Type, or Designer, or randomly

The default order is by Name of preset, in alphabetical order. The up/down arrows will scroll through the list as displayed. You can change the order of the list in several ways:

- Click on the heart icon to put your favorite presets at the top of the list.
- Click on the upward pointing triangle of the NAME column heading to reverse the alphabetical order (from Z to A).
- Click on the TYPE column header to sort the list by type (arpeggio>atmosphere>bass line, etc.)
- Click on the ≡ column header to select DESIGNER or BANK mode to sort by those.



This is only a brief explanation of the preset browser. For details see Chapter 10.

2.2.3. JUP-8 V4 menu [top left corner of app window]

In Chapter 1 [p.5], we already used this dropdown menu to access the Audio Settings for the JUP-8 V4. Most of the other commands in this menu involve presets and are already familiar to most users (Save, Save As, Import, Export). These functions are covered in detail in Chapter 10 [p.79] but deserve a quick look here.

2.2.3.1. Saving presets from the JUP-8 V4 Master Menu

The Master Menu contains a few shortcuts regarding presets:



Save Preset saves the current state of the JUP-8 V4 as a User patch with the current name. If you are editing a factory preset, you must first **Save Preset As...** using a different name. Names can be up to 32 characters long. If you want to start from scratch, select **New Preset...**

2.2.3.2. Import

Import is the command when you want to add a patch to your JUP-8 V4 library from outside your studio, or from an archive. You can import a single preset, an entire bank of presets, or a playlist. This command will bring up a popup directory window for your computer; simply navigate to a valid file (it **MUST** be in the .jup4x format) and click Open. This lets you share sounds between systems and with other users.

2.2.3.3. Export

When you want to share a preset you've made with someone else, or transfer patches to another computer, use the **Export** command and its submenus to export either a single preset or your whole User bank. This generates a .jup4x format file that may be uploaded, emailed, saved to a separate backup drive, etc.

2.2.3.4. Resize Window

To resize the JUP-8 V4 window to fit your screen: Click on **Resize Window**, which reveals another submenu, and select the size you want, from 50% to 200%. At 70%, the entire JUP-8 V4 app window can be seen on a typical 1440 x 900 laptop screen. On a smaller screen you may want to reduce the interface size so it doesn't dominate the display. On a larger screen or a second monitor you can increase the size to get a better view of the controls and graphics. The controls work the same at any zoom level but the smaller ones can be harder to see at the smaller zoom values.

See [Maximize View \[p.26\]](#) in the lower menubar section for another way to change the window zoom.

2.2.3.5. Tutorials

This feature guides you through the operation of the JUP-8 V4 step-by-step. It opens up the right sidebar's Tutorial tab, where you can select from several topics to learn about. **You may need to resize your window to see the right sidebar.** Anytime you need a refresher about the instrument, the basic explanations may be found here.

2.2.3.6. Help

The Help menu is where you have access to this user manual, and a link to a list of FAQs (Frequently Asked Questions) about the JUP-8 V4 on the Arturia website.

2.2.3.7. About

At the bottom of the upper-left JUP-8 V4 menu is **About**. Click on this to see a list of the extremely talented people who built this software for you, and to see what version of the software you have. Click anywhere on the JUP-8 V4 window to close the popup.

3. QUICK TOUR OF THE ARTURIA JUP-8 V4

Now that we've covered the basics of recalling presets, let us explain a few more basic toolbars and controls you need to know about, before we dive into the details of making your own sounds. When you're ready to learn more about these features, we suggest starting with [How Analog Synthesis Works \[p.28\]](#).

3.1. How to display the Advanced Panel

In the last chapter, we focused on the left side of the Upper Toolbar. Now let's look at the right side.

Arturia has added controls that weren't available in the original Roland Jupiter 8 that are normally hidden "under the hood" of the main panel to conserve screen space. These are covered in [a later chapter \[p.46\]](#) but you should be aware now that this panel exists. The Advanced Panel has four subpanels:

- **Modulations:** adding more modulation sources to the original instrument
- **Sequencer:** a 32-note step sequencer
- **Keyboard:** this is where you can route keyboard velocity, aftertouch, Mod Wheel, and tracking to various destinations for live control of the sound
- **Effects:** 3 digital multieffect modules that may be run in series or parallel

To show the Advanced Panel click on the word "Advanced" in the upper right corner of the upper toolbar, left of the symbol that looks like a gear.



To close the Advanced Panel and reduce the size of the JUP-8 V4 window, simply click the word "Advanced" again.

To select an Advanced subpanel:



Select any of the four subpanels by clicking on the one you want to see on the left side of the panel. In the screen shot above, the MODULATIONS panel is active and highlighted in red. All four Advanced modules are active, as shown by the red "on" switch in each section. You can click on any switch icon to turn off or bypass that subpanel without having to recall it to the screen.

More details on these features can be found in the [Advanced Panel \[p.46\]](#) section.

3.2. Right sidebar

To the right of the **Advanced** button in the upper toolbar is an icon for a gear or sprocket. Click on this to open the right sidebar, which contains settings that you may not need to change again after your initial setup.

i You may need to use the **Resize Window** command in the upper left menu to make the JUP-8 V4 window smaller so you can see the right sidebar on your screen. Or, if your computer keyboard has an additional number keypad on the right side, hold CMD and press the "-" key in the number keypad (NOT the "=" key above the letter keys) to resize the window.

There are four tabs or subpanels to the right sidebar: Settings, MIDI, Macro, and Tutorials. We've already covered [Tutorials](#), so let's cover the rest.



the right sidebar with the MIDI tab selected. It is showing a list of the MIDI Continuous Controllers (CC) that are currently mapped to controls on the top panel. Note that the ADSR faders for the filters are tinted RED, showing that they have been mapped. Other controls are tinted in PURPLE; they may be clicked on and assigned to a CC if desired

3.2.1. Settings

3.2.1.1. Global Settings: MIDI Channel

This data field determines which MIDI channel(s) the JUP-8 V4 will "listen" to. The default is All (e.g., Omni mode). In this mode, any MIDI messages on any MIDI channel will play the sounds of the JUP-8 V4. To set the JUP-8 V4 to respond to its own individual channel, choose a value from 1 to 16.

Open this tab to set the MIDI channel (1-16, or ALL) that the JUP-8 V4 will respond to.

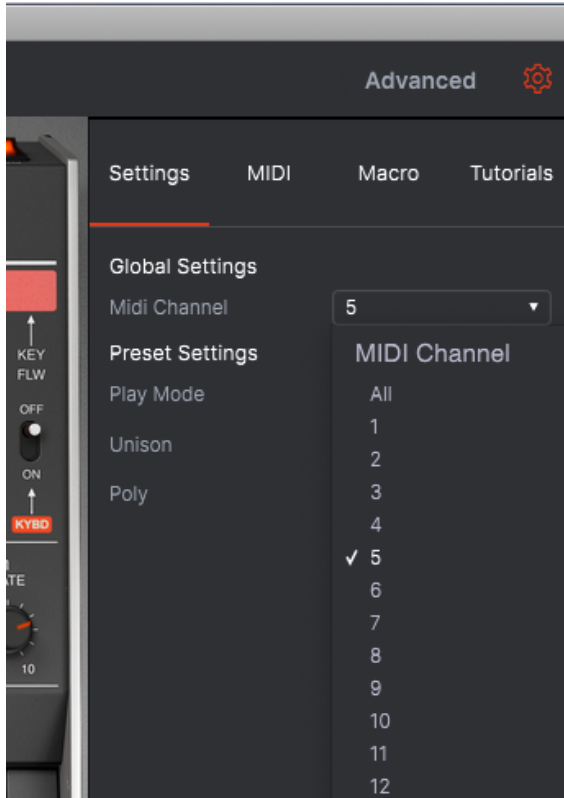

3.2.1.2. Preset Settings: Play Mode and Unison

These fields, in conjunction with the VOICE ASSIGN keys on the top panel, determine the voice allocation of the JUP-8 V4. They are described below in [Voice Assign \[p.24\]](#). Fields are greyed out depending on the current voice mode: Solo, Uni, or Poly. Play mode is available only in Solo and Uni, Unison is available only in Uni mode. In either Poly mode, only the Poly pulldown window is available.

3.2.1.3. Poly [Polyphony control]

JUP-8 V4 allows a maximum polyphony (voices that can be playing at the same time) of 16 voices. A higher voice count is also more CPU-intensive, so this menu gives you the option to limit the number of voices to ease the workload on your computer. This setting is stored independently with each preset, so you can limit one preset to 4 voices and another to 16, depending on the needs of the preset.

To change the number of available voices, put VOICE ASSIGN into either of the POLY modes, click on the **Poly** field in right sidebar's Settings tab and scroll to your selection. You can set the polyphony from Mono to 16 voices. A check mark indicates the currently selected Poly setting.

This setting has no effect when the VOICE ASSIGN mode is set to SOLO or UNI.

3.2.2. MIDI Controllers

This tab lets you select your MIDI controller, either a generic MIDI controller, or you can select one of Arturia's keyboards to exploit its special features.

But the main function here is to let you set up almost any parameter of the JUP-8 V4 to be controlled in real time from a MIDI source, either hardware or software. The MIDI tab of the right sidebar displays a list of all of the JUP-8 V4's controls that are already mapped to MIDI continuous controller (CC) commands (see the illustration at the head of this section). All controls on the top panel that are highlighted in RED have been assigned to CCs already; if you click on one, its CC will be highlighted in the list. You can edit the Minimum and Maximum values you want each control to have (though they can't be outside the limits of that control, for example an envelope decay can't be longer than 46500 ms, but it can be shorter).

To map an additional parameter to a CC:

All unassigned controls, on the top panel or in the Advanced panel, that are highlighted in **purple** on the screen, can be mapped to a CC.

Click on any control (fader, knob or switch icon), then send the CC message you want this parameter to be controlled by from your hardware (or DAW sequencer) to the JUP-8 V4. The controller will be automatically linked to the destination parameter, and the control image will turn red.

- **You won't be able to modify any settings as long as you're in this mode.** Click any other tab of the right sidebar, or close the right sidebar to leave this mode.
- To save your configuration, click on the dropdown menu next to **MIDI Config**. This lets you save, delete, import, export and recall different MIDI CC setups. For example, you may have one configuration for playing live, and another for playing in the studio. The Default and Empty sets cannot be deleted.

3.2.3. Macro

This tab of the right sidebar is where you assign the four Macro knobs on the lower right corner of the window to specific destinations of the JUP-8 V4.

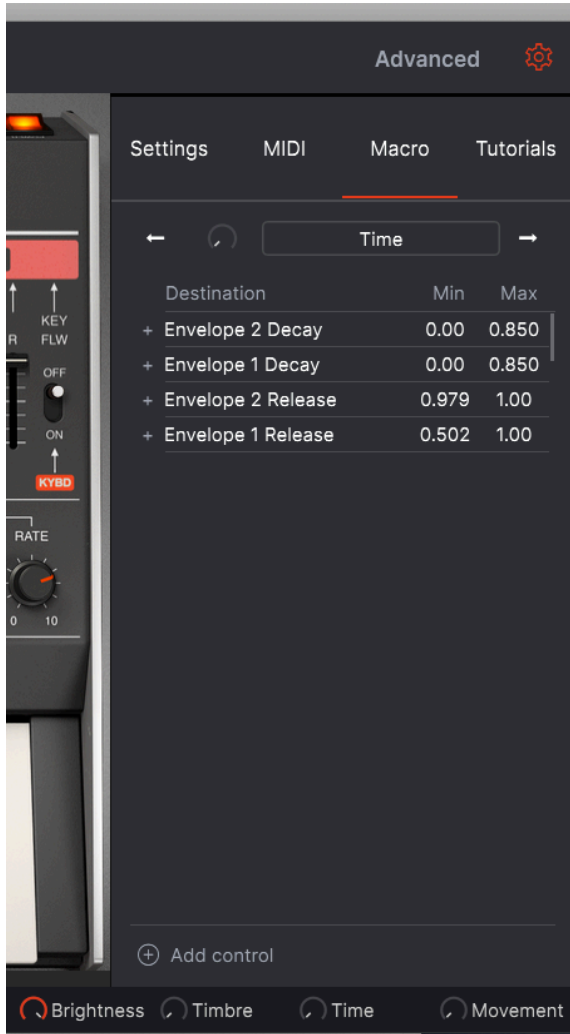

There are four macro controls. They allow you to control several parameters at once by turning a single knob. Their default names are Brightness, Timbre, Time, and Movement, but you can rename them as needed. In the illustration above, the **Time** macro will increase the decay and release times of both envelopes at once.

Macros are saved for each preset. In most factory presets, Brightness is mapped to a VCF Cut, Timbre is mapped to VCF Resonance or Pulse Width, Time is mapped to Envelope times, and Movement is mapped to modulations (LFO, chorus depth, etc.). But any time you want to associate several controls and make them work together, a Macro is the way to go.

To see the current assignments of each Macro, click the left or right arrows to cycle among the four macros.

To add a control to a Macro, click the [+ Add control](#) at the bottom of the window. Then click on any fader, knob or switch in the display that is marked in purple. Set the range you want by clicking and dragging in the [Min](#) and [Max](#) fields, or by typing a number in them.

To rename a Macro, simply click in the name field and type.

To change the curve of a Macro destination, click on the "+" sign next to the Destination name. Click any point on the line to make a custom curve:



This allows you to adjust independently how much the Macro affects each parameter at each position of the knob.

3.3. Top panel general controls

Some important controls are on the top panel above the virtual keyboard:



3.3.1. Volume

The rotary control on the lower left side of the control panel is the master volume control for the JUP-8 V4. Click and drag the knob to select a value within the range of +0 to -60 decibels (dB). Double-click the knob to reset the volume to its default value of -15.0 dB. The VOLUME is saved with each patch. This parameter will also respond to incoming MIDI CC #7 (MIDI volume) messages by default.

3.3.2. Master Tune

Click and drag on this control to adjust the tuning of the JUP-8 V4 to match other instruments if necessary. At the 12 o'clock position, zero, it is in standard concert pitch (A440). At full clockwise the tuning is A480, at full counterclockwise it is A400.

Double-click on the control to set it back to standard concert pitch (A=440 Hz).

3.3.3. Unison Detune

The JUP-8 V4 has the ability to stack multiple voices onto a single note to fatten the sound when the VOICE MODE is in UNI mode. The UNISON DETUNE knob determines how much the additional copies of the sound will be detuned from each other to make a fatter sound, like voice doubling. You'll hear the characteristic sound of two slightly out-of-tune notes beating against each other. Low settings sound a bit like flanging, higher settings like fast chorusing...in fact, this detuning is exactly what a digital chorus effect was designed to emulate.

Double-click the UNISON DETUNE knob to set it to its default value of 0.125, or 1/8th of a semitone. At the maximum setting (full clockwise), the voices may be as much as 1/2 a semitone (50 cents) out of tune with each other. The more notes held on the keyboard at a time, the fewer available unused voices there will be to stack and detune, so the detuning effect diminishes.

UNISON DETUNE has no effect except in UNI mode, and has no effect if the **Unison** field in Setting of the right sidebar set to 1. See [VOICE ASSIGN \[p.24\]](#) and [SOLO \[p.24\]](#) for more detail.

3.3.4. Pan Spread

This controls how much width there is in the stereo output of the JUP-8 V4. When fully counter-clockwise (O) the signal is centered (mono); when fully clockwise (10) the stereo spread is at its widest. In Poly mode, the first note played is centered, the second hard left, the third hard right, the fourth half left, etc. In Unison Classic mode, the voices are spread across the stereo field in fixed values so that there is a good balance no matter how many notes you play.

3.3.5. Portamento

The PORTAMENTO control sets the amount of time it takes to go from one pitch to another. When it's set to zero or the switch is OFF, there is no glide time between notes. As you increase the portamento time, it will take longer and longer to glide from one note to the next, to a maximum of 3500 milliseconds (3.5 seconds) between pitches. Portamento effects were used often by musicians such as Keith Emerson and Rick Wakeman.

3.4. Virtual keyboard area

The virtual keyboard occupies the lower section of the JUP-8 V4 window. This is a visual display of a typical piano keyboard that allows you to play and modify sounds without the need to connect an external MIDI hardware controller. You can click and drag on controllers to change them, and click on a switch or indicator to turn it on and off.

3.4.1. The virtual keyboard

The virtual keyboard is always available. It makes it easy to audition sounds while you're programming without taking your hands away from the computer. Simply click on a virtual key to hear the currently selected sound. You can also drag the cursor across the keys to hear a glissando.

Velocity: Clicking near the front edge of the key results in a higher velocity note; clicking near the back of the key produces a soft velocity.

 To use velocity in a program, go to the Advanced Panel, select the Keyboard subpanel, and assign Velocity to the destination *VCA Env 2 Amt*. Velocity is also available as a Mod Source in the Modulations subpanel. Assigning Velocity to *VCA Env 2 Amt* or to a parameter like VCF Cutoff or an Env Sustain level will change the sound depending on how hard you play the keyboard.

When the JUP-8 V4 is in standalone mode, you can also play notes by clicking on the JUP-8 V4 window and typing on your computer's alphanumeric keyboard. The letters on the center "home" row of the alphanumeric keyboard correspond to the C Major scale, sharps and flats are on the row above it, as in this table:

Letter	A	W	S	E	D	F	T	G	Y	H	U	J	K	O	L
Note	C	C#	D	Eb	E	F	F#	G	Ab	A	Bb	B	C	C#	D

To shift the QWERTY playing range up an octave: Press the letter "X" **To shift the QWERTY playing range down an octave:** Press the letter "Z"

If you have an AZERTY keyboard, the layout goes like this:

Letter	Q	Z	S	E	D	F	T	G	Y	H	U	J	K	O	L
Note	C	C#	D	Eb	E	F	F#	G	Ab	A	Bb	B	C	C#	D

To shift the AZERTY playing range up an octave: Press the letter "X"

To shift the AZERTY playing range down an octave: Press the letter "W."

3.4.2. Parameter help and value popups



When you hover the cursor over a control, its name and description will appear in this lower left-hand corner of the window. The current value of a control will also appear in a text balloon next to your cursor.

3.4.3. Bender

Click on this wheel and drag to the right to bend the pitch up, or to the left to bend the pitch down IF the VCO BEND fader is not at zero and the VCO-1 and/or VCO-2 switches are ON. The Bender "snaps back" to the center position (back to normal) when it is released. The VCF can also respond to the bender if its switch is on and the fader is up (providing something else hasn't already opened the VCF to its maximum already).

3.4.4. Modulation Wheel (LFO MOD)

The MOD wheel is a live performance control that takes the signal from the top panel's LFO (Low Frequency Oscillator, LFO 1) and can send it to both VCOs and the VCF via the switches and faders to its left. Typically, you'll use it to dynamically add vibrato to certain notes of a solo. Like the pitch bender below it, you can click and drag on the mod wheel to move it. Unlike the pitch wheel, the mod wheel will stay in its current location until it's moved. Its MIDI CC (continuous controller) number is O1.

i If you want to use the MOD wheel to control something besides the VCO and VCF, it appears as a source in the Advanced Panel's Modulation Mixer as "ModWheel".

i The MOD wheel is intended as a performance control, that is, something that you increase or decrease in real time for musical expression. If you'd like the LFO to affect the sound all the time (for vibrato or tremolo, for example) use the **VCO MODULATOR** and **MOD** faders on the top panel.

3.4.4.1. LFO MOD VCO and VCF switches and faders

These allow you to control the range of the MOD wheel's effect on the pitch or timbre of the sound.

- To send the LFO to the VCOs, the switch must be in the ON position and the fader must be up. At its highest setting, the vibrato will span two octaves when MOD is all the way up.
- To send the LFO to the VCF, same story. (But a reminder that to get a "wah-wah" effect, the VCF CUT has to be down, and the VCF can't already be opened by an envelope or some other mod source.)

The LFO MOD switch and fader positions are saved with each preset.

3.4.5. Arpeggiator

An arpeggiator allows you to hold down one or more keys and hear those notes automatically played back at a fixed tempo, one after the other. Many great pieces of music have arpeggios at their core, from Bach's Prelude 1 in C Major to Eddie Van Halen's hammer-on segment in Eruption. Instead of having to play notes over and over with your fingers, you can hold notes down and the arpeggiator will play them for you. An arpeggio is typically a series of notes outlining a chord; when you hold multiple keys down at the same time on the keyboard, instead of hearing a chord, you'll hear each note of the chord played in sequence according to the MODE that you select, at a tempo selected by the RATE.



In some ways an arpeggiator is more improvisational than a step sequencer, because you can decide on the spur of the moment to change which notes the arpeggio will produce by changing which notes you are holding, and how many. If only one note is held it will be repeated; when two or more notes are held the arpeggiator will alternate between the notes, when more notes are held the arpeggiator will alternate between them. The creative possibilities are endless. Octave jumps can still be defined and randomized, so the arpeggios can be as crazy as you want them to be.

To turn on the Arpeggiator, click the ON switch. As you hold a note or notes on the keyboard, it will arpeggiate according to the current RANGE and MODE, at the speed selected by the RATE control on the right (if the switch is in) or in **SYNC** with your sequence (either internal or from your digital workstation).



Press the **HOLD** button to keep the pattern going even after you let go of the keys. During an arpeggio, the voice allocation is cycled, so if **DISPERSION** values are greater than zero, each pass of the arpeggio will sound a slightly different version of each note, as would happen in an analog circuit.

3.4.5.1. Rate and Hz/Sync switch

These two controls determine the speed of the arpeggio. When the switch is in the **Hz** position, as shown above, the rate is adjustable from 0.1 to 50 Hz. When the switch is in the **SYNC** position, the rate is adjustable from 1/2 to 1/64th of the current tempo, with 1/4 equaling one beat. The tempo is set externally by the computer either in the Audio MIDI Settings or incoming MIDI clock, or, when run as an instrument plugin, by the DAW's tempo setting.

3.4.5.2. Range

These four orange switches select the range of the arpeggiator in octaves. When 1 is selected, the arpeggiator will play just the notes in the keyboard range you're playing. When 2 is selected, it will play those notes, then repeat them an octave higher before restarting the cycle. Octaves 3 and 4 do the same thing: play the notes of the Mode through a 3 or 4 octave range.

For example, if the range is set to 3 and you hold down a low "C" on the keyboard, it will play low C-middle C-high C automatically.

- Range 1: One octave
- Range 2: Two octaves
- Range 3: Three octaves
- Range 4: Four octaves

3.4.5.3. Mode

These seven red switches determine the pattern that the arpeggiator will play when you hold down keys on the keyboard.

From top to bottom the options are:

Mode	Description
UP	Notes are played back in ascending order from lowest to highest. New notes are inserted into the arpeggio as they are played.
DWN	Notes are played back in descending order from highest to lowest. New notes are inserted into the arpeggio as they are played.
ORD	Held notes will be arpeggiated in the same order they were played.
REV	Held notes will be arpeggiated in the reverse order they were played.
INC	Held notes are played back 'up and down' in ascending order and then descending order, repeating the highest and lowest notes before the direction is reversed.
EXC	Held notes are played back 'up and down' in ascending order and then descending order. The highest and lowest notes are triggered only once and then the direction is reversed.
RND	Random: notes are played back in random order.

3.4.6. VOICE ASSIGN

These switches change the voice allocation style of the JUP-8 V4. The JUP-8 V4 has up to 16-note polyphony in either POLY mode. The first generations of analog synthesizers were monophonic: they could play only one note at a time, and there are times when that style is called for. The VOICE ASSIGN buttons let you select how you want to use the voices as follows:

3.4.6.1. SOLO

Press SOLO to play single-note solos that recreate the classic synthesizer solo sounds; there is no polyphony in SOLO mode, it becomes a monophonic instrument. When SOLO is lit, the **Play Mode in the Settings tab of the right toolbar** becomes active, determining the note priority, i.e., what happens when you press down more than one key on the keyboard at a time:

- Low: play only the lowest note
- High: play only the highest note
- Last: play whatever note was last pressed.

3.4.6.2. UNI [Unison]

UNI mode is as mode of voice allocation where voices are assigned and "stacked" onto whatever keys of the keyboard are currently pressed; and the voices may be slightly detuned from each other using the UNISON DETUNE knob above the MOD wheel. The result is a rich harmonic sound, similar to a chorus effect. There are two basic UNI modes, set in the Unison field of the right toolbar: **Unison Classic**, and **Unison 1-8**.

When it is set to Classic, you can play chords. The patch is still polyphonic; the more notes that are held, the fewer voices are available to "stack" on each one and the less detune effect there will be.

In any other Unison mode beside Classic, the JUP-8 V4 is monophonic, just like SOLO mode. It follows the same Play Mode as SOLO does. In fact, when set to a value of 1, it will sound the same as if VOICE ASSIGN were set to SOLO. To fatten the sound in UNI mode, you can stack up to eight voices onto the key being played by setting the Unison field in Settings of the right toolbar to a value between 2 and 8. In this mode, each voice can be slightly detuned from the others using the [UNISON DETUNE \[p.19\]](#) control. The stacked voices are panned across the stereo field as well, with width determined by the PAN SPREAD control.

3.4.6.3. POLY 1 [Classic Reassign]

This is the most natural polyphonic playing mode, with one voice assigned per key until maximum polyphony (set in the bottom toolbar) is reached, at which point the oldest note will be "stolen".

3.4.6.4. POLY 2 [Reset]

In this polyphonic playing mode, a note played cuts the release of the previous note played and released. The difference is most noticeable when envelopes have long release times. For example, with a long release if you play a C3, release it, then play a E3, the release of C3 is cut instantly. This leads to less clutter when playing notes and chords with long release times.

The total polyphony in either POLY mode is set in the right toolbar's **Settings** menu. In both Poly modes, if the next note played is the same as the previous note, it will keep using the same voice, starting the attack from the current level of the release time of the envelope,

3.4.7. HOLD

When HOLD is on, the effect is similar to a sustain pedal: when you remove your hands from the keyboard, the envelopes will advance through their Attack, Decay, and Sustain stages as if you were still holding down notes. Provided there is a Sustain level in the envelopes, the note will play indefinitely until you turn HOLD off. If the Arpeggio is on, it will keep playing the arpeggio.

3.4.8. Bottom toolbar

At the very bottom of the JUP-8 V4 window, underneath the virtual keyboard, is the bottom toolbar covering various MIDI features, great features we want to make sure you don't miss. [Earlier \[p.21\]](#) we covered the parameter name display on the far left of the toolbar, but now let's explore the parameters towards the right side of the bottom toolbar:

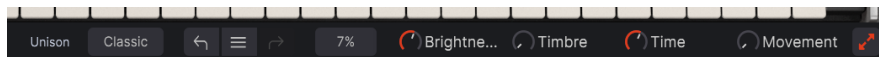

i: If you can't see the bottom toolbar, you may need to scroll down to the bottom of the window, or use the [Resize Window \[p.12\]](#) menu to reduce the window size.

3.4.8.1. Unison voice setting

This field will only display IF the UNI switch is on in the VOICE ASSIGN section. It is a duplicate of the display in the right sidebar's Setting tab. A setting of *Classic* stacks voices with polyphony, and a setting from 2-8 makes the preset monophonic with multiple voices stacked on each single note.

3.4.8.2. Undo, Undo History, and Redo

Whenever you make a change to a setting, it is recorded in the Undo History and the Undo arrow (pointing to the left) becomes active. If you don't like the last change you made, click the Undo arrow to return it to its previous setting. Change your mind and want to "undo the undo"? Click on the right arrow, which is now active, and click on that. You can click on the Undo History (the three bars that look like a hamburger between the two arrows) to see what changes you've made, and select an earlier point in history to go back to.



3.4.8.3. Percentage CPU display

The percentage display right side of the bottom toolbar is a gauge of how hard your computer's processor is working at the moment. If you're running many different instrument plug-ins at the same time, or doing complicated tasks with other programs, the central processing unit (CPU) of your computer may reach the limits of its power.

To lessen the load on your computer, you can reduce the JP-8 V4's polyphony, or disable some effects. However, the JUP-8 V4 isn't a likely source of processor overload by itself.

i: If you run into a situation with stuck notes, or other problems that don't respond to any top panel controls, click on this display. This essentially sends an 'all notes off' message to the JP-8 V.

3.4.8.4. Maximize View

If you use the Resize Window control to magnify the JP-8 V's display and some of its parameters are pushed outside the viewable range of your display, you might see a couple of orange arrows show up on the far right corner of the bottom tool bar.

This is the Maximize View button. What it does is provide a quick way to resize the window without having to use the pull-down Resize Window menu in the upper left corner. When you click this button, JUP-8 V4 will make the most of the available screen space by re-centering the JUP-8 V4 window and expanding it downward toward the bottom of your display.

But if you still can't see everything at the same time then you may want to select a smaller magnification value using the [Resize Window \[p.12\]](#) feature in the JUP-8 V4 menu. Naturally there's a balance to be struck: Resizing the JUP-8 V4 window can prevent the need to scroll the window up and down, but it also makes it more difficult to read some of the smaller text.

Well, that's it. We've explained everything you need to know about the Arturia JUP-8 V4, if you're only going to play the library of preset sounds. That's perfectly fine. You can ignore the dozens of other controls if you want. Really, you don't need to know what a VCO or a VCF is. Just don't touch anything else.

We're kidding! Now we'll explain all those other, more interesting switches and knobs on the top panel in the next chapters.

4. HOW ANALOG SYNTHESIS WORKS

If you've never programmed an analog synthesizer before, here's a basic explanation of how the different controls of the Jupiter 8 relate to each other. It may seem complicated at first glance, but actually the controls on the top panel are arranged in a very logical way. Once you understand these basic concepts you'll be able to make your own sounds on almost any analog synthesizer, since most classic analog synthesizers use a similar structure.

4.1. What each module does

4.1.1. VCO

Stands for *voltage-controlled oscillator*. This is the fundamental sound source of analog synthesis. Each VCO generates an audio signal based on a DC voltage from the keyboard, combined with modulation sources; the higher the voltage, the higher the pitch. That voltage and pitch can be changed not only by the keyboard, but from envelopes, low frequency oscillators (LFOs), even another VCO.

In the Jupiter 8, each voice has two VCOs (VCO-1 and VCO-2). Since it has up to 16-note polyphony, there are actually 32 VCOs in the instrument. Part of the unique sound of the Jupiter is its ability to stack all those VCOs onto whatever keys you're pressing. See [Unison Detune \[p.19\]](#) for details.

In analog synthesis, it's important to realize that a VCO is always "on", generating signal, like a test tone in a laboratory. (Press the HOLD button to see this "infinite sustain" characteristic.) To be musically useful, the audio from the VCO has to flow through other modules (in the Jupiter, a VCF and VCA) that will "shut it off" (sooner or later) when you take your fingers off the keyboard.

4.1.2. VCF

Stands for *Voltage-Controlled Filter*: If VCOs are the heart of analog synthesis, VCFs are its soul. A VCF is a powerful and dynamic tone control that can sweep across the frequency spectrum in response to your playing, or simply act as a static lowpass filter cutting the upper frequencies of the signal passing through it.

The VCF in the Jupiter 8 is a *resonant low-pass filter (LPF)* with a sweepable frequency control. The CUT control, plus modulations, determines the cutoff frequency. Only sounds below this cutoff frequency will pass through; everything above it will be filtered out at a slope of either -12 dB or -24 dB per octave. At its lowest setting, (20 Hz), virtually no audio will pass through the VCF. **If the VCF CUT, MOD, and KEY FLW controls are at zero, no sound will come out of the Jupiter-8. Even if the MOD control is up, if the Envelope settings are down, it still will filter out all the signal.**

4.1.3. VCA

Stands for *Voltage-Controlled Amplifier*. The signal passes through this after the filter section; controls the final output level over time. It's the last step in the signal path. The VCA "opens and shuts the door" on the signal based on how the ADSR controls of ENV-2 are set.

If the VCA LVL control is at zero, or if ENV-2 controls (A, D, S) are all at zero, no sound will come out of the Jupiter-8.

In analog synthesizers, a DC voltage from an envelope generator (or other source) "opens up" the VCA: at 5 volts the VCA is wide open, as the voltage falls lower, the volume output of the amp is also lowered, until at 0 volts it is closed and no signal passes through the VCA at all.

Don't be misled by the word "amplifier" here: it doesn't make the signal louder, it is a negative amplifier with the ability to reduce the signal level below unity gain.

The JUP-8 V4 main panel consists of:

- 2 oscillators (" VCO 1 and 2 ") in which the second can equally be used as a source of modulation
- 1 mixer to set the balance between the 2 oscillators
- 1 High pass filter (" HPF ") 6dB/oct non-resonant
- 1 low pass resonant filter (" VCF ") 12/24dB/oct
- 1 amplifier ("VCA")
- 2 envelopes dedicated to filter and amplitude modulations
- 1 LFO (low frequency oscillator)
- a MOD wheel section (LFO MOD) dedicated to the LFO in performance

4.2. Audio and modulation signal paths

The middle section of the top panel is laid out from left to right in order of the actual signal path:

- a pair of oscillators (VCOs) generate the audio signal with a fixed set of harmonic overtones (such as a square wave, sawtooth wave etc.),
- filters (HPF and VCF) change the tone of the sound,
- and the amplifier (VCA) changes the volume/level of the sound.

The left and right sections of the top panel contain the modulators: the Low Frequency Oscillator (LFO) and VCO Modulator on the left, and the Envelopes (ENV-1 and 2) on the right. These sections don't make any sound on their own (usually), but are designed to be "plugged in" to the signal path to change the sound over time:

- When sent to a VCO, they change its pitch (LFO for vibrato, ENV for pitch sweep)
- When sent to the VCF, they change the timbre (like a wah-wah or horn mute)
- When sent to the VCA, they change the amplitude level (LFO for tremolo, ENV to provide the way the sound attacks and decays over time).

Below is a simplified flow chart of how this all fits together “under the hood” of the JUP-8 V4.

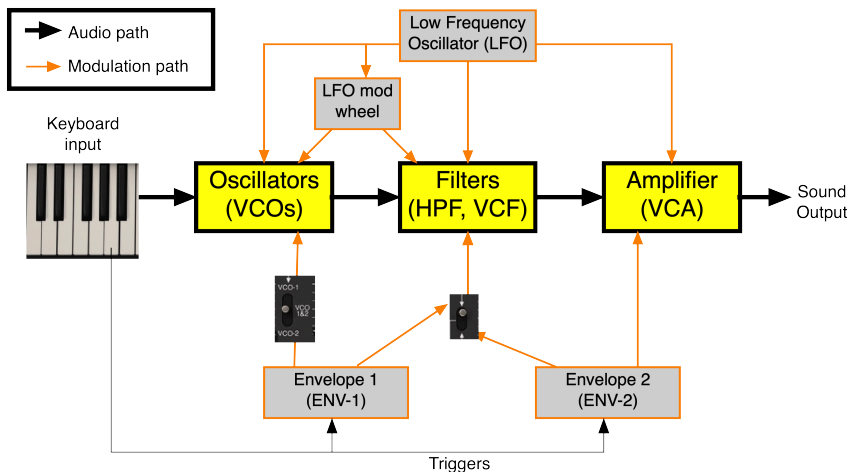

4.3. VCOs generate the sound

When you press a key or keys, it tells the oscillators what basic pitches or notes to generate; it also sends a *trigger* to the envelopes telling them to start their attack. The basic pitch of each VCO can be modulated, if you want, by the LFO directly, or by the LFO when you increase the MOD wheel (notice the two orange arrows pointing at the top of the VCOs). The pitch can also be affected by ENV-1; a three-position switch determines whether VCO-1, VCO-2, or both oscillators will be modulated

The output of the VCOs, after passing through a mixing knob that lets you set the balance between VCO-1 and VCO-2, now proceeds to the HPF (High Pass Filter) that cuts the bass out of the signal if desired. Unlike the VCF, the HPF can't shut the audio off completely.



The HPF frequency can't be modulated by the LFO or envelopes unless you're using the Modulations section of the Advanced Panel...more on that later.

4.4. VCF [Voltage Controlled Filter] filters the sound

Next comes the VCF, where the real fun begins. The VCF has the power to “open or shut” the low-pass filter, depending on the settings of the VCF’s CUT Control and the input from either ENV-1 or ENV-2 as selected by the 2-position switch between them. Like the Oscillators, the VCF can receive LFO modulation either directly, or via the MOD wheel.

4.4.1. The difference between HPF CUT and VCF CUT

The most common misunderstanding of the filter section of the Jupiter 8 involves the two CUT faders that are right next to each other:

- When the HPF CUT fader is all the way down, the filter is wide open and is essentially bypassed.
- The VCF CUT control is the opposite: it’s wide open when its fader is all the way up.

This apparent contradiction is because the two CUT controls are not “level controls”, they are crossover frequency controls. When VCF CUT is at the bottom, it rolls off all frequencies above 20 Hz...which shuts the audio path down entirely (unless one of the modulators opens the filter).

Which leads to another common question from first-time programmers: “How come the VCF MOD control doesn’t seem to affect the sound at all? How can I get that filter sweep sound?” The answer is simple: When the VCF CUT control is at maximum, the filter is almost wide open, so opening it further with modulation has very little effect. **Lower the VCF CUT fader until you hear the effect you want.**

4.4.2. Envelope choice and Resonance [RES]

The switch between the envelopes and the VCF lets you select which envelope controls the filter. In the ENV-1 position, the VCF can follow a different curve from the VCA; in the ENV-2 position, the VCF follows the same envelope that controls the VCA.

The RES control of the VCF stands for Resonance. A resonant filter has a “peak” or resonance that emphasizes the frequency at the pass point; at a high resonance, it is so close to feeding back that it is like another tone generator. (In some synths, the resonance can go into total feedback and generate a sine wave; the Jupiter stops short of that point.)

4.5. VCA [Voltage-Controlled Amplifier] controls the amplitude of the sound over time

The last stage in the audio path is the VCA, which is usually triggered to open and close by ENV-2. The VCA’s default setting is off. If it’s not opened by a modulator (either ENV-2 LVL or LFO MOD), no audio signal will pass through to the output.

4.6. Summary

That's the basic flow of signal within the JUP-8 V4. As long as you keep these concepts in mind, you'll be able to craft a sound that's right for your project:

- The oscillator modules generate the basic sound; everything after that in the chain is dependent upon the sound they originate.
- The filters have the ability to take away or filter certain parts of the audio spectrum generated by the oscillators. The VCF will also stop the signal in its tracks entirely when it is closed.
- The VCA, under control of ENV-2, determines the final time contour of the signal output: how fast it fades or jumps in, how long the initial "hit" lasts, how loud it will be when you hold the key, and how fast it will fade away after you release the key.
- Modulators don't make sound; they are inputs that affect the pitch, filter, and level of the sound in the audio path.

The next chapters cover these sections in detail.

5. VCOS

The top-panel modules VCO-1 and VCO-2 make up the oscillator section of JUP-8 V4. This is where the sound starts. Here, you select the waveforms for each VCO, set their pitch, what modulates their pitch (if anything), and how the two VCOS interact with each other.

5.1. VCOS 1 and 2

There are two oscillators to each voice. When the VOICE MODE is set to 16-note polyphony, that's a total of 32 oscillators that may sound at one time. Each oscillator has its own tuning control and can select from one of four different waveforms. By tuning them to various frequencies, or by mixing different waveforms, the two oscillators allow you to quickly obtain a rich variety of sounds simply by altering the top panel knobs, switches, and faders.

5.1.1. Differences between the oscillators

As tone generators, both VCOS perform similar functions, but you should be aware of some differences in their capabilities:

- VCO-1 is typically the "root" of the sound because its pitch can be set only to the note being played or one of its octaves: its RANGE switch has only 4 positions.
- VCO-2 is typically used as a harmonic of the sound, because it can be set to any interval above or below the root note: its RANGE switch has 32 positions. It can be fine-tuned plus or minus a semitone as well.
- Both oscillators can generate sawtooth and rectangle waves. In addition, VCO-1 can generate a triangle wave or a square wave, and VCO-2 can generate a sine wave or white noise.
- VCO-2 has a LOW setting that allows it to be used as an additional Low Frequency Oscillator.
- VCO-1 has a CROSS fader that lets its frequency be modulated by VCO-2, either as an LFO or cross modulator drastically affecting the sound spectra created by VCO-1.

5.2. Source Mix control

The balance between the two VCOS is set by the SOURCE MIX knob in the center of the top panel.

- **To hear only VCO-1:** Turn SOURCE MIX full counterclockwise (LEFT)
- **To hear only VCO-2:** Turn SOURCE MIX full clockwise (RIGHT)
- **To hear both VCOS equally:** Double-click on SOURCE MIX (CENTERED)

Any setting in-between will increase one, and decrease the other as desired.

5.3. VCO-1 Controls

- **RANGE:** Sets the frequency of VCO-1 to one of four octaves 16', 8', 4', 2'. (The octaves are indicated in feet, referring to the length of the pipes of pipe organs; a 4-foot pipe sounds an octave higher than an 8-foot pipe). Double-click the control to set it to the default of 8' (middle C = middle C).
- **WAVE:** Sets the oscillator to generate one of four waveforms:
 - Triangle
 - Saw Tooth
 - Rectangle or Pulse (the pulse width of this waveform is set by the PWM fader)
 - Square
- **CROSS:** This fader sends the signal of VCO-2 "across" to cross-modulate VCO-1. When VCO-2 is in LOW mode, it causes subsonic frequency modulation (vibrato); in NORM mode, it causes audio rate frequency modulation. See [CROSS \[p.38\]](#).

5.4. VCO-2 Controls

- **RANGE:** Adjusts the frequency range for VCO-2 continuously in semitones from -12 (marked as the 16' setting) to +24 (marked as the 2' setting). For example, if RANGE is set to 7 semitones, when VCO-1 is sounding a middle C, VCO-2 will sound a middle G.
- **NORM/LOW switch:** In the NORM position, VCO-2 generates audible frequencies according to the keys being played. In the LOW position, it becomes a low-frequency oscillator that does not respond to the keyboard, so you can use it as an LFO to modulate the frequency of VCO-1.
- **FINE TUNE:** Knob to fine tune VCO-2's pitch in a range of plus or minus one semitone.
- **WAVE:** Sets VCO-2 to generate one of four waveforms:
 - Sine
 - Saw Tooth
 - Rectangle or Pulse (the pulse width of this waveform is set by the PWM fader)
 - Noise (White noise in NORM, Pink noise in LOW)

5.4.1. Noise waveform

The noise waveform adds an interesting complement to the sonic possibilities. It is very useful to create breath effects (flute tones for example) or special effects like the sound of wind. Unlike all other waveforms, this is a fixed generator; it doesn't change its output no matter what key is played or what the RANGE setting is.

It IS affected by the NORM/LOW switch. In the NORM position, it generates white noise, which has lots of high-end "hiss" because it adds all frequencies in the audible spectrum together, and there are more high frequencies than low frequencies. In the LOW position, it generates pink noise, which is more of a "roaring jet" sound because it has equal energy in every octave of the spectrum.

5.5. About waveforms

Each kind of waveform has its own unique harmonic content. Understanding the difference between them will help you know which one to select for your purpose.

A **sine wave**, such as the one in VCO-2, has only a single fundamental frequency, with no harmonic overtones at all (although that's an ideal that real-world synthesizers don't achieve perfectly). A sine wave's timbre doesn't change when it's filtered; it can only be made louder or softer. All other periodic waveforms are made up of combinations of sine waves of varying frequencies and levels. As a tone, it provides body; as a modulator, it's the most common waveform for vibrato.

A **square wave** has a very rich series of overtones to the fundamental, theoretically infinite, so there's lots to play with. But it emphasizes the odd-numbered harmonics (third, fifth, seventh and so on), so it has an aggressive edge to it. If a square wave sounds distorted to you, there's good reason. "Clipping" distortion is what happens when you overdrive a signal to the point where the tops and bottoms of the waveform flatten out. The harder you clip a sine wave, the more it looks and sounds like a square wave.

A **triangle wave** has a strong fundamental tone with only odd-numbered harmonics, no even (octave) harmonics.

A **sawtooth wave** has a harmonic series with both even and odd harmonics in relative balance, so sweeping a filter across it gives a smooth sweep.

i **!** To hear what all this talk about harmonics and overtones means musically, try this experiment with the JUP-8 V4:

1. Start with the "Default" preset.
2. Turn the SOURCE MIX knob all the way to VCO-1.
3. Push the VCF RES control all the way up.
4. Play a note on the keyboard and pull the VCF CUT control down slowly. You'll hear the filter sweep through the harmonics of the triangle wave.
5. Set the VCO-1 WAVE to the other waveforms and do the same thing. Notice the differences in the harmonics that the filter resonance emphasizes as you change the CUT frequency.

5.5.1. The RECTANGLE wave and PULSE WIDTH Modulation (PWM)

The **rectangle wave** is a relative of the square wave. It occupies the third position of the WAVE switches in VCO-1 and VCO-2. The rectangle waveform is unique because it can generate different series of overtones, depending on the setting of the PWM section of the VCO MODULATOR. A rectangle wave (also called a pulse wave) is a signal that switches between positive and negative values very quickly, with a "plateau" that depends on the pulse width setting.

A wave that switches abruptly between positive and negative values, with no stops to rest at zero in-between, is a square wave; it contains the loudest fundamental. When the PWM FADER is at zero, a rectangle wave sounds identical to a square wave (4th position of the WAVE switch in VCO-1). In this position, the fundamental frequency is dominant.

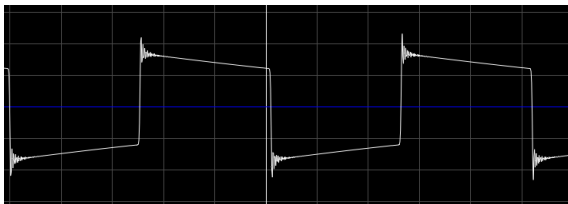

Here is an image of the spectral content of the above waveform:

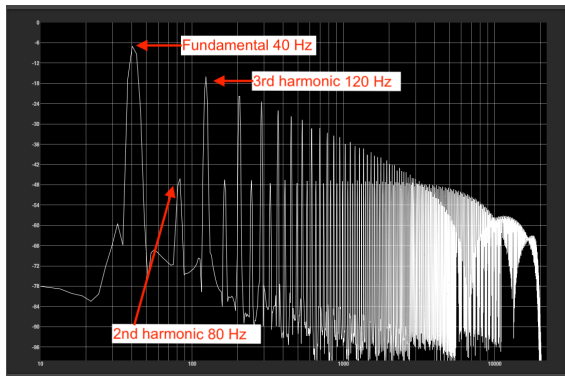

Notice that the fundamental frequency is the loudest, and the even harmonics (2nd, 4th, 6th harmonics) are all much softer than the odd harmonics (3, 5, 7, 9 etc.) and there are many, many of them.

As you raise the PWM control, the pulse width gets narrower and narrower, the wave looks less like a square and more like a spike; the fundamental and lower harmonics get softer and higher harmonic frequencies get louder. At maximum, you get waveform that consists of very quick spikes, holding at zero inbetween. The rectangle waveform now looks like this:



The harmonics of this "spike wave" are dramatically different:

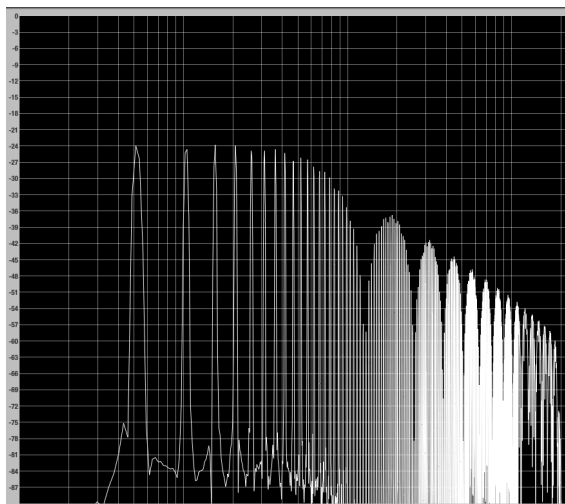

Notice that the first 12 or so harmonics are about equal and much lower than in the spectrum of the wide pulse width wave; the odd harmonics aren't louder than the even ones, and even the fundamental is down at the same level. So, there's not as much bottom end to the sound; it's not as "fat", but it's also less harsh, and you can hear something like comb filtering going on at the high end.

The magic happens in-between these two extremes. At about 50% pulse width modulation, the fundamental and lower harmonics are strong, but the even-numbered harmonics (the octaves) are at about the same level as the odd ones, so the sound is more mellow. If you slowly move the PWM modulation fader when the source switch is in the "M" position,, you can hear it sweep through the different harmonics, emphasizing some, repressing others.



Tip: When you select LFO as the PWM modulation source, you can make one oscillator sound as if it's two slightly out-of-tune oscillators, or a chorus effect.

5.6. SYNC

The SYNC switch allows you to create very complex waveforms and overtones. It synchronizes or locks the frequency of one oscillator to the frequency of the other. Technically, when VCO-1 is synchronized to VCO-2, VCO-1 is forced to restart a new period every time the first oscillator completes its period, even if it hasn't fully completed its current cycle.

- **In the center OFF position**, each VCO's frequency is determined by its own RANGE.
- **When SYNC is to the left (VCO-1 position)**, VCO-1's frequency is controlled by VCO-2.
- **When SYNC is to the right (VCO-2 position)**, VCO-2's frequency is controlled by VCO-1.

In other words, the SYNC switch points to the VCO that is being controlled. Note that the sound of the controlled VCO will be the only one affected by SYNC; the one that is "in charge" will sound normally. Depending on the SOURCE MIX setting, you may not hear any effect at all. When both VCOs are set to the same frequency, the effect is rather small; it's when the frequencies differ that SYNC has the most effect on the tone.



♪: A classic application of SYNC is to send an Envelope signal to modulate the frequency of the VCO that is locked to the other. As it goes through the envelope stages, the sound of the "slave" VCO changes dynamically over time. The Cars used this kind of sound, as did Jan Hammer.

5.7. CROSS

The CROSS fader in VCO-1 controls how much VCO-2 will cross-modulate VCO-1. This may be used for frequency modulation-type effects, noise modulation, or low-frequency modulation.

5.7.1. Frequency Modulation

Frequency modulation is a dramatic synthesizer technique that adds multiple overtones to the sound by modulating VCO-1 with VCO-2. Technically, it generates sum, difference, and multiple frequencies between the two generators. Unlike most musical sounds, this modulation can produce overtones that are not harmonic (that is, not multiples of the fundamental frequency).

When VCO-2's range switch is in the NORM position and its WAVE is set to anything besides Noise, the amount of frequency modulation is controlled from 0% to 100% by clicking on the CROSS fader and dragging up or down. The resulting sound will be more radical as the frequency of VCO-2 differs more from the frequency of VCO-1. Low single-digit settings of the Fine control of VCO-2 result in tremolo/vibrato effects; higher settings produce nonharmonic tones. When CROSS is at maximum, the modulating frequencies overwhelm the fundamental of the oscillator. The result is more noiselike than tonal.

When VCO-2's RANGE is set to 5 (a fourth interval) or 7 (a fifth interval), the result is something like ring modulation with harmonics that are related to the fundamental frequency, so the resulting sound is a little more musical.

 When CROSS is being used, modulating the frequency of VCO-2 with the BEND wheel or ENV-1 (in the VCO MODULATOR section) leads to some dramatic effects. CROSS level is listed as a destination in the Modulations section of the Advanced Panel as "VCO Cross Mod".

5.7.2. Noise modulation

Turn the WAVE knob of VCO-2 to the Noise position to turn on noise modulation.

- When VCO-2 is in the NORM (white noise) range it adds "fuzz" to the tone; it also shifts VCO-1's frequency up, so the keyboard is essentially transposed depending on how high the CROSS level is.
- When VCO-2 is in the LOW (pink noise) range, "static" dominates the sound.

5.7.3. Using VCO-2 as an LFO

The other application of CROSS is when VCO-2 is in the LOW setting and the WAVE is set to Sine, Triangle, or Rectangle. In the LOW range, VCO-2 becomes a fixed-frequency oscillator; it doesn't track the keyboard notes. In the 16' to 8' range with a low CROSS setting, it produces a typical vibrato in VCO-1. At higher frequencies, it becomes a fixed-frequency ring modulation.

That's what the VCOs can do in terms of generating sound. Now we move on to shaping this sound dynamically through the VCF and VCA.

6. HPF AND VCF FILTERS, VCA, AND ENVELOPES

Once the oscillators have generated the sound, and have been balanced by the SOURCE MIX control, they now proceed through the filter section and the final amplifier section, which typically use envelopes to shape the dynamics of the sound over time.

6.1. HPF (High Pass Filter)

This is a non-resonant -6 dB per octave high-pass filter. It gently eliminates low frequencies below its cutoff frequency, while letting high frequencies pass through. It is very useful to remove bass frequencies of a pad sound for example.

At its lowest setting, it has no effect, because its cutoff frequency is at 5 Hz, below the range of human hearing: everything passes through. Double-click the fader to set it to this default "let all frequencies pass" setting.

The sound will become thinner the higher the HPF CUT control is. At its maximum, the HPF crossover point is almost 2 kHz and lower frequencies are made softer at the rate of 6 decibels per octave. Five octaves lower (63 Hz) for example, will be cut by 30 dB.

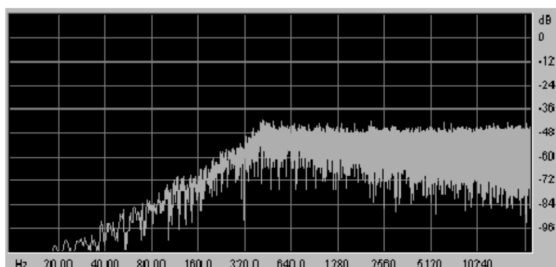

This is a real-time analysis graph of noise going through the HPF with its CUT set to about 400 Hz

6.2. VCF (Voltage Controlled Filter)

This is an emulation of the original Jupiter-8 filter, a major factor of the JUP-8 V4's sound. It is a resonant low-pass filter (LPF) with a switchable slope of -12 or -24 dB per octave; these slopes are much steeper than the slope of the HPF. At -24 dB, when the cutoff frequency is set around middle A, low A will be less than half as loud, and the octave below that will be almost inaudible. Its filtering is more powerful than most loudspeaker crossover networks.

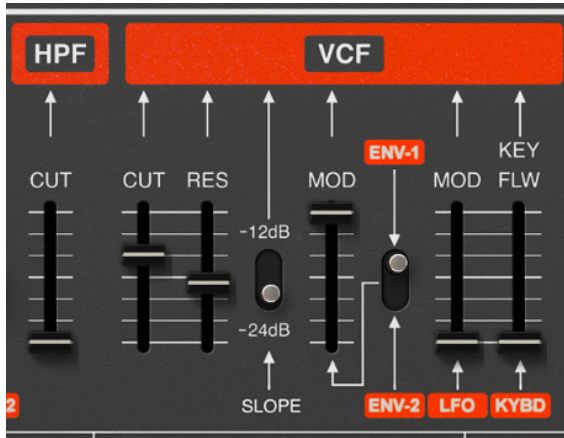

- **CUT (VCF):** This fader sets the cutoff frequency of the filter. The range is from 19 Hz (at the bottom, where almost all sound will be cut off) to 7334 Hz (where the filter is wide open and has little effect).
- **RES:** This sets the resonance of the filter. The resonance amplifies the frequencies near the cutoff frequency. At the bottom, the filter is not resonant. As you increase the RES fader, the filter will become more selective (its peak will become narrower). At extreme settings, the sound will eventually almost “whistle” as the filter begins to self-oscillate.

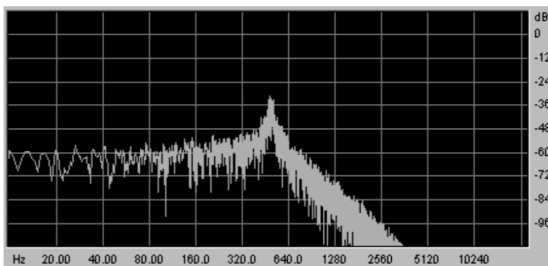

A graph of the frequency curve of the VCF with a CUT of 500 Hz, RES high and SLOPE set to -24 per octave

- **SLOPE:** Switch the filtering slope to -12 or -24 dB/ octave.
- **MOD:** This fader sets how much the filter will be modulated (opened or closed) by one of the ADSR envelopes, as determined by...

- **ENV-1 / ENV-2:** This switch selects whether the envelope MOD source for the VCF cutoff will be ENV-1 or ENV-2;

 If you want the VCF to have the same attack curve as the VCA, choose ENV-2. That would leave ENV-1 free to provide a different frequency and/or pulse width modulation in the VCO MODULATOR.

- **LFO MOD:** This fader sets the level of modulation by the top-panel LFO. Use this parameter to make a wah-wah or switching or sample-and-hold effect.
- **KEY FLW:** (Keyboard Follow) This fader sets how much the filter will track the notes being played. At bottom (no keyboard follow), the filter will sound the same no matter where you play on the keyboard. As you increase KEY FLW, the higher notes will open the filter more than lower ones will, so the right side of the keyboard will be louder and brighter than the left (if some other modulator isn't opening the filter already). In fact, if VCF CUT is very low and KEY FLW is high, bass notes will be almost inaudible while treble notes will play normally.

 To get finer control of settings when controlling knobs and sliders, right-click the mouse (or [Control]+click on Mac) for additional precision. This is useful when trying to set the cutoff frequency precisely, for example.

6.3. VCA [Voltage-Controlled Amplifier]

The VCA is the last step in controlling the sound. It is the final "gate" in the signal path, and is controlled by Envelope 2 which sets the attack, decay, sustain and release times of the sound. ENV-2 determines how loud the signal is at any particular stage of time. A sound can fade in, attack and decay, sustain at a different level, and either stop immediately or fade away slowly when the key is released.

The VCA module itself is very simple, it consists of:

- **LVL (Level):** This fader determines how much the amplifier will be opened by ENV-2. **When LVL is at zero, the amplifier will be closed and no sound will play.** Similarly, even if LVL is at maximum, the VCA must receive some kind of signal from ENV-2 (Attack, Decay, or Sustain faders must be above zero) to open up.
- **LFO MOD:** This fader sets the level of modulation of the VCA by the LFO (Low Frequency Oscillator) on the far left side of the panel, typically causing a tremolo effect. It is a downward modulation, that is, it can lower the signal level, but it can't raise the signal above the LVL setting.

6.4. Envelopes

The Envelopes generate a container for the sound, shaping them over time each time you touch, hold, and release any key on the keyboard. You will find two envelopes on the JUP-8 V4:

- ENV-1 is typically used as a *filter envelope* that modulates the cutoff frequency of the VCF (and can be used as a pitch or PWM envelope for the VCOs)
- ENV-2 is typically dedicated to provide an *amplitude envelope* to open and close the VCA. It can open and close the VCF at the same time if desired, instead of ENV-1. If the levels of all points on ENV-2 somehow get set to zero, you won't hear anything when you play. (The default ENV-2 setting has a very fast attack time with a sustain level set to maximum (1.00) and a fast release, so usually this isn't a problem.)

When playing the keyboard, the envelopes will trigger and modify the voices over time. Each envelope has 4 different controls, labeled **A D S R**:

- **ATTACK:** The Attack is the time that the sound will take to reach its maximum volume once we have pressed a key on the keyboard.
- **DECAY:** The Decay is the time that the sound will take to diminish after the attack portion is complete.
- **SUSTAIN:** The Sustain is the maximum volume level that the sound will reach after the decay is complete, and it will hold at that level as long as you hold the key.
- **RELEASE:** The Release is the time that the sound will take to diminish once the key has been released.
- **KEYFLW:** These switches connect envelope 1 and/or 2 to the keyboard follow. When the switch is "ON", the envelope times - "A", "D" and "R" - will be shorter as you play the higher notes on your MIDI keyboard, to mimic the typically-shorter envelopes of higher notes on acoustic instruments.
- **POLARITY:** Switch to set the polarity for ENV-1:
 - If the switch is on the top, the envelope polarity is positive (this is the usual way to use an envelope).
 - If the switch is on the bottom, the polarity is negative (or reversed). This means that the envelope will close the filter instead of open it, or lower the VCO pitch instead of raise it. A high sustain level will keep the filter closed; a low sustain level leaves it open. The Attack phase now shuts down the filter, starting it loud then fading it, instead of the reverse. Try it and see.

Reversed polarity is very useful to create some inverted effects. Take a look at the preset "Bouncing Balls" to hear an example of this special effect, and the difference between holding the key and releasing it.

7. LFO AND VCO MODULATOR CONTROLS

Now that we've covered the envelopes, let's look at the left side of the top panel, which is dedicated to producing and sending modulations to various destinations.

7.1. LFO (Low-Frequency Oscillator)

The top-panel LFO is typically used to create a vibrato effect (when the LFO modulates the frequency of one or both VCOs, which are "audio frequency oscillators") and/or a "wah-wah" effect (when it modulates the cutoff frequency of the filter).

There are several other interesting tricks an LFO can do as well.

i: Note that the top-panel LFO is one of three available LFO modules in the JUP-8 V4; two more are hidden in the Modulations section of the Advanced Panel because they weren't available in the original hardware. This one is labeled "LFO 1" in the Modulation Mixer of the Advanced Extensions panel.



- **RATE and HZ/SYNC switch:** The RATE fader sets the speed of the LFO. When the switch to its left is in the upper "HZ" position, the frequency range goes from .035 Hz (incredibly slow!) to 30 Hz (which is in the low end of the audible range). Double-click on the RATE control to set it to its default setting of 1 Hz.

In the **SYNC** position, the speed of the LFO is synchronized to the tempo clock coming from an external sequencer or workstation, the Arpeggio module's RATE control, or the JUP-8 V4's Audio MIDI menu (upper left corner). In SYNC mode, the RATE fader sets the frequency of the LFO as a multiple or a fraction of the tempo. For example, when the tempo is 120 BPM (beats per minute) and LFO RATE is set to 1/4 (quarter note), the LFO will play 2 cycles per second; if LFO RATE is set to 1/8 (eighth note) it will play twice as fast (4 cycles/beats per second), and so on.

In either case, the "LED" above the RATE fader will blink to indicate the speed of the LFO.

- **DELAY TIME:** this sets a delay time between the time a key is pressed and the LFO rises to full effect. At the bottom setting of 0 milliseconds, there is no delay. Double click on DELAY to set it to this. The maximum delay time is 3.8 seconds.
- **WAVE:** This sets the LFO's waveform to one of four options:
 - Sine: this is the typical wave for vibrato and tremolo
 - Saw tooth: a series of slopes, special effects
 - Square: alternates between high and low pitches, when sent to the VCO it produces a trill
 - Random (Sample and Hold): produces a different level each period, at random
- **FREE/RETRIG SWITCH:** This switch determines whether the LFO is restarted or *retriggered* when you play a key on the keyboard, or runs at a constant rate ignoring the keyboard (FREE). Retriggering only happens for the first key played after all keys are released.

7.2. VCO Modulator

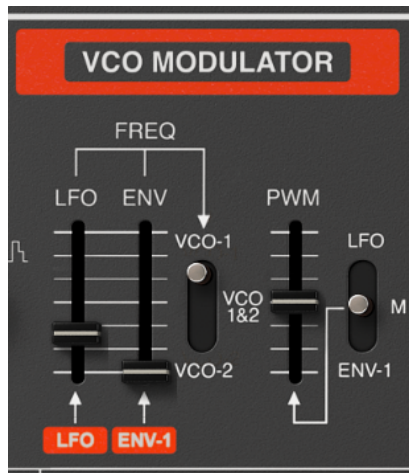

This section of the top panel is where you route signal from the LFO or ENV-1 to control the pitch of either or both VCOs for vibrato and pitch envelope effects. If an oscillator's WAVE switch is in the Rectangle/Pulse position, this is where you control the pulse width.

- **LFO to FREQ:** Raise this fader to send the front panel's LFO to modulate the frequency of the VCO(s) selected by the switch to the right.



The LFO may also be routed to both VCOs by using the MOD wheel and controls to the left of the keyboard.

- **ENV to FREQ:** Raise this fader when you want the pitch of the VCO(s) selected by the switch to the right to follow the attack/decay/sustain/release curve of ENV-1.

A pitch envelope modulates the frequency of the waveform over time. If there is no pitch envelope (that is, if all the envelope ADSR controls are off, or if ENV to FREQ fader is set to zero) each key will play its normal pitch. If the pitch envelope goes positive for a time period, the frequency will go sharp; as the envelope level falls, the pitch will return to its normal frequency.

 **I**: To make the frequency go flat from the normal pitch when you strike a key, set ENV-1's POL switch to the down position.

- **MODULATOR ASSIGNMENT SWITCH:** This is a 3- position switch that takes the inputs from the LFO and ENV faders to its left and applies them to the frequency of VCO-1 (up position), VCO 1&2 (middle) or VCO-2 (bottom position).

 **I**: Note that when you modulate a VCO that is in the SYNC position, its timbre will change, but its pitch will stay the same.

- **PWM (Pulse Width Modulation) fader:** If a VCO's WAVE switch is in the Rectangle/Pulse position, this determines the width or *duty cycle* of the wave, from a square wave to a spike wave, which changes its sound dramatically. See [The RECTANGLE wave and PULSE WIDTH Modulation \(PWM\) \[p.35\]](#) for more information about rectangular waves. Three different modulation sources can be applied to pulse width, as determined by the switch to the right:
 - **LFO:** The pulse width will be varied by the LFO.
 - **M (Manual):** Use this position to set the width of the rectangle waves to a fixed or static setting. When the PWM fader is at the bottom (0%), the rectangle wave is identical to a square wave. When it is at 100%, it is a spike wave with a very short duty cycle and very little fundamental tone.
 - **ENV-1:** In this position, the rectangle wave's pulse width will vary over time according to the ADSR settings of Envelope 1.

8. ADVANCED PANEL

When the Roland Jupiter 8 synthesizer was introduced in 1982, digital signal processing was in its infancy; a digital reverb processor (like the Yamaha Rev-7) cost as much as a small synthesizer. Visual display technology was dominated by 2x16 alphanumeric displays; having a full graphic screen on a synthesizer was unheard of, except in the Fairlight/ Synclavier category. Adding additional features to the original Roland Jupiter 8 keyboard would have meant adding more hardware, weight, cost, and complexity.

Thanks to the digital revolution and low-cost, high-definition, full-color displays, these limitations no longer apply. Today, Arturia's software is advanced enough to faithfully model not only the behavior and sound of the old analog circuitry, but to add features that would have been inconceivable in 1982. Built-in effects and much more flexible modulation paths are standard features today, enhancing the creative possibilities for musicians and producers.

These 21st-century features are in the Advanced Panel "under the hood" of the JUP-8 V4. Click on the word **Advanced** on the upper right corner of the JUP-8 V4 window to see them.

 ! This makes the JUP-8 V4 window much taller, so you may need to use the **Resize Window** command if you need to see the lower parts of the window at the same time.

There are four different displays in this panel: Modulations, Sequencer, Keyboard, and Effects.

8.1. Advanced Modulations



The Advanced Modulations panel adds **two more LFOs**, each of which may be sent to two destinations in independently-adjustable levels. These LFOs can do anything that LFO-1 (already explained in [Chapter 7 \[p.43\]](#)) can do, plus much more.

On the right side of the screen is the **Modulation Mixer**, which allows you to take every possible mod source of the JUP-8 V4, combine it with another mod source, and route that combination to every possible modulation destination. Instead of the 3-position switches found on the front panel, each of the three mod mixer outputs may be routed to one of 53 possible destinations--if you can imagine it, it can be done.

8.1.1. LFO 2 and LFO 3

These two low-frequency oscillators are similar to the LFO on the front panel, with additional flexibility and features. Both of them have the same controls.

8.1.1.1. To select an LFO Waveform:

The current waveform and its speed is shown on an oscilloscope display of the window. Click on the name of the wave under the LFO wave display, and make a selection from the menu:



8.1.1.2. LFO 2 and 3 controls

- **Single/Cycle:** In Cycle mode, the LFO operates normally, continually generating the selected waveform. In Single mode, the LFO generates only one complete waveform starting when you play the first key after a release, then stops until triggered again.

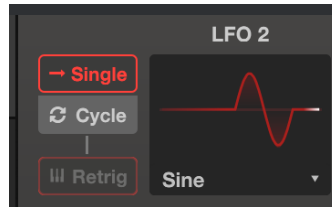
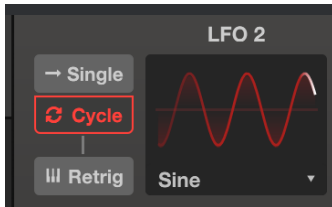

Tip: If you need an additional envelope, you can use a slow Single Saw wave from LFO 2 or 3 as an envelope (for example, assigned to pitch or PWM). The Warp control allows you to sculpt the "envelope" in unique ways, and the Destination Level knob can make the envelope positive (clockwise from "noon") or negative (counter-clockwise).

- **Retrig:** When this retrigger field is on, the LFO will restart from zero each time you play the first key after all keys are released.



- **Rate (Hertz or Sync):** This determines the speed of the LFO. Double-click the knob to set it to its default value of 1 Hz, or 1/4 in Sync mode.

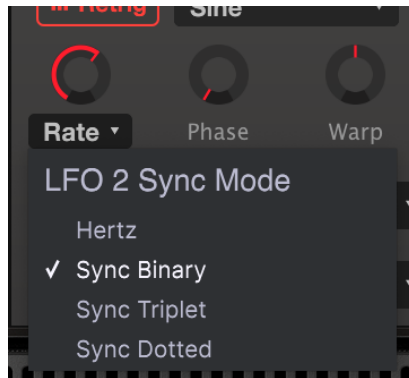

There are four different ways to set the speed of the LFO:

- **Hertz:** sets the LFO rate in a range of 0.01 to 200 Hz (cycles per second), independent of tempo.
- **Sync Binary:** the LFO rate is synchronized with tempo, with a setting of 1/4 (quarter note) equalling one cycle per beat.
- **Sync Triplets:** Tempo-synchronized, where 1/4 equals a quarter-note triplet per beat (faster).
- **Sync Dotted:** Tempo-synchronized, where 1/4 equals a dotted quarter-note per beat (slower)

If the Rate Type is one of the Sync modes, the LFO speed range is from 1/32 to 8/1 of the master clock . In this case the LFO speed selections will be musical multiples or fractions of the current tempo of your DAW, or the tempo set in Audio MIDI Settings.

- **Phase:** adjusts the phase of the LFO between 0° and 360°. At the 12:00 position, the phase is 180° (a half-cycle out of phase), so the waveform starts at a different point of its cycle when retriggered. For example, a sine wave that normally starts from zero and rises will go down from zero when retriggered. Different waveforms have different starting points; experiment to get the phase behavior you need.

- **Warp:** This control, when turned either direction from the 12:00 position, intentionally distorts the phase of the LFO wave, at the extreme settings turning it into a spike. Depending on the LFO wave, the positive or negative setting of Warp determines whether the "resting" pitch will be sharp or flat.
- **Fade:** Turn this knob clockwise to introduce a gradual fade-in of the LFO level when you play a key. The range is from 0 milliseconds (no fade in, immediate action) to 20 seconds.
- **Unipol/Bipol:** When this button reads Unipol (Unipolar), the LFO waveform is always positive, it never goes below zero; the waveform oscillates only in the upper half of the display. For example, when using it to make a vibrato, which normally goes sharp and flat, in Unipolar mode, it only swings sharp. Click on the button icon to return it to Bipol (bipolar) operation. In this mode, the waveform oscillates positive and negative, i.e., sharp and flat vibrato.
- **Poly:** When the Poly (polyphonic) button is lit, the LFO waveform is independent for every note that is played, so that the modulation stage of each note depends on when it was played. When Poly is off, there is a single LFO waveform for all notes being played, so that the modulation for all notes rises and falls in unison.
- **Dest 1 and Dest 2 (Destinations):** These pulldown menus and associated level controls determine where the LFO is being sent to, and how much it will affect that destination. Click on the arrow of the Dest 1 or Dest 2 field to reveal the pulldown menu:

LFO 2 Destination 1					
Global	Oscillators	Filter	Envelopes	Mods / Seq	Effects
None	VCO1 Coarse	HPF Cutoff	Env1 Attack	LFO2 Rate	FX 1 Dry/Wet
Unison Detune	VCO2 Coarse	VCF Cutoff	Env1 Decay	LFO2 Phase	FX 2 Dry/Wet
Pan Spread	VCO1+2 Coarse	VCF Resonance	Env1 Sustain	LFO2 Warp	FX 3 Dry/Wet
Portamento	VCO2 Fine Tune	VCF Env Mod Amt	Env1 Release	LFO2 Fade	FX 1 Param
LFO1 Rate	VCO1 PW	VCF LFO Mod Amt	Env2 Attack	LFO3 Rate	FX 2 Param
LFO1 Delay	VCO2 PW	VCF Key E Mod A	Env2 Decay	LFO3 Phase	FX 3 Param
Atp Rate	VCO PW Mod Amt		Env2 Sustain	LFO3 Warp	
	VCO Cross Mod		Env2 Release	LFO3 Fade	
	VCO Mix		VCA Env 2 Amt	Mod Mixer Amt	
	VCO LFO Mod		VCA LFO Mod Am	Seq Rate	
	VCO Env1 Mod			Seq Mod Mult.	
				Seq A. Decay	
				Seq A. Amt	
				Seq Glide	

- The **Dest Level** or Modulation Amount knobs have a default setting of 12:00, which is the "zero" position. Turn clockwise to send the LFO to the destination as a positive signal, or turn counter-clockwise to send the modulation as a subtractive signal.

8.1.2. Modulation Mixer

The right half of the Advanced Modulations screen allows you to combine any two modulation sources with any of six different mathematical operations, and send them in varying degrees to three different destinations. It gives you powerful creative control of how and when modulations occur, and includes live performance inputs like velocity, aftertouch, and mod wheel.

The best way to understand how this works will be to provide a simple example. But first, here's a list of the parameters:

Parameter	Description	Range
MOD MIXER SOURCES (L & R)	The two parameters you'd like to combine or use	11 options
MOD MIXER TYPE	Decides the math process that will be applied	6 options
MOD MIXER DESTINATIONS 1, 2 & 3	Where the combination will be sent	54 options
MOD MIXER MODULATION AMOUNT	How much modulation will be sent to the destination	0.00 - 1.00 in steps of 0.001 (with CNTL key held, or with right click)



i: The Modulation Mixer, besides combining two modulation sources, may be used to map a single mod source controller to several destinations in different amounts and polarities, or to process a source with more flexibility.

8.1.2.1. Modulation Mixer Example

Let's combine two LFOs to illustrate just one possible use of the Modulation Mixer.

1. Start with the Default preset.
2. Set LFO 2 to generate a Sine wave, with Rate set to Sync Binary at a speed of 1/1. Set LFO 3 to generate a Saw Down wave, with Rate set to Sync Binary at 1/16.
3. Set the **primary (left) MOD SOURCE** to LFO 2, and the **secondary (right) MOD SOURCE** to LFO 3.
4. The center MOD MIXER TYPE menu should be set to **Sum** and the **Mod Mixer Amt** knob to its right set to, well, anything, but we're using 0.400.
5. Set one of the MOD MIXER DESTINATIONS (it really doesn't matter which one of the three) to **VCO1 Coarse** and its **Mod Mixer Modulation Amount Knob** (to the right of the destination menu) to about half-way up (0.500). The waveform display should look something like this:

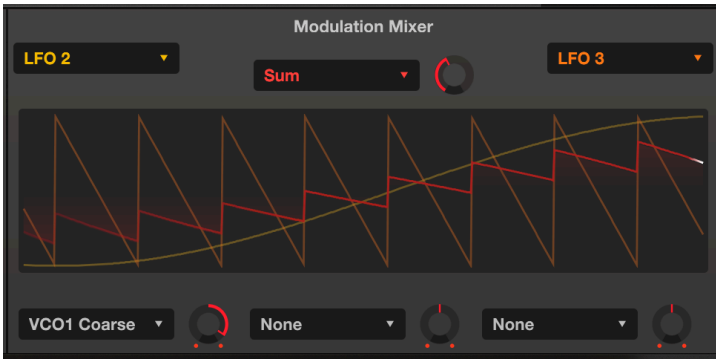

The color-coded lines of the display give you a clear idea of what's going on:

- The long yellow line is the slow sine wave from LFO 2.
- The orange line is the faster sawtooth wave from LFO 3.
- The red "small sawtooth" is the result, the actual output of the Modulation Mixer.

1. Turn the **SOURCE MIX** knob counter-clockwise so you hear only VCO-1, and play any key on the keyboard.
2. Slowly move the **Mod Mixer Amount** knob (next to "Sum") up and down between 1.00 to 0.00 and watch the red output waveform. Lower amounts decrease the impact of the Sawtooth wave, as seen in the smaller spikes that eventually disappear into the Sine wave.
3. Return the Amount to 1.00 and observe the waveform: the sawtooth wave is "surfing" on the sine wave.
4. Change the **MOD MIXER TYPE** to Diff (Difference) and observe: now the wave curves up and ends with a sharp drop down. Mathematically the results are at opposite extremes, as are the results here.
5. Try changing the TYPE to Multiply, and to Divide. The differences in the math processes are even more extreme, and though the results are too technical to describe, we think you'll agree that the output waveforms are equally complex and useful.
6. Select TYPE: Crossfade. This one's easy: with the Amount at 1.00, only the LFO 3 wave passes through, resulting in a Saw Down wave output. At a value of 0.00 only the LFO 2 wave passes through, resulting in a Sine wave output.

8.1.2.2. Mixer formulas

The formulas used to calculate each Type are displayed below in a single chart to see how each formula differs from the others. "Source" is the left or primary input, "Mod" is the right or secondary input, and "Amount" is the setting of the Mod Mixer Amount knob:

Type	Formula
Multiply	Source * Mod * Amount + Source * (1 - Amount)
Sum	Source + (Mod * Amount)
Diff	Source - (Mod * Amount)
Divide	Source / (Amount + Mod)
Crossfade	Amount crossfades Source and Mod
Lag	Source only; time-based low-pass filtering effect. At 0.500, it takes 500 ms to reach the source's amplitude, at 1.00 (full) it takes 5 seconds.

i: The output of the equations is not allowed to exceed the values of -1.00 and +1.00.

i If either of the sources is polyphonic, then the Mod Mixer output is polyphonic; otherwise, the output will be mono.

8.1.2.3. Modulation Mixer Output to multiple destinations

Once you have set up the modulation mix that you want, the three pulldown menus and level controls at the bottom of the mixer allow you to send it to three destinations, control how much modulation is sent to each, and the polarity of the modulation (additive or subtractive.)

Mod Mixer Destination 1					
Global	Oscillators	Filter	Envelopes	Mods / Seq	Effects
None	VCO1 Coarse	HPF Cutoff	Env1 Attack	LFO2 Rate	FX 1 Dry/Wet
Unison Detune	VCO2 Coarse	VCF Cutoff	Env1 Decay	LFO2 Phase	FX 2 Dry/Wet
Pan Spread	VCO1+2 Coarse	VCF Resonance	Env1 Sustain	LFO2 Warp	FX 3 Dry/Wet
Portamento	VCO2 Fine Tune	VCF Env Mod Amt	Env1 Release	LFO2 Fade	FX 1 Param
LFO1 Rate	VCO1 PW	VCF LFO Mod Amt	Env2 Attack	LFO3 Rate	FX 2 Param
LFO1 Delay	VCO2 PW	VCF Key E Mod A	Env2 Decay	LFO3 Phase	FX 3 Param
Arp Rate	VCO PW Mod Amt		Env2 Sustain	LFO3 Warp	
	VCO Cross Mod		Env2 Release	LFO3 Fade	
	VCO Mix		VCA Env 2 Amt	Mod Mixer Amt	
	VCO LFO Mod		VCA LFO Mod Am	Seq Rate	
	VCO Env1 Mod			Seq Mod Mult.	
				Seq A. Decay	
				Seq A. Amt	
				Seq Glide	

Make your selection from the pulldown menu, then turn the knob to the right (clockwise) for a positive modulation, or to the left (counter-clockwise) for a negative modulation. Double-click the knob to set it to the default "12:00" (zero, no modulation) position.

8.1.2.4. FX as Modulation Mixer Destinations

In the pulldown menu above, the last six destinations involve the three effects (FX) we will cover later in the Effects section, but they bear some extra explanation here.

The labels "FX 1" etc. will be replaced by the name of the effect in each slot once you choose them. For example, "FX 1 D/W" might become "Reverb 1 D/W", FX 2 DW might become "Delay 2 D/W" etc.

D/W stands for Dry/Wet, the ratio between the direct signal and the effected signal. For example, if Reverb 1 D/W is set to 0.00% (Dry) there will be no reverb, and if it is 100.00% (wet) it will ONLY be reverb.

The other FX mod destinations (FX 1 Param, etc.) will change to the most useful effect parameter for the effect type. See [Modulation Mixer FX Parameters \[p.75\]](#).

8.2. Sequencer

Before there were computer sequencers with lots of memory, early electronic musicians used hardware step sequencers with multiposition switches determining each pitch. The Arturia JUP-8 V4 pays homage to those days with a 32-step sequencer section in the Advanced Panel.

It has a polyphonic **Notes Sequencer** to create melodic lines, harmonic progressions, and rhythmic lines (when the **Pitch Routing** on the lower right corner is going to one or both VCOs). It also has a **Mod Sequencer** that can sequentially modify parameters (e.g., the cutoff frequency of the VCF, or the width of the VCO square waveform) step-by-step.

When the Advanced Panel is open, click on the "Sequencer" button on the left side to display the Sequencer subpanel. Click on the Notes Sequencer tab or the Mod Sequencer tab to display and edit that sequence.

To play the sequencer simply turn the master Sequencer and Notes Sequencer's power switches on (red) and hold any key(s) on the keyboard. The Notes Sequencer is an offset generator that will play its melody according to the keys you press: each step of the sequence is defined not as a particular note (like "A b") but as an interval: "7 semitones above whatever key(s) are being played".

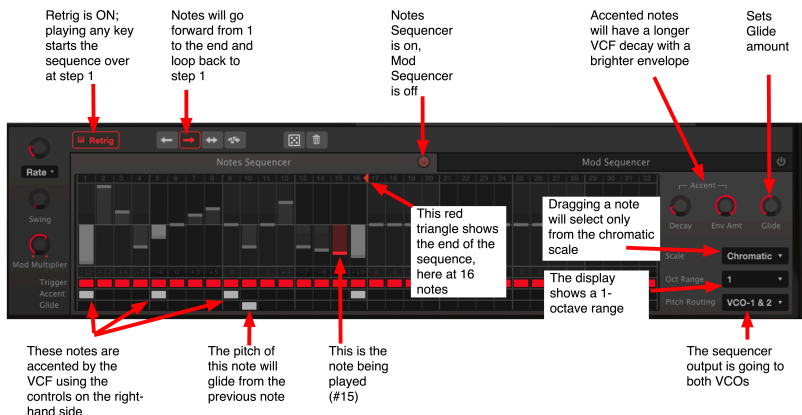

8.2.1. Notes and Mod Sequencer shared parameters

The following controls affect both sequencers simultaneously:

8.2.1.1. Sequencer Speed controls

- **Rate:** The speed of the sequencer may be set independently as BPM (Beats Per Minute) in a range of 6 to 600 BPM, or set as a multiple of the master clock tempo from 8 (slow, 1 step per 8 measures) through 1/4 (1 step per beat) to a maximum of 1/32 (8 steps per beat).

Click on the name field to set the **Sequencer Sync Mode** to BPM, Sync Binary, Sync Triplet, or Sync Dotted modes. As explained in the LFO section [p.47], Sync Binary plays the sequencer in standard quarter time, (1 step per quarter), Sync Triplet plays the steps in fast triplets, and Sync Dotted plays each step at time value plus a half (e.g., dotted quarter at 1/4, dotted eighth at 1/8) synchronized to the external tempo clock.

- **Swing:** At the default setting (full counter-clockwise, 50%), no swing is applied to timing of the steps. As you increase this control, the timing between the steps is "swung" from a strict timing towards a triplet timing for a less-robotic, more human feel.
- **Mod Multiplier:** This determines the speed of the Mod Sequencer relative to the speed of the Notes Sequencer. At a setting of 1 (knob position about "1:30") both sequencers go at the same rate. Turning counter-clockwise reduces the speed of the Mod Sequencer to a minimum of 1/32 the speed, (i.e., one step of Mod for every 32 steps of Notes). Turning clockwise increases the speed of Mod to a maximum of 6 steps per step of Notes. **Double-click the knob** to return the Mod Multiplier to its default of 1.

8.2.1.2. Retrig [Retrigger]

When **Retrig** is lit, the sequence will restart from the beginning whenever you play the keyboard after you've released all notes. If you play legato, it will not retrigger.

When Retrig is off, the sequencer continues going through its steps at all times. Playing the keyboard will "jump in" to whatever step the sequencer is currently on.

8.2.1.3. Sequencer Playback Mode icons

The sequencers can go through their steps in the following orders, determined by the pulldown menu to the right of the Retrig icon:

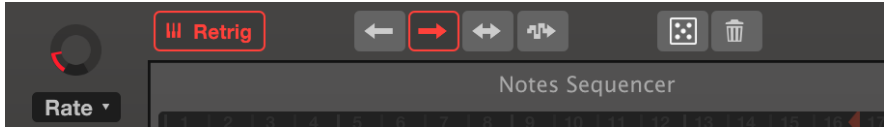

the Notes Sequence length has been set to 12. Notes to the right of 12 will not be played

- **Forward:** (Right pointing arrow, shown in red above) Steps progress forward from the first note to the last, then restart at the first.
- **Backward:** (Left arrow) Steps go backwards from the last note to the first, then restart at the last.
- **BackAndForth:** (Left and right arrow) Steps start at #1, reach the last note and repeat it, then play backwards to the first and repeat it.
- **Random:** (Sample and hold arrow) Steps are played in random order.

8.2.1.4. Sequencer Randomizer [dice icon]

Just above the Notes sequencer tab is a small square with five dots in it. Click and drag up in this icon to change the step values in the currently-displayed sequencer randomly around their current values. Dragging higher in the square will make bigger changes, dragging up a little bit makes minor changes. The Notes sequencer will randomize according to the **Scale** and **Oct Range** chosen on the right side of the screen. The randomizer will only apply to the chosen sequence length in both the Notes and Mod sequencers.

i : If the random sequence generator makes changes that you don't like, don't forget the undo arrow in the bottom toolbar.

8.2.1.5. Sequencer Reset [trash icon]

Click on this to reset the values of each step in the sequence to zero. It will only trash the values of the currently-displayed sequencer, for example, resetting the Notes Sequencer will not reset the Mod Sequencer.

8.2.1.6. Sequence Length

You can change the length of the sequence to any value you wish between 1 and 32. The Notes Sequencer and the Mod Sequencer may be set to different lengths. To change the length, the sequencer must be turned on.

In the bar of step numbers from 1 to 32, **click on the small red left-facing triangle** and drag it in either direction.

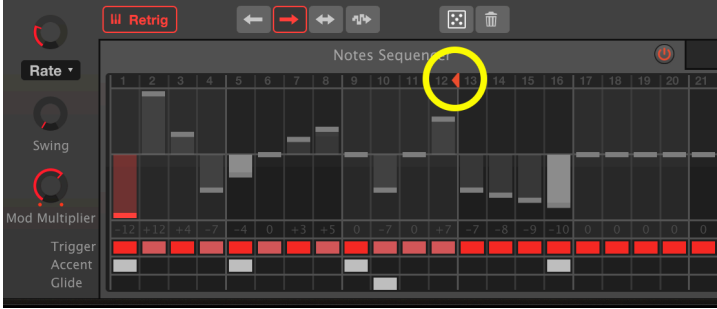

the Notes Sequence length has been set to 12. Notes to the right of 12 will not be played

8.2.2. Notes Sequencer

Hold any keys on the keyboard to start the Notes Sequencer when its red power icon is lit. The Notes Sequencer is arranged to play in semitone steps, with the zero or center value representing whatever note(s) you play on the keyboard. Each step can be up to 24 semitones above or below the center note.

For example, if you hold an "A" on the keyboard and a step value is -1, that step will play an A^b. If you hold a middle "C" on the keyboard, the step value of -1 will play a B^b; a step value of +24 will play a C two octaves higher.

Click in a step field and drag to set the step to the value you want. The step values will be restricted to the current scale. For example, if the scale is set to Major, dragging a step upwards will go through the values 0-2-4-5-7-9-11-12 etc. and won't let you set a step to any value outside of that scale.

8.2.2.1. Scale

On the right side of the Notes sequencer screen, click on the pulldown menu next to **Scale** to see your available options:

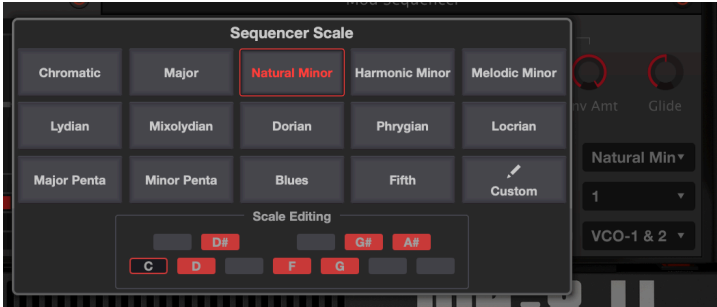

The Sequencer step values will select from the Natural Minor scale. At the bottom outlined in red are the notes that would be available from the C minor scale, just for clarification: any note on the keyboard will play its own particular Major key

There are 15 possible scales to choose from. In Chromatic scale, any semitone can be selected. All the others restrict selections (and playback) of steps to the tones in that scale, whether major or minor, modal, pentatonic, blues, fifth (only the root and fifths of notes will play) or to a Custom scale you design yourself. If you're not familiar with a scale, select it to see the steps of the scale displayed at the bottom of the popup window.

i!: If you program steps using one scale, and then switch the Scale to another, any notes that are not "legal" in the new scale will play back as the nearest allowable note, instead of the semitone that you originally programmed. But scale choices are not destructive; if you program a sequence, then try different scales that alter your sequence, going back to your original scale (or to Chromatic) will recover the original sequence.

8.2.2.2. Trigger

Directly below each step's note value number is a red, pink, or black block in the **Trigger** row. Click on this block to determine the trigger behavior of the step:

- **Red** trigger blocks denote a step that will trigger both ENV-1 and ENV-2, typically opening the VCF and VCA.
- **Pink** blocks denote a step that does NOT trigger the envelopes; it will change the pitch (if the value is different) but the envelope will keep going through its existing cycle. If you think of each step as a sixteenth note, a red step followed by 3 pink steps will sound as a quarter note.
- To insert a rest, right-click or CNTL-click to turn the block **black**. No sound will emit from that step if the release time of ENV-2 is set to zero.

i!: The effect of all triggers depends upon the envelope curves and the VCF CUT settings. To hear the effect of a red (triggered) vs. a pink (non-triggered) step, adjust VCF CUT down or up while the sequence is playing.

8.2.2.3. Accent

Below the Trigger row is the **Accent** row. Clicking on any of these blocks will turn it white, and that step will be accented by an independent envelope that opens the VCF, (provided that the filter isn't already open from an envelope, or its CUT being set wide open).

The sound of the accent depends on the settings of the **Accent Decay** and **Env Amt** controls on the right side of the Sequencer window (above **Scale**).

Turn the Env Amount clockwise to start accenting the notes. The **Accent Decay** knob sets the length of the accent.

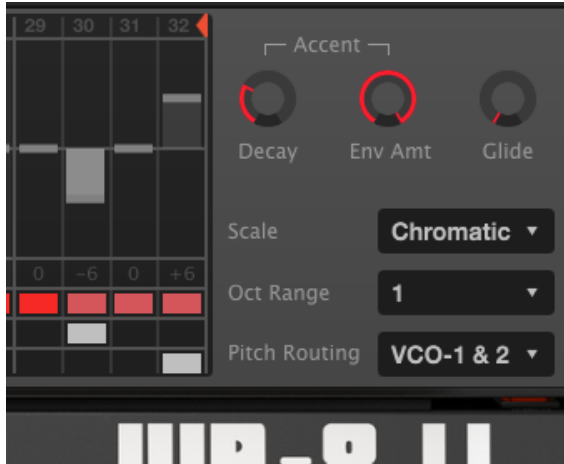

Step 29 has a red trigger box; that note will trigger the main envelopes. Steps 30-32 have pink trigger boxes and won't trigger the main envelopes, but Step 30 has an accent, and will open the VCF with an accent envelope with an immediate attack and decay time set by the Decay knob. The Env Amount is at maximum. The last step, #32, will glide in pitch

8.2.2.4. Glide

Click on any box in this row to introduce a portamento effect to the start of that step. The amount of Glide will depend on the setting of the Glide knob to the right of the Accent controls. At full counter-clockwise there is no glide; at full clockwise (1) it will take the entire step length to get to its target. At a setting of 0.500 (12 o'clock), the glide will reach its target halfway through the step.

8.2.3. Mod Sequencer

To see the **Mod Sequencer** in the Sequencer Window, click on its tab. To turn it on, click on the power icon on the right side of the tab to turn it red.

The Mod Sequencer is similar in operation to the Notes Sequencer, except that instead of sending out note messages in semitones, it sends out a sequence of modulation values that can be varied from -1.000 to +1.000 for each step. These modulation values can be sent to three different modulation destinations in varying amounts and polarities.

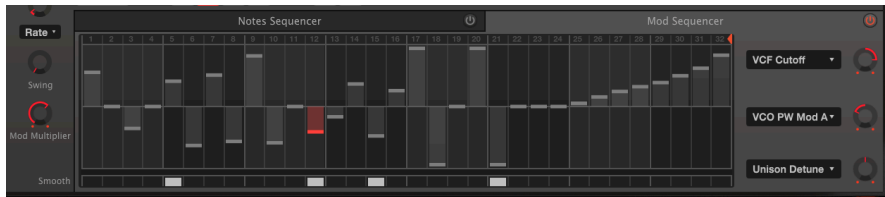

The Mod Sequencer is ON, the Notes Sequencer is off. It's a 32-step sequence that happens to be at step 12, whose Smooth parameter is on. This sequence will increase the VCF cutoff, lower the Pulse Width Modulation amount, and make no change to Unison Detune

8.2.3.1. Smooth

Clicking the **Smooth** box for a step of the Mod Sequencer is similar to clicking the **Glide** box for a step in the Note Sequencer: instead of jumping directly to the step value from the previous one, it smoothes the transition from the previous step.

8.2.3.2. Mod Sequencer destinations

The three pulldown menus and associated knobs on the right side send the Mod Sequencer output to three different destinations in varying amounts:

- If the knob is in the "12:00" position (like the Unison Detune destination in the illustration above), no modulation will be sent even though a destination is chosen.
- Turn the knob to the right to send a normal output level (e.g., opening a filter when the step is positive, and closing the filter when the step is negative)
- Turn the knob to the left to send a reversed output (e.g., closing a filter when the step is positive, opening it when the step is negative)

Click on the name field next to the knob to select any of 54 mod destinations from the popup menu:

Mod Sequencer Destination 1					
Global	Oscillators	Filter	Envelopes	Mods / Seq	Effects
None	VCO1 Coarse	HPF Cutoff	Env1 Attack	LFO2 Rate	Delay 1 Dry/Wet
Unison Detune	VCO2 Coarse	VCF Cutoff	Env1 Decay	LFO2 Phase	Reverb 2 Dry/Wet
Pan Spread	VCO1+2 Coarse	VCF Resonance	Env1 Sustain	LFO2 Warp	FX 3 Dry/Wet
Parlamento	VCO2 Fine Tune	VCF Env Mod Amt	Env1 Release	LFO2 Fade	Delay 1 Time
LFO1 Rate	VCO1 PW	VCF LFO Mod Amt	Env2 Attack	LFO3 Rate	Reverb 2 Dec
LFO1 Delay	VCO2 PW	VCF Key E Mod A	Env2 Decay	LFO3 Phase	FX 3 Param
Arp Rate	VCO PW Mod Am		Env2 Sustain	LFO3 Warp	
	VCO Cross Mod		Env2 Release	LFO3 Fade	
	VCO Mix		VCA Env 2 Amt	Mod Mixer Amt	
	VCO LFO Mod		VCA LFO Mod Am	Seq Rate	
	VCO Env1 Mod			Seq Mod Mult.	
				Seq A. Decay	
				Seq A. Amt	
				Seq Glide	

This is the same list available to the Modulation Mixer and LFOs 2 and 3. Note that the Mod Sequencer can actually affect the Sequencer Rate, and its own speed relative to the Notes Sequencer by changing the *Sequencer Mod Multiplier*, which was explained earlier: [Sequencer Speed controls \[p.54\]](#).

If the Mod Sequencer is assigned to **Seq Glide**, you are able to set independent glide times for each note of the Notes Sequencer. **Seq A. (Accent) Decay and Amt** let you change the level and length of the accent for each accented note in the Notes Sequencer.

Note that the Effects destination names change depending on which effect is in each slot. In the picture above, FX 1 is delay, FX 2 is reverb, and there's nothing in the third slot. See [FX as Modulation Mixer Destinations \[p.53\]](#).

8.3. Keyboard

This page of the Advanced Panel allows you to map four different performance inputs (Velocity, Aftertouch, Mod Wheel, and Keyboard Tracking) to 3 modulation destinations each. Each input can be shaped by a bezier curve that you can customize for the purpose:

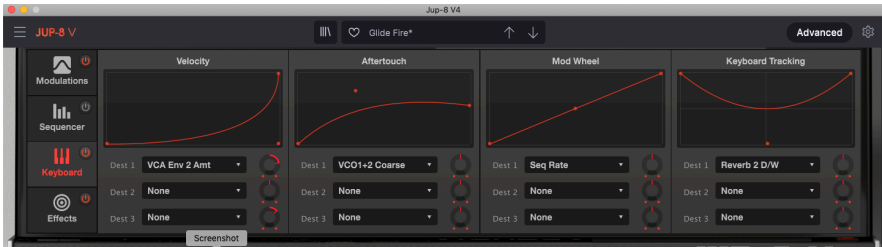

In the illustration above:

- Velocity is mapped to the VCA, with a curve that will increase the volume the harder you play. This makes the JUP-8 V4 velocity-sensitive. If Velocity is sent to VCF Cutoff, playing harder will make the sound brighter.
- Aftertouch is mapped to the VCO pitch so you can bend the pitch using the keyboard aftertouch instead of the Bend toggle. The curve is set with a lower upper limit so it doesn't bend too far. JUP-8 V4 supports both Channel Aftertouch and Poly Aftertouch inputs, automatically detecting which one your controller is sending.
- Mod Wheel is mapped to Sequencer Rate in a straight line, so it will play faster as you move the MOD wheel up.
- Keyboard Tracking is mapped to Reverb Dry/Wet, with a "U curve" that will down the bass and treble ends of the keyboard in reverb, but notes in the middle of the keyboard will be relatively dry.

Dest 1, 2 and 3 pulldown destination menus and associated value knobs work in the same manner as they do in the [Mod Mixer \[p.52\]](#) and [Mod Sequencer \[p.60\]](#).

8.3.1. Adjusting the performance modulation curves

Each of the four Keyboard sources has a curve window so you can alter the effect of the parameter.

To adjust a curve simply click and drag on any of the 3 red dots (beginning, middle and end). The beginning and end points may be higher or lower; the middle point may be moved anywhere on the screen to make the curve shape you want.

The curve is a multiplier of the value to let you customize how responsive the Keyboard input is. Some examples from the illustration above:

- A default straight line from the lower left corner to the upper right corner means the Keyboard source will be sent in a linear way to the Destinations. In our example, the Mod Wheel will smoothly and linearly go from minimum to maximum.

 Keep in mind that if you simply want to reverse a curve, e.g. if you want the Mod Wheel to slow down the Sequencer Rate instead of speeding it up, you could leave the curve as it is and turn the Destination knob counter-clockwise from the center '12:00' position.

- A bowed curve means the Keyboard source will be multiplied (bowed up) or divided (bowed down) for part of its travel. In our example, Velocity won't have much effect for lower- and medium-velocity notes, it will have full effect for high velocity notes. The Aftertouch bends the pitch immediately, but harder pressing won't make as much difference.
- The height of the start and end points determines the limits of the curve. For example, if you're using Aftertouch for pitch bend but it bends the notes too far, you can lower the end point to make the maximum bend only a whole note. (You could also do this by turning the Destination Level knob down.)
- You can reverse a curve so a low input becomes a high output, or so the middle is lower than either end, as in Keyboard Tracking to Reverb Decay Time above.

8.4. Effects

Last but not least of the Advanced Panel pages is the Effects section. This allows you to process the sound of the JUP-8 V4 through three different digital effects at once, with eleven options to choose from for each slot. Any array of effects (for example, reverb, chorus and overdrive) can be customized and saved for each Preset.

To view and edit effects, open the Advanced Panel, and click on **Effects** on the left side to open the window.

8.4.1. Series or parallel module routing

The JUP-8 V4 has a total of three effect modules. Each module can be any one of eleven different effects, or left unused. The modules can be arranged in two different ways:

- a chain of three in series, or
- three parallel effects.



In the example above, we have three effects in series. Notice that under **routing** on the left side, a box with two arrows [-> ->] is highlighted in red. Also, the arrows in the module title boxes are pointing to the right; if the routing was parallel, these arrows would be pointing down.

The signal flows from left to right. First in line is a Parametric EQ; its Dry/Wet fader is "all wet" because it's the kind of effect that should NOT be mixed with the original "dry" signal. Effect 2 is a Chorus; last in line is Effect 3, a Reverb. These two have Dry/Wet faders set to about 50% to mix the signal from the previous module with their own output. Notice that each module has its own **On/Off** or Bypass switch in its upper right corner.

i: It may be necessary to adjust the Wet/Dry balance of an effect in order to hear it or the original signal all the way through the FX signal path.

To turn off all effects press the **Master Effects On/Off** switch on the Effects tab on the far left of the panel.

8.4.2. Selecting an effect

To select an effect, click the name field at the top of the effect module. A dropdown menu will appear; click on the effect you want. A check mark indicates the current selection. After an effect is selected the menu will close automatically. To remove an effect from the signal path, either disable it with its on/off button or select None for that slot.



8.4.3. Enabling / disabling an effect

To enable or disable an effect, toggle the on/off button to the right of the effect name. This is sometimes referred to as a "bypass" switch.

Audio will still pass through the disabled effect to the next effect or the mix output, but it will not alter the audio signal.

8.4.4. Editing the effects

Each effect has its own parameters, which will be described in the following sections.

 When you hover your cursor over an effect control, the numerical value for the parameter is displayed in a text bubble next to the control, and the name of the control is displayed in the lower tool bar on the left side.

8.4.4.1. Reverb

A Reverb effect creates a large number of echoes that gradually fade or "decay". It simulates how the input would sound in a room or a large space.



Control	Description
Predelay	Sets the amount of time before the input signal is affected by the reverb, from zero to 200 milliseconds.
Decay	Determines the length of time the reverb effect will last. <i>Appears as a Mod Destination in the Advanced Modulations window and Mod Sequencer.</i>
M/S Mix	Adjusts the reverb from Mono to an increasingly wide Stereo space.
Input LP Freq	Input Low Pass filter: Filters out the high-frequency content above the chosen frequency. Range 100 Hz to 15 kHz. Default 7661Hz.
Input HP Freq	Input High Pass filter: Filters out low-frequency content below the selected frequency. Range 30 Hz to 10 kHz. Default 44 Hz.
Size	Adjusts the size of the room: counter-clockwise is smaller, clockwise is larger.
Damping	Controls the rate at which the high frequencies decay.
Dry / Wet mix	Controls the balance between the input signal and the effected signal for this effect.

8.4.4.2. Delay

A delay can increase the spaciousness of a sound by providing distinct echoes within the stereo field. It can also be used as a rhythmic counterpoint to accentuate a groove. The Delay Time Sync options let you synchronize the delays with tempo and any other synchronized parameters of the JUP-8 V4, and even allow delays in triplet and dotted times.



Control	Description
Delay Time and Sync (Binary, Ternary, Dotted)	Changes the length of the delay, from 2 ms. to 2 seconds (2000 ms.), or if Sync is lit, synchronizes the delays according to tempo from 1/32 notes to 8 (every 8 measures), as long as the total delay doesn't exceed 2 seconds. For a description of the Sync Binary, Triplets, and Dotted options, see LFO 2 and 3 controls [p.47] . <i>Appears as a Mod Destination in the Advanced LFOs, Mod Mixer and Sequencer.</i>
Feedback	Adjusts how many times the delay will repeat.
HP Freq	High pass filter: Higher values reduce the bottom end below the pass frequency with each echo. Range 20 Hz to 10 kHz.
LP Freq	Low pass filter: Higher values reduce the high end above the pass frequency with each echo. Range 250 Hz to 20 kHz.
Width	Higher values increase the distance between the left and right repetitions of the echoes.
Ping-Pong	Toggles between Stereo and Ping-Pong (alternating left/right echoes with exact rhythmic spacing).
Dry/Wet	Controls the balance between the input signal and the effected signal.

8.4.4.3. Chorus



A Chorus delays the signal, then uses an internal low-frequency oscillator (LFO) to vary the playback speed of the delay, throwing the delayed signal out-of-tune with the input, like vocal doubling. The amount of change in pitch depends both on the depth of the delay range being scanned, and the speed and waveform of the modulating LFO. The effect is similar to a flanger, except that since the delay time of a chorus is longer than that of a flanger, the delayed signal is out-of-tune instead of comb filtering. This results in a more-subtle but still very useful effect.

i: The Chorus effect is similar in results to the [Unison detune \[p.19\]](#) feature of the JUP-8 V4, but it doesn't consume polyphony.

Control	Description
Voices	Selects the number of delay lines the chorus will use (from 1 to 3), with a different starting phase for each voice.
Delay	Sets the amount of delay applied to the input signal, from 0.6 to 20 milliseconds.
Depth	Controls the depth of the chorus (e.g., how far above and below the incoming pitch) by adjusting the range of time that will be scanned, from 0 to 10 milliseconds.
LFO Shape	Toggles modulation LFO between sine and triangle waveforms.
Frequency	Adjusts the speed of the chorus (the frequency of the scanning LFO) from 0.1 to 5 Hz.
Feedback	Controls how much of the output is fed back into the input, creating more harmonics. <i>Appears as a Mod Destination in the Modulations section and Mod Sequencer.</i>
Stereo	Switches between mono and stereo output.
Dry/Wet	Controls the balance between the input signal and the effected signal. Note: Chorusing is most effective when there is a mixture of wet and dry signal, so there are beat frequencies between them.

i: There is a crucial relationship between Depth and Frequency. If Depth is high but Frequency is low, the effect is of a subtle de-tuning. As Frequency is increased, the result is more like a vibrato where the LFO frequency is obvious.

8.4.4.4. Flanger



Flanging works by mixing two nearly-identical signals together, with one signal delayed by a small and gradually changing period. This produces a swept “comb filter” effect as the delayed signal adds and subtracts from the original due to phase cancellation at multiple frequencies simultaneously.

Control	Description
Stereo	Switches the flanger output between mono and stereo.
LP Freq	Low Pass Filter, range 1 kHz to 20 kHz. Use this to reduce the range of high-frequency content that will enter the flanger effect. Double-click to set to the default of 13 kHz.
HP Freq	High Pass Filter, range 30 Hz to 800 Hz. This rolls off low-frequency content that the flanger effect will receive. Double-click to set to the default of 100 Hz.
Shape	Toggles the modulation LFO between sine and triangle waveforms.
Polarity	Changes flanger feedback to subtractive (negative) rather than additive.
Feedback	Adds feedback for a harsher or ‘ringing’ sound, similar to a resonant filter. Maximum is 99% to avoid runaway feedback.
Min Delay	Sets the base delay frequency, which changes the spacing and frequency of the resulting comb filter.
Depth	Sets the range of delay time that will be scanned around the base frequency. When Depth is 0, the comb filter stays at a fixed position set by the Min Delay control.
Frequency	Controls the sweep speed of the flange effect from 0.010 to 10 Hz. <i>Appears as a Mod Destination in the Advanced Modulations window and Mod Sequencer.</i>
Dry/Wet	Controls the balance between the input signal and the effected signal. Note: flanging characteristics are strongest when there is a mix of dry and wet signals.

8.4.4.5. Phaser



A phaser uses a steep multipole filter whose frequency can be modulated by an LFO, sweeping across the spectrum of the input, causing that familiar “whooshing” sound. It is similar to flanging, but is filter and phase-based instead of time-based.

Control	Description
Sync (Binary, Ternary, Dotted)	If Sync is lit, it synchronizes the LFO Rate with master tempo clock in a range from 4 bars/cycle to 32 cycles/bar. For a description of the Sync Binary, Triplets, and Dotted options, see LFO 2 and 3 controls [p.47] .
LFO Wave	Selects one of six modulation waveforms: Sine, Triangle, Saw, Ramp, Square, or Sample & Hold.
Frequency	Sets the harmonic center for the modulation effect.
Feedback	Controls the amount of phaser resonance.
LFO Rate	Controls the speed of the phaser effect, from 0.100 to 5 Hz when Sync is not lit, and from 4 bars to 1/32 bars when Sync is lit. <i>Appears as a Mod Destination in the Advanced Modulations window and Mod Sequencer.</i>
LFO Amount	Determines the depth of the modulation effect. If depth is 0, the filter frequency stays in one position.
N Poles	Stands for Number of Poles. Determines the steepness of the filter frequency response from 2 (subtle) to 12 (extreme). (Each pole increases the angle by 6 dB per octave)
Stereo	Gradually changes the phaser from mono to stereo output.
Dry/Wet	Controls the balance between the input signal and the effected signal.

8.4.4.6. Overdrive



The Overdrive effect will add a certain "fuzziness", deliberately distorting the sound. The tone control will adjust the brightness of the output. This is modeled after a "solid-state" circuit being distorted.

Control	Description
Drive	Sets the overdrive amount. <i>Appears as a Mod Destination in the Advanced Modulations window and Mod Sequencer.</i>
Tone	Adjusts the high frequencies of the sound, smoothing it or adding a harsher edge.
Level	Use this to compensate for increased output gain caused by the other settings.
Dry/Wet	Controls the balance between the input signal and the effected signal.

8.4.4.7. Compressor



A compressor is an automatic level control. If a signal rises above a certain level (the threshold), the compressor lowers the signal output to compensate (at low Ratios) or won't let it rise at all (high Ratios, also called "limiting"). It is generally used to help maintain a consistent level of sound, though there are many other ways to use it.

For example, it can keep the attack transients of a sound from overloading the input of the next effect. It can also help a sound which would normally decay quickly to sustain longer.

The red **gain reduction meter** shows you how much the compressor is reducing the gain, if the input signal is greater than the threshold and the ratio is greater than 1:1.

Control	Description
Attack	Adjusts the speed with which the compression will be applied after the threshold is reached, from 0.01 to 1000 ms.
Release	Sets the release time of the compressor, from 1 to 2000 ms. This is the time it will take for the compressor to stop reducing the level after input signal is lower than threshold. <i>Appears as a Mod Destination in the Advanced Modulations window and Mod Sequencer.</i>
Threshold	Sets the level where compression will begin, from -80 dB to 0 dB.
Input Gain	Increases the level coming into the compressor (pre-threshold). To get gain reduction, you may either increase the Input Gain or lower the Threshold until you see reduction on the meter above.
Ratio	Determines the amount of compression to be applied once the threshold is reached. A setting of 4 means 4:1: if the input signal is 4 dB over, output will rise only 1 dB.
Output Gain	Use this to compensate for changes in volume if compression settings lower the volume too much.
Makeup	When on, automatically increases or decreases output level to compensate for Threshold setting.
Dry/Wet	Controls the balance between the input signal and the effected signal.



For most applications, a compressor should be in the 100% "Wet" setting, but some engineers find a mix of the original and compressed signal useful.

8.4.4.8. BitCrusher

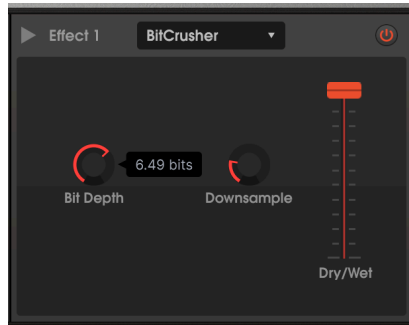

This is a digital distortion effect that operates by lowering the word length (bit depth) and downsampling the digital signal, introducing noise, aliasing, and dulling the frequency response. This is what happens when good digits go bad.

Parameter	Description
Bit Depth	Sets the number of bits from 16 (no effect) to 1.5, lowering the resolution and increasing noise.
Downsample	Sets the amount of downsampling from 1x (no effect) to 80x, lowering the bandwidth and increasing distortion and aliasing effects.

8.4.4.9. Multi Filter



In LP (Low pass filter) mode with a slope of 36 dB/octave and a fairly high resonance

This analog filter model inserts a filter with selectable slope and adjustable resonance into the FX chain. It can act in low pass, high pass, band pass, and two comb filter modes. Each pass filter is available in 12, 24, and 36 dB per octave slopes.

Parameter	Description
Mode	Select from 5 options, including LP (Low Pass), HP (High Pass), BP (BandPass), Comb FB and Comb FF by clicking on the name under the frequency chart.
Slope	12, 24, or 36 dB per octave: sets how steep the rolloffs will be for the pass filters. (Not present for Comb filters.)
Frequency	Sets the frequency of the filter. <i>Appears as a Mod Destination in the Advanced Modulations window and Mod Sequencer.</i>
Resonance	Emphasizes the cutoff frequency, or the peaks and depths of the comb filters.
Wet/Dry Amount	Controls the balance between the input signal and the effected signal. Note: if you want to use this as a pass filter in the FX chain, this effect should be 100% Wet (fader all the way to the top).

8.4.4.10. Parametric EQ

This is a five-band parametric equalizer. *Parametric* means that each band of the EQ can be adjusted in 3 different parameters: Gain, frequency, and Q (sometimes referred to as bandwidth).

- Two of the bands are *shelving* EQs, so called because their frequency chart looks like a shelf. The **LS** stands for Low Shelving: it raises or cuts all the frequencies on the low end by the same amount, like a conventional "bass" control. The **HS** stands for High Shelving: it raises or cuts all frequencies on the high end, like a conventional "treble" control.
- The other three bands are **Peak** filters. Each can be set to any frequency between 40 Hz and 20 kHz and can vary in width (Q) from several octaves to a very narrow notch filter.
- You can adjust the frequency and gain of any band by clicking and dragging on its icon in the frequency chart, or by clicking on the knobs. Q can only be adjusted by the knob.
- Select a band by clicking on its square below the knobs, or by clicking on its icon in the chart.

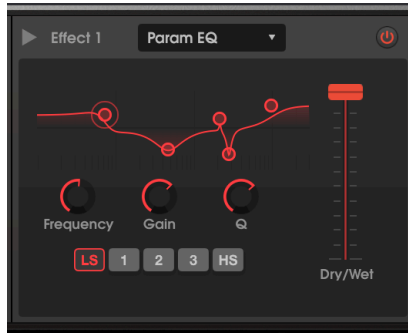

Low shelving is chosen with a slight boost and Q giving it a slight "bump" at the slope. Band 1 has a low, broad Q, bands 3 and 4 are almost notch filters with high Q, and High Shelving is boosted

Parameter	Description
Frequency	The LS (Low Shelving) filter is adjustable from 50 to 500 Hz, the Peak filters are adjustable from 40 Hz to 20 kHz, and the HS (High Shelving) filter is adjustable from 1 kHz to 10 kHz.
Gain	Adjustable from -15 to +15 dB. Double-click to set to the default value of 0 dB.
Frequency	Sets the frequency of the filter.
Q	Adjusts the quality of the filter from wide to narrow. The double-click default value is about an octave wide (1.23). For shelving filters, Q affects the shape of the curve above and below the frequency before it flattens out.
Wet/Dry Amount	Controls the balance between the input signal and the effected signal. Normally an EQ effect should be 100% Wet (fader all the way to the top).

8.4.4.11. Stereo Pan

This effect pans the signal back and forth from left to right in varying depths and speeds.

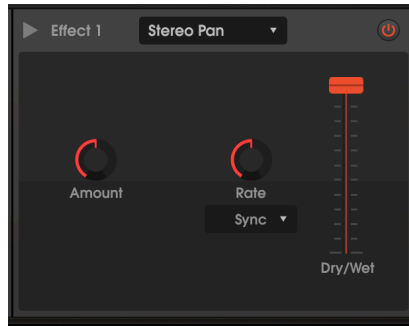

Parameter	Description
Amount	Determines the amount of swing from left to right. At low levels, the signal is close to the center; at maximum, it pans from hard left to hard right.
Rate	Controls the speed of stereo panning, in conjunction with the Rate Pulldown menu. <i>Appears as a Mod Destination in the Advanced Modulations window and Mod Sequencer.</i>
Rate Pulldown: Hertz, Sync Binary, Triplets, Dotted)	In Hertz mode, you can vary the speed of panning from 0.1 to 20 Hz. In any of the Sync modes you can vary the speed relative to the master tempo from 8/1 to 1/32.
Dry/Wet	Balances the output between unpanned and panned signal. To get the full stereo effect when the Amount is at maximum, this fader should be up full (100% wet mix).



When Stereo Pan is fed by a Chorus, the combined effect can be similar to that of a Leslie speaker.

8.4.5. Modulation Mixer FX Parameters

When you select an effect for any of the slots, its name will appear in the list of Mod Mixer Destinations. For example, if you select Reverb as FX 1, the Mod Mixer Destinations will list "Reverb 1 Dry/Wet" and "Reverb 1 Decay" as destinations. The parameters for each effect are listed below:

Effect	Parameter
Reverb	Decay time
Delay	Delay time
Chorus	Chorus feedback
Flanger	Frequency
Phaser	Rate
Overdrive	Drive
Compressor	Release time
BitCrusher	Depth
Multimode Filter	Cutoff
Parametric EQ	-- (none)
Stereo Pan	Rate

9. DISPERSION



The DISPERSION section with the trimpot "cover" open. Dispersion preset 1 shows some pitch variance, and low levels of pulse width, envelope, VCF cutoff and resonance, and modulation dispersion

Sometimes minor imperfections in an instrument give it soul and character. The strings of a piano are never perfectly in tune, and the way each hammer strikes its own string is unique.

So it was with analog synthesizers. Analog components have variable tolerances, are subject to aging, and react to ambient temperature changes. So they had to be recalibrated from time to time to tune their oscillators, filters, envelopes and other parameters by "tweaking" small trimpots (potentiometers) on the circuit card, or, later, by automatic calibration circuits.

In a keyboard like the Roland Jupiter 8 (so-called because it had 8 voices), it may look like you have two oscillators, two envelopes, and one filter; but actually there were 16 oscillators and envelopes and 8 VCAs and filters. Theoretically, the eight voices should be identical to each other in tuning and other parameters; in reality they had differences from each other.

Virtual instruments are digital, which can be a good thing. They don't age, drift out of tune or fall out of calibration. But this also suppresses the small imperfections that sculpt the character of the instrument.

So to fully capture the analog nature of the Jupiter 8, Arturia engineers added the **Dispersion** controls to the JUP-8 V4 emulation. These allow you to select exactly how "analog" you want a patch to be. You may not notice the effect right away; it can be subtle, but it can also bring life into your sounds and make the instrument sound organic.

9.1. Dispersion modes: 1, 2, 3 and Custom

There are four green keys that select the dispersion mode. The numbered modes are factory presets emulating a condition of the synthesizer.

Dispersion mode is saved with every preset; if you make your own Custom setting for a preset, that will be saved with that preset only and will not be applied to other presets that have their own Custom mode.

The three preset dispersion modes are arranged basically in increasing amounts of dispersion from left to right.

- **Mode 1** is shown in the picture at the beginning of this section. It is the most subtle of the bunch, roughly equivalent to the slight drift just after calibration. The pitch of successive voices will be only slightly different from each other (in a range of about $\pm 5/100$ ths of a semitone, 5 cents), and the other settings are very moderate.
- **Mode 2** turns each of the trimpots to about the midway point, introducing more dispersion to the voices. The pitch of the voices varies in a range of about $\pm 1/10$ of a semitone (10 cents).
- **Mode 3** introduces more timbre differences between voices, with PW and RESO set to maximum, CUTOFF at $3/4$, and a pitch range of about ± 15 cents, enough to be noticeable but not offensive.
- **Custom** mode turns on the moment you adjust a trimpot. You can tweak to your heart's delight; your Dispersion settings will be saved with everything else when you save the preset, and is unique to that preset.

 **To remove all dispersion effects**, make a Custom setting with all the trimpots turned full counter-clockwise. The JUP-8 V4 will play in perfect digital tuning and all pulse widths, envelope and filter settings, and modulations will be uniform between notes.

9.2. Dispersion trimpots

There are six different controls that adjust how much dispersion will be applied to parameters of the JUP-8 V4.

- **To view the trimpot settings** click on the grey area between the Dispersion buttons and the keyboard.
- **To change a trimpot** click and drag just as you would any other control. The mode will automatically switch to Custom.
- **To hide the trimpot settings** click between any trimpots.

The trimpots have a range from 0.00 (no effect) to 1.00 (full dispersion) and have these effects:

Pitch controls how much variation from concert pitch successive voices will have. At 0.00 each voice will be in tune. At 1.00, keys may vary from their intended pitch by as much as ± 50 cents (half a semitone). Time to break out the little screwdriver!

PW (Pulse Width) varies the pulse width of a rectangle, square and triangle wave on different voices. You won't hear the effect of this dispersion unless a VCO WAVE switch is in the rectangle, square, or triangle position.

ENV (Envelopes) introduces discrepancies between each voice's envelope times.

CUTOFF varies the setting of the VCF CUT control on different voices. To hear the effect, the VCF CUT control on the top panel cannot be wide open. Higher settings of RES make the effect more obvious.

RESO (Resonance) introduces differences to the VCF RES setting on different voices. This dispersion effect is most audible on presets with relatively high RES settings.

MOD varies the modulation amounts from the VCO MODULATOR sources (LFO 1 and ENV-1 to VCO frequency, LFO to PWM) and to VCF CUT from LFO 1, Envelopes, and BEND VCF, introducing subtle variations in modulation amounts from the top panel controls. This does not affect modulations coming from the Advanced Panel.



When using the Arpeggiator, the voice allocation cycles from step to step, accentuating the differences caused by different Dispersion settings between voices. This can create interesting and natural arpeggios.

10. THE PRESET BROWSER

The Preset Browser is where you can search through all of the presets. Open the Preset Browser by clicking the library symbol on the toolbar. To close the Preset Browser and return to the main screen, click the "X" that appears in the Toolbar.

To narrow down your choice and help you find the sounds you want, you can enter keywords in the search bar. You can narrow your search further by clicking on one of the drop down menus under the search bar which lists categories and has tags to point you in the right direction. You can cancel the list by pressing "clear all".

The results of your search are listed in the middle column. You can easily audition any displayed preset by clicking on it and playing a connected MIDI keyboard. You can sort the list results in various ways by clicking the column headers directly above the preset names. If you're feeling spontaneous, click the Shuffle button at the top right to randomly select one preset from the results list. This is a fun and quick way to audition sounds without having to step through the list one-by-one.

Details about the currently selected preset are listed in the right column.

Options for saving or deleting patches are listed at the bottom of this column.

i: Factory presets cannot be modified, deleted or overwritten. Only "User" (user generated) presets can be deleted, overwritten or saved under a different name. This is done by using the "Delete" "Save" or "Save As" buttons at the bottom of the right column. If you have modified a Factory preset and would like to save it, you must save your modified preset under a different name (only the "Save As" option appears in this case since you cannot delete or overwrite factory sounds).

10.1. Browse Presets With MIDI Controller

This option allows you to browse presets using the Browse knobs on Arturia MIDI Controllers. This makes it incredibly efficient to quickly audition sounds without having to reach for the mouse. To use this feature, select your Arturia controller from the menu and its Browse knob will be automatically mapped to preset browsing.

10.2. Playlists

In the lower left corner of the Preset Browser window is a feature titled Playlists. This is used to collect presets into collection groups, such as a set list for a particular performance or a set of presets related to a particular studio project.

10.2.1. Add a playlist

To create a playlist, click the **+ New Playlist** button. Give the playlist a name and it will appear in the Playlists menu. To rename the playlist at any time, double click on the name.

10.2.2. Add a preset to the playlist

You can use the Search window to locate the presets you want to add to your playlist. Once you have found the right preset, click and drag it onto the playlist name on the left.

You will see a message which tells you that the new preset will be duplicated. Jup-8 V4 will create a copy of the preset so that you can modify settings in the playlist presets without impacting the original preset it is based on, and vice versa.

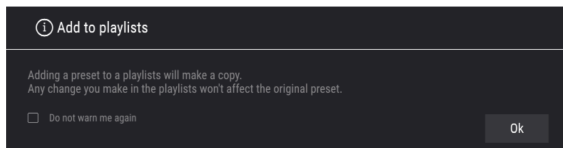

To view the contents of a playlist, click on the playlist name.

10.2.3. Re-order the presets in the playlist

Presets may be reorganized within a playlist. For example, to move a preset from slot 3 to slot 1, drag and drop the preset to the desired location.

This will move the preset into the new location.

10.2.4. Remove a preset from the playlist

To remove a preset from a playlist, right click on the preset name.

10.2.5. Delete a playlist

To delete a playlist, right click on the playlist name.

11. SOFTWARE LICENSE AGREEMENT

In consideration of payment of the Licensee fee, which is a portion of the price you paid, Arturia, as Licensor, grants to you (hereinafter termed "Licensee") a nonexclusive right to use this copy of the SOFTWARE.

All intellectual property rights in the software belong to Arturia SA (hereinafter: "Arturia"). Arturia permits you only to copy, download, install and use the software in accordance with the terms and conditions of this Agreement.

The product contains product activation for protection against unlawful copying. The OEM software can be used only following registration.

Internet access is required for the activation process. The terms and conditions for use of the software by you, the end-user, appear below. By installing the software on your computer you agree to these terms and conditions. Please read the following text carefully in its entirety. If you do not approve these terms and conditions, you must not install this software. In this event give the product back to where you have purchased it (including all written material, the complete undamaged packing as well as the enclosed hardware) immediately but at the latest within 30 days in return for a refund of the purchase price.

1. Software Ownership Arturia shall retain full and complete title to the SOFTWARE recorded on the enclosed disks and all subsequent copies of the SOFTWARE, regardless of the media or form on or in which the original disks or copies may exist. The License is not a sale of the original SOFTWARE.

2. Grant of License Arturia grants you a non-exclusive license for the use of the software according to the terms and conditions of this Agreement. You may not lease, loan or sublicense the software. The use of the software within a network is illegal where there is the possibility of a contemporaneous multiple use of the program.

You are entitled to prepare a backup copy of the software which will not be used for purposes other than storage purposes.

You shall have no further right or interest to use the software other than the limited rights as specified in this Agreement. Arturia reserves all rights not expressly granted.

3. Activation of the Software Arturia may use a compulsory activation of the software and a compulsory registration of the OEM software for license control to protect the software against unlawful copying. If you do not accept the terms and conditions of this Agreement, the software will not work.

In such a case the product including the software may only be returned within 30 days following acquisition of the product. Upon return a claim according to § 11 shall not apply.

4. Support, Upgrades and Updates after Product Registration You can only receive support, upgrades and updates following the personal product registration. Support is provided only for the current version and for the previous version during one year after publication of the new version. Arturia can modify and partly or completely adjust the nature of the support (hotline, forum on the website etc.), upgrades and updates at any time.

The product registration is possible during the activation process or at any time later through the Internet. In such a process you are asked to agree to the storage and use of your personal data (name, address, contact, email-address, and license data) for the purposes specified above. Arturia may also forward these data to engaged third parties, in particular distributors, for support purposes and for the verification of the upgrade or update right.

5. No Unbundling The software usually contains a variety of different files which in its configuration ensure the complete functionality of the software. The software may be used as one product only. It is not required that you use or install all components of the software. You must not arrange components of the software in a new way and develop a modified version of the software or a new product as a result. The configuration of the software may not be modified for the purpose of distribution, assignment or resale.

6. Assignment of Rights You may assign all your rights to use the software to another person subject to the conditions that (a) you assign to this other person (i) this Agreement and (ii) the software or hardware provided with the software, packed or preinstalled thereon, including all copies, upgrades, updates, backup copies and previous versions, which granted a right to an update or upgrade on this software, (b) you do not retain upgrades, updates, backup copies and previous versions of this software and (c) the recipient accepts the terms and conditions of this Agreement as well as other regulations pursuant to which you acquired a valid software license.

A return of the product due to a failure to accept the terms and conditions of this Agreement, e.g. the product activation, shall not be possible following the assignment of rights.

7. Upgrades and Updates You must have a valid license for the previous or more inferior version of the software in order to be allowed to use an upgrade or update for the software. Upon transferring this previous or more inferior version of the software to third parties the right to use the upgrade or update of the software shall expire.

The acquisition of an upgrade or update does not in itself confer any right to use the software.

The right of support for the previous or inferior version of the software expires upon the installation of an upgrade or update.

8. Limited Warranty Arturia warrants that the disks on which the software is furnished is free from defects in materials and workmanship under normal use for a period of thirty (30) days from the date of purchase. Your receipt shall be evidence of the date of purchase. Any implied warranties on the software are limited to thirty (30) days from the date of purchase. Some states do not allow limitations on duration of an implied warranty, so the above limitation may not apply to you. All programs and accompanying materials are provided "as is" without warranty of any kind. The complete risk as to the quality and performance of the programs is with you. Should the program prove defective, you assume the entire cost of all necessary servicing, repair or correction.

9. Remedies Arturia's entire liability and your exclusive remedy shall be at Arturia's option either (a) return of the purchase price or (b) replacement of the disk that does not meet the Limited Warranty and which is returned to Arturia with a copy of your receipt. This limited Warranty is void if failure of the software has resulted from accident, abuse, modification, or misapplication. Any replacement software will be warranted for the remainder of the original warranty period or thirty (30) days, whichever is longer.

10. No other Warranties The above warranties are in lieu of all other warranties, expressed or implied, including but not limited to, the implied warranties of merchantability and fitness for a particular purpose. No oral or written information or advice given by Arturia, its dealers, distributors, agents or employees shall create a warranty or in any way increase the scope of this limited warranty.

11. No Liability for Consequential Damages Neither Arturia nor anyone else involved in the creation, production, or delivery of this product shall be liable for any direct, indirect, consequential, or incidental damages arising out of the use of, or inability to use this product (including without limitation, damages for loss of business profits, business interruption, loss of business information and the like) even if Arturia was previously advised of the possibility of such damages. Some states do not allow limitations on the length of an implied warranty or the exclusion or limitation of incidental or consequential damages, so the above limitation or exclusions may not apply to you. This warranty gives you specific legal rights, and you may also have other rights which vary from state to state.