

escape™

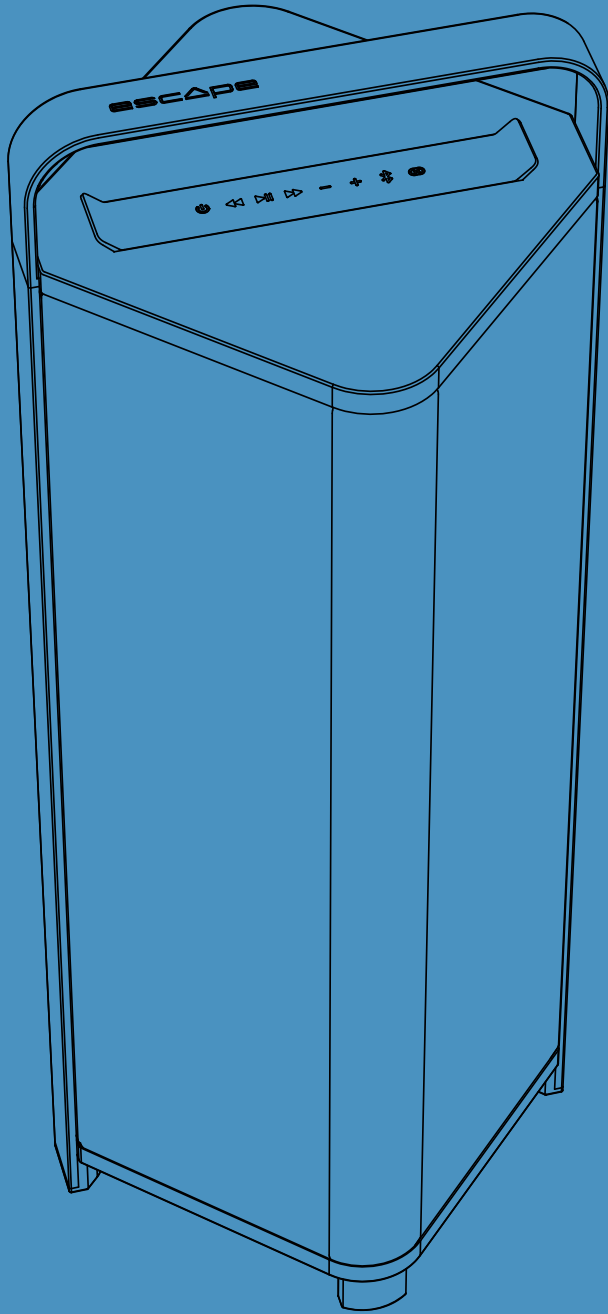

P9

USER GUIDE

CONTENTS

1	Electrical safety advisory	4
	■ Important safety information	4
	■ LiFeP04 batteries safety instructions	5
2	USA and Canada compliance	6
	■ FCC and Industry Canada	6
	■ European Union.....	7
	■ Warnings.....	7
	■ EU WEEE.....	7
3	Introduction	8
4	Items included	8
5	Getting started	9
	■ Keypad control buttons	9
	■ Charging the internal battery.....	9
	■ Power LED - battery status indicator	10
	■ Turning the Escape™ P9 on and off.....	11
	■ Track controls	11
	■ Volume control	11
6	Bluetooth® pairing	11
	■ Connecting an Android™ and Apple® device	11
	■ Clearing the Bluetooth® memory.....	12
	■ Disconnecting an Apple® (iOS®) device	12
	■ Disconnecting an Android™ device.....	12
	■ Bluetooth® Twin mode.....	13
	■ Bluetooth® Twin mode.....	14
	■ Bluetooth® Twin mode.....	15

7	Connecting external audio sources.....	16
	■ Priority	16
	■ Aux 1: universal 3.5mm auxiliary input	16
	■ USB flash drive	17
	■ Aux 2: universal 3.5mm auxiliary input inside the compartment located underneath the keypad.....	18
8	Additional features	18
	■ Stand-by mode	18
	■ Locking the keypad.....	19
	■ Anti-theft anchor point	19
	■ Replacing the battery.....	20
9	App.....	21
10	Frequently Asked Questions	21
11	Specifications	21
	■ Full-range drivers.....	21
	■ Amplifier.....	21
	■ Dual 24-bit DSP processor	22
	■ Subwoofer	22
	■ Rechargeable lithium iron phosphate battery.....	22
	■ Bluetooth®	22
	■ Dimensions	22
	■ Weight.....	22
	■ Additional audio inputs.....	22
	■ Design.....	22
12	Cleaning instructions and fabric care.....	23
13	Warranty	23
	■ Limited warranty for the unit	23
	■ Limited warranty for the battery.....	23
	■ Returning a device for repairs	23
14	Copyright information.....	24
	■ Patents	24
	■ Directives.....	24
	■ Declaration of conformity.....	24
	■ Brand information	25
	■ Images	25

User guide





1 Electrical safety advisory

1.1 Important safety information

Read all safety information in this document and in the quick-start guide before using this product.

- Read and keep these instructions so that you can consult them if necessary.
- Heed all warnings and follow all instructions.
- Do not submerge the unit in water or other liquids. The product is weather-resistant but not water-resistant. Place the speaker inside if you are not using it for a long period of time.
- Clean the unit as recommended by the manufacturer. For more details, see Cleaning instructions and fabric care on page 23.
- Do not block any ventilation openings (for example on the underside of the product). Use in accordance with the manufacturer's instructions.
- Do not install near any heat sources such as radiators, heating registers, stoves, or other devices that produce heat. Do not place open flames, such as lighted candles, on or near the product.
- Do not defeat the safety purpose of the polarized or grounding-type plug. A polarized plug has two blades with one wider than the other. A grounding type plug has two blades and a third grounding prong. The wide blade or the third prong is provided for your safety. If the provided plug does not fit into your power outlet, consult an electrician to replace the obsolete outlet.
- Only use attachments and/or accessories specified by the manufacturer.
- Only let qualified service personnel do repairs. Repairs are required when the unit or parts of it are damaged, such as power-supply cord or plug, an object has fallen into the unit, the unit does not function normally, liquid has been spilled inside the unit, or if the unit has been dropped.

- To stop using electricity to charge the unit, disconnect the unit's power cord from the power outlet. To reconnect, plug the unit's power cord into the power outlet following all safety instructions and guidelines.
- The unit contains magnetic material. Contact your physician if you have questions on whether this might affect possible implanted medical devices.
- Do not make unauthorized alterations to the unit.
- Polyester and plastic bags can be dangerous. To avoid danger of suffocation, keep the unit's packaging away from babies and children.
- Be careful when placing the Escape™ P9 outdoors and directly exposed to sunlight. The aluminum handle absorbs and disperses heat. Make sure to take the necessary precautions to prevent injuries and dangerous situations.

	<p>To reduce the risk of electric shock, do not remove the cover (or bottom section). Leave repairs to qualified service personnel.</p>
	<p>Dispose of the used battery according to the instructions of the battery manufacturer and applicable environmental guidelines. Do not open, puncture or burn the battery, or expose it to conducting materials, moisture, liquid, fire or heat above 54°C or 130°F.</p>
	<p>To help prevent tip-over:</p> <ul style="list-style-type: none"> • Always place the unit on a firm, flat and level surface. • Never allow children to climb or hang on the unit. • Do not put any heavy objects on top of the unit. • Use of tip-over restrains may only reduce, but not eliminate, the risk of tip-over.
	<p>Use only a cart, stand, tripod, bracket, or table specified by the manufacturer or sold with the apparatus. When a cart is used, use caution when moving the cart/apparatus combination to avoid injury from tip-over.</p>

1.2 LiFePO4 batteries safety instructions

To prevent the battery from leaking, heating up and exploding, please pay attention to the following precautions:

- Do not immerse the core in water.
- Do not use or store the battery near a heat source (such as fire, heater, etc.).
- Do not throw the battery into a fire or heater.

- Do not reverse the positive and negative terminals.
- Do not connect the positive and negative terminals directly to metal objects.
- Do not connect the electrode directly to the power socket.
- Do not transport and store the battery with metal objects such as necklaces or hairpins.
- Do not throw or step on the battery.
- Do not pierce the battery with a nail or other sharp objects.
- Do not use or store the battery in high temperatures (for example, strong direct sunlight or a vehicle in extremely hot conditions).
- If the battery terminals get dirty, clean them with a dry cloth before use.
- Only use the built-in charger of the Escape™ P9 to charge the battery.
- If the battery leaks and the electrolyte gets into your eyes, do not rub them, instead, thoroughly rinse the eyes with clean running water for at least 15 minutes, and immediately seek medical attention to avoid eyes injury.
- If the battery gives off an odor, generates heat, becomes discolored or deformed, or in any way appears abnormal during use, recharging or storage, immediately remove it from the device and dispose of it.
- If the battery's useful life expires, wrap the fully discharged battery in insulating tape and put the battery in the specialized recycle bin.

2 USA and Canada compliance

2.1 FCC and Industry Canada

This device complies with part 15 of the FCC rules and Industry Canada ICES-003. Operation is subject to the following two conditions: (1) this device may not cause harmful interference, and (2) this device must accept any interference received, including interference that may cause undesired operation.

Compliance of this equipment is confirmed by the following label that is placed on the equipment:



Important: Any changes or modifications not expressly approved by the party responsible for compliance could void the user's authority to operate this equipment.

Le présent appareil est conforme aux CNR d'Industrie Canada applicables aux appareils radio exempts de licence. L'exploitation est autorisée aux deux conditions suivantes : (1) l'appareil ne doit pas produire de brouillage, et (2) l'utilisateur de l'appareil doit accepter tout brouillage radioélectrique subi, même si le brouillage est susceptible d'en compromettre le fonctionnement.

Important: Tous les changements ou modifications pas expressément approuvés par la partie responsable de la conformité ont pu vider l'autorité de l'utilisateur pour actionner cet équipement.

2.2 European Union

Escape BV hereby declares that this product is in compliance with the essential requirements and other relevant provisions of Directive 2014/53/EU and all other applicable EU directive requirements.



2.3 Warnings



- The lightning flash with arrowhead symbol, within an equilateral triangle, is intended to alert the user to the presence of uninsulated dangerous voltage within the product's enclosure that may be of sufficient magnitude to constitute a risk of electric shock to persons.
- The exclamation point within an equilateral triangle is intended to alert the user to the presence of important operating and maintenance (servicing) instructions in the literature accompanying the appliance.
- Ce symbole représentant un éclair à l'intérieur d'un triangle équilatéral, a pour but d'avertir l'utilisateur de la présence d'une tension dangereuse non isolée dans le corps de l'appareil pouvant être suffisante pour constituer un risque de choc électrique.
- Le point d'exclamation dans un triangle équilatéral est destiné à alerter l'utilisateur de la présence d'instructions importantes de maintenance (entretien) dans la documentation accompagnant l'appareil.

2.4 EU WEEE





In accordance with the European Union WEEE (Waste Electrical and Electronic Equipment) directive effective August 13, 2005, we would like to notify you that this product may contain regulated materials which upon disposal, according to the WEEE directive, require special reuse and recycling processing. When disposing of packaging and other related shipping materials we encourage you to recycle these items through the normal channels.

Escape™ P9 battery meets the UN38.3 regulations.

3 Introduction

Thank you for choosing the Escape™ P9 portable loudspeaker. It will transform your outdoor space into one of the most popular places in your home. Every aspect of its design and development has been studied carefully to find better ways of engineering and to build a product that results in an incredible audio experience.

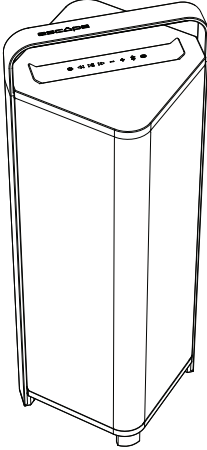





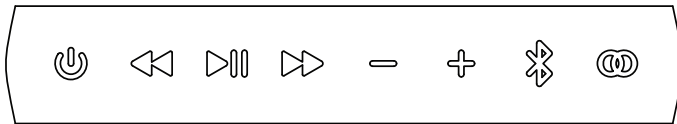

4 Items included

Item	Image
Escape™ P9	
Country-specific right-angle AC power cord: <ul style="list-style-type: none">• length: 1.5 meters (5 feet)	
3.5mm stereo jack cable: <ul style="list-style-type: none">• length: 50cm (20 inch)	

5 Getting started

5.1 Keypad control buttons



Control button	Function
 Power	Turn the Escape™ P9 on and off
 Previous track	Play the previous song
 Play/pause	Start or pause a song
 Next track	Play the next song
 Volume down	Decrease the volume
 Volume up	Increase the volume
 Bluetooth®	Connect a device using Bluetooth®
 Twin mode	Connect a second Escape™ P9 using Twin mode

5.2 Charging the internal battery

A complete charging cycle takes between two and three hours. You can use the Escape™ P9 during the charging process.

 Never leave the unit unattended while charging.

The built-in battery is partially charged in the factory for the purpose of testing. Before using the Escape™ P9 for the first time, you have to completely charge the internal battery.

The battery will slowly discharge if:

- it is not connected to the AC power
- it is not used for several weeks

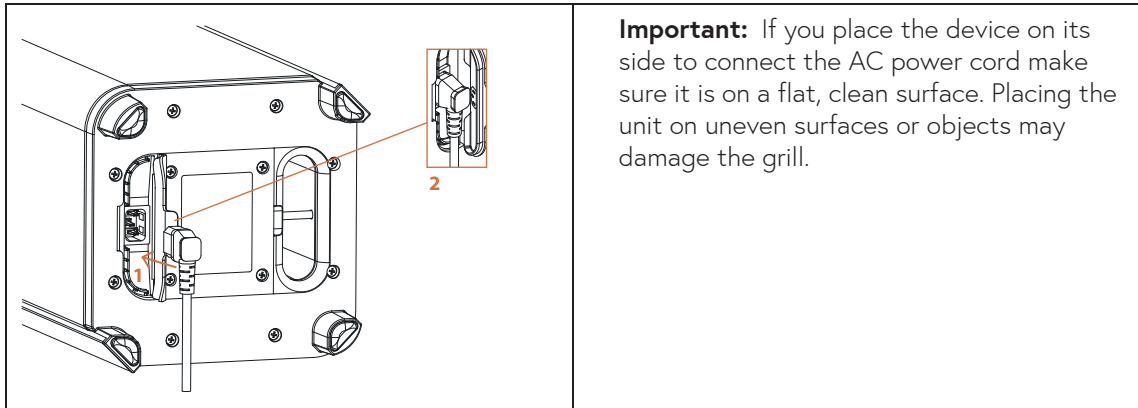

1. Open the protective cover from the AC power socket located at the bottom of the unit.
2. Connect the right-angle AC power cord to the three-prong outlet and insert the power cord plug into an AC outlet.
The power LED light will be red, indicating that the unit is charging. The battery is fully charged when the red LED is off.
3. Remove the right-angle AC power cord from the three-prong outlet and close the protective cover.

5.3 Power LED - battery status indicator

 The power LED light indicates the status of the internal battery.

LED appearance	Battery status
flashing red for 3 seconds and white for 0.5 seconds	The battery charge has reached approximately 20%. The unit is not connected to a power outlet and the battery needs to be charged.
solid red	The unit is connected to a power outlet and is charging.
white	The battery is fully charged.

LED appearance	Battery status
rapidly flashing red for 10 seconds	Battery error, for example when the power cable is connected to a power outlet but no battery has been installed.

5.4 Turning the Escape™ P9 on and off

1. Press and hold down the power button on the keypad for one second.
The power LED will light up and turn green. After 3 seconds, all keypad LEDs will turn white.
2. To turn the unit off, shortly press the power button again.

5.5 Track controls

You can navigate through tracks, pause and play using:

- the Escape™ P9 keypad control buttons
- the music app of your choice
- the Escape® Remote app*

*** Important !**
For the Remote app to work properly, the P9 MCU firmware must be version V3.19 or higher. More information can be found on the Escape website.

5.6 Volume control

You can increase or decrease the volume using:

- the Escape™ P9 keypad control buttons
- the music app of your choice
- the volume buttons on your device (in Bluetooth® mode only)
- the Escape® Remote app*

*** Important !**
For the Remote app to work properly, the P9 MCU firmware must be version V3.19 or higher. More information can be found on the Escape website.

6 Bluetooth® pairing

6.1 Connecting an Android™ and Apple® device

The Escape™ P9 memory can hold up to 8 different Bluetooth® devices. If a new device is paired after the maximum of 8 has been reached, the new one will replace the paired device with the oldest connection.

1. Press and hold down the power button on the keypad for one second.
The power LED will light up and turn green. After 3 seconds, all keypad LEDs will turn white.
2. To start the Bluetooth® pairing sequence, shortly press the Bluetooth® button.
The white LED will start flashing blue and white for 2 minutes.
3. Go to Settings on your Apple® (iOS®) or Android™ device and turn on Bluetooth®.

4. Select Escape™ P9 xxxx from the device list.

The xxxx represents the last 4 digits of the device name and is a unique combination that is also part of the serial number. You can find the complete serial number on the label next to the battery compartment, located on the bottom of the unit or on the shipping box.

 Do not select Escape™ P9 xxxx App on your device if listed. You will not be able to stream music if you do.

Once the connection has been established, the Bluetooth® symbol on the Escape™ P9 keypad will be solid blue.

5. Adjust the volume and navigate through tracks using your device or the buttons on the keypad.

Important: If the Escape™ P9 is not listed the first time please turn Bluetooth® off and on again on your mobile device.

6.2 Clearing the Bluetooth® memory

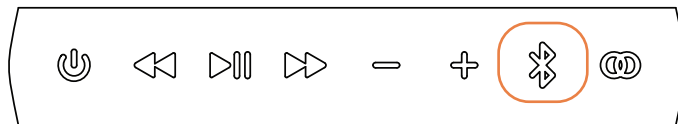

Press and hold down the Bluetooth® button on the Escape™ P9 keypad for 10 seconds until you hear a short confirmation tone.

All Bluetooth® devices stored in the memory will be erased.

6.3 Disconnecting an Apple® (iOS®) device

1. On your device, go to Settings > Bluetooth®.



2. In the My Device list, select the Escape™ P9 and tap the information symbol next to Connected.



3. Select either Disconnect or Forget This Device.

The Bluetooth® button on the keypad will start flashing blue and white. The device is no longer paired with the Escape™ P9.

6.4 Disconnecting an Android™ device

1. On your device, go to Settings > Connections.



2. Select Bluetooth®.
3. Select the Escape™ P9 in the list of paired devices.
4. Select Unpair.

The Bluetooth® button on the keypad will start flashing blue and white. The device is no longer paired with the Escape™ P9.

6.5 Bluetooth® Twin mode

Bluetooth® audio streaming has been limited to one speaker for many years. Now you can connect two Escape™ P9 speakers via Bluetooth® thanks to Twin mode.

Setting up Bluetooth® Twin mode



-  Make sure that both units are in close range during setup. The maximum range (5 to 10 meters) between the two speakers may vary depending on environmental factors and the presence or absence of shields and obstacles. During setup, make sure that the Bluetooth® symbol on the Escape™ P9 keypad is not green. No external audio input should be activated (Aux 1, Aux 2 or USB Flash Drive) on any of the two devices. All keypad LEDs must be white.

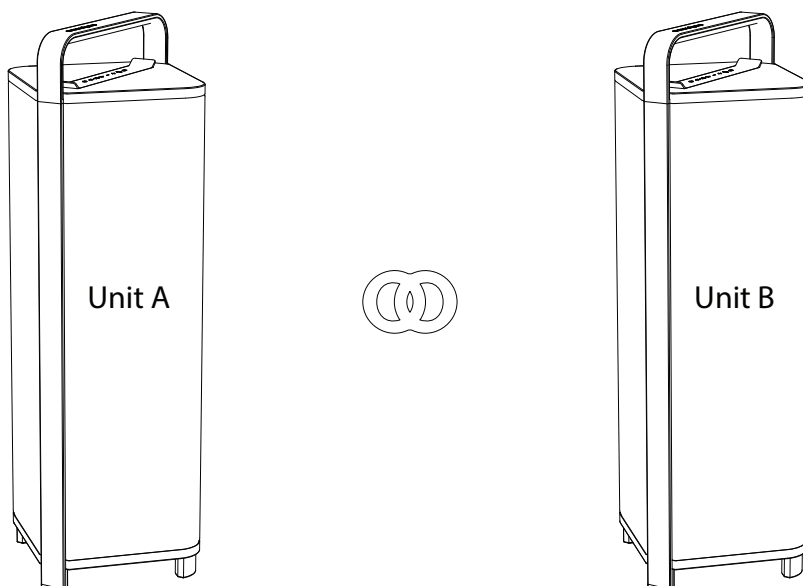

1. Turn on unit A and don't connect in Bluetooth® with your mobile device yet.

2. Turn on unit B.

All keypad LEDs must be white. If the Bluetooth® LED is blue, unit B is connected to another audio device than unit A. Disconnect the Bluetooth® link on this other device (see Disconnecting an Apple® (iOS®) device and Disconnecting an Android™ device) or reset the Bluetooth® memory on unit B (see Clearing the Bluetooth® memory). Make sure that unit A and unit B are in close proximity.

3. Press the Twin button on unit A twice within a very short time. The Twin button on unit A will be flashing blue and white every 2 seconds.

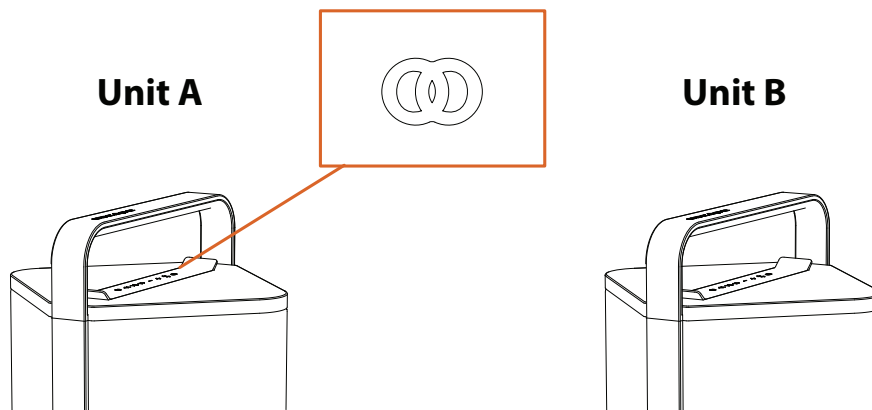

Unit A will act as the master device.

4. Press and hold the Twin button on unit B until you hear a confirmation tone.

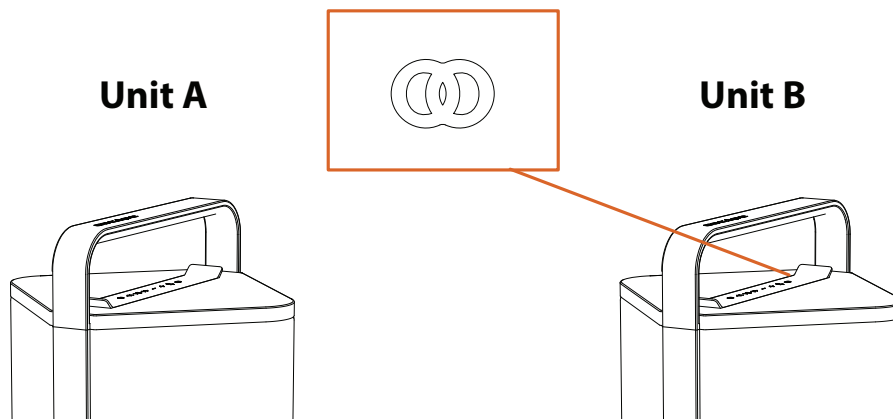

The pairing sequence between unit A and B will start. Both Twin buttons will start flashing blue and white every 2 seconds. Unit B will act as the Twin device.

The pairing sequence between unit A and B is successful when the Twin button LEDs on unit A and B are solid blue. Both units will now play the same stereo signal.

Note: If you accidentally activate the Twin mode, you must switch the P9 off and on again to end the activation or wait until the Twin mode search function automatically ends after 2 minutes.

5. Start the Bluetooth® audio pairing with the master speaker (Unit A) and your mobile audio device according to the instructions in section 6.1 point 2. Your music will now be played in stereo on both devices.

Tip: When unit A and B are turned off, turn on unit B first and then unit A for a smooth Twin pairing between the two devices and your Bluetooth® connection to unit A and your mobile device.

Keypad functions in Twin mode

When streaming music from an Apple® or Android™ device using Bluetooth®, the control buttons will work on both units. Volume up and down is synchronised and can be controlled on the device and on the Escape™ P9 keypad.

Turning off one of the speakers in Twin mode

The master device will remain active when the twin unit is turned off. Music will be paused first in Bluetooth® mode. When the master is turned off, the twin unit will no longer receive an audio signal.

External audio sources connected to the master speaker

Once the Twin mode has been set up, you can connect external audio sources to the master device, such as MP3 players or a USB flash drive. (For more details see external audio sources). External sources connected to the master will also play on the twin unit. External sources connected to the twin unit will play only on the twin.

Disabling the Twin mode between devices

Press and hold down the Twin and the volume down button simultaneously for 2-3 seconds on either master or twin speaker until you hear a short confirmation tone.

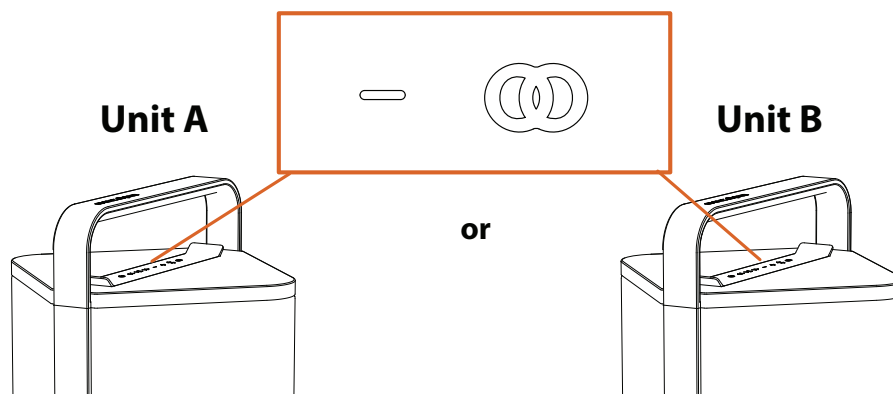

The blue LEDs on master and twin unit will turn white, indicating that Twin mode has been disabled on both units.

7 Connecting external audio sources

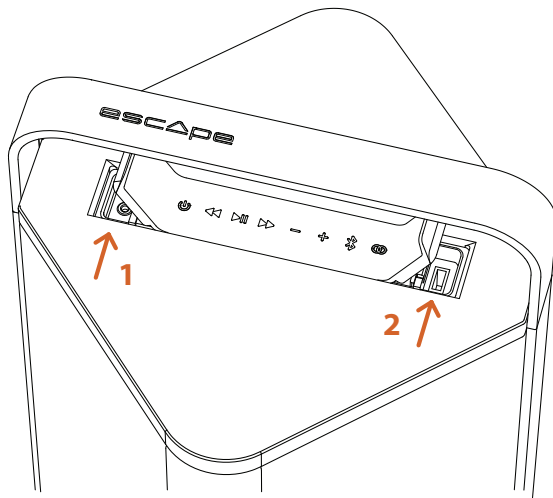

You can connect the Escape™ P9 to the following external audio sources:

1. Aux 1: universal 3.5mm auxiliary input
2. USB flash drive
3. Aux 2: universal 3.5mm auxiliary input inside the compartment located underneath the keypad

7.1 Priority

External audio sources are listed in order of priority. Lower priority audio sources will be deactivated when an audio input of a higher priority is activated. When one of the 3 external source inputs is activated, the Bluetooth® button on the Escape™ P9 keypad will change from solid blue to green.

Important: Please observe all warnings in this section that may void warranty.

7.2 Aux 1: universal 3.5mm auxiliary input

The 3.5mm aux input has the **highest priority**.

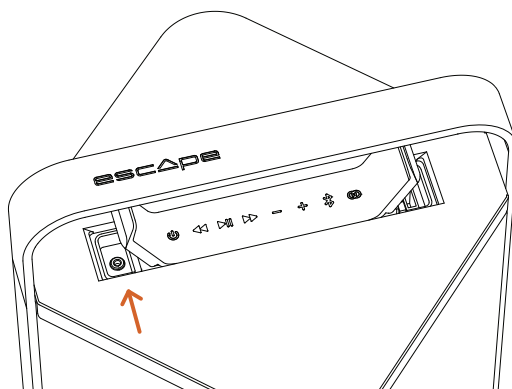

⚠ IMPORTANT WARRANTY INFORMATION: Do not expose the Escape™ P9 to rain or moisture while using the aux cable. Any damage to the aux input or other internal parts caused by water infiltration via the keypad lid is never covered by the warranty. In cases where the internal keypad has been exposed to water, it is important that the aux input is completely dry before a 3.5mm connector is inserted into it.

1. Lift up the left side of the keypad.
2. Connect any portable music player to the aux input using the 3.5mm stereo jack cable provided with the unit.

The volume controls on the external player and the keypad are no longer synchronized and the track control buttons will not function.

3. For optimum playback quality, set the volume of the external audio player to approximately 80%.
4. Adjust the desired output volume of the Escape™ P9 via the control buttons on the keypad.

7.3 USB flash drive

⚠ IMPORTANT WARRANTY INFORMATION: Make sure to use a USB Flash Drive small enough to be able to close the lid of the keypad again. The total height of the Flash Drive should not exceed 27mm. USB port damage and/or other circuitry caused by water infiltration via the keypad lid are never covered by the warranty. In cases where the keypad has been exposed to water, it is important that the USB port is completely dry before a USB cable or USB Flash Drive is inserted into the port.

- The Escape™ P9 can read audio files in MP3 and WMA formats. Files in DRM (Digital Rights Management) copyright protection or files downloaded from an online music store cannot be played.
- The USB input will not work as a playback input for Apple® devices.
- The input is in compliance with USB 2.0 (Full Speed).
- The USB flash drive input is **not a charging port**.

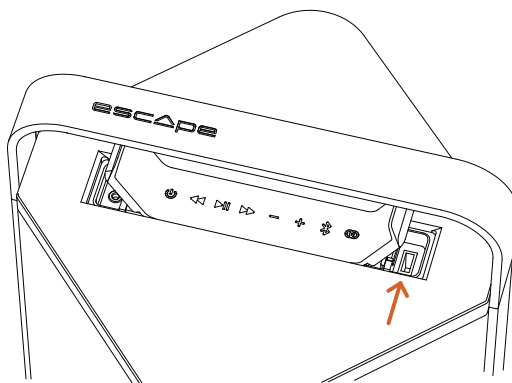

1. Lift up the right side of the keypad.
2. Plug a USB flash drive into the USB port.
3. Adjust the volume and navigate through tracks with the control buttons of the keypad.

7.4 Aux 2: universal 3.5mm auxiliary input inside the compartment located underneath the keypad

The Escape™ P9 has a weather-proof compartment underneath the keypad with a 3.5mm auxiliary input and USB power supply output to accommodate the M1 Air* receiver.

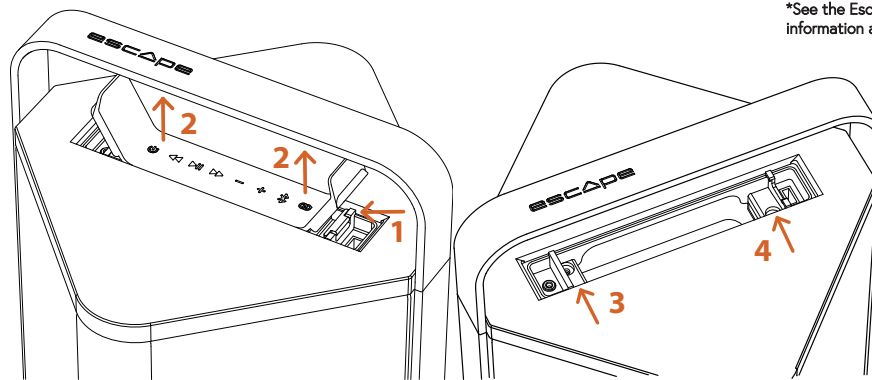

1. Open the keypad lid from the USB input and press against the snap-lock mechanism to release the keypad out of the compartment.
2. Remove the keypad from the top cover completely. Do not disconnect the keypad from the wire connector.
3. To re-install the keypad, slide it into the locking hook (3) next to the auxiliary input and gently press the keypad back into the snap-lock (4) mechanism.

8 Additional features

Note: To perform a factory reset, turn on the P9 and press the Play/pause button for 10 seconds until the unit switches off.

8.1 Stand-by mode

When the unit is connected to a mains outlet and switched on, it will automatically switch off after 20 minutes of inactivity (no audio signal). To turn the unit back on, press the power button on the keypad and hold it down for one second.

When the unit is not connected to a mains outlet and is using the internal battery, the Escape™ P9 will automatically switch off completely after 20 minutes of inactivity (no audio signal).

Important: At the lowest volume setting, the standby mode might be triggered while playing music with a small dynamic range.

Note: In a Twin mode configuration (see Bluetooth Twin mode), the Twin device will automatically switch off after 20 minutes and the master device after 40 minutes.

Auto turn-on in stand-by mode

When the unit is connected to a mains outlet and turned off in stand-by mode, the Escape™ P9 will automatically turn back on when it detects an audio signal.

When the unit is not connected to a mains outlet and turned off in stand-by mode, the Escape™ P9 can only be turned on via the keypad.

8.2 Locking the keypad

When the Escape™ P9 is used in a professional setting (bars, restaurants, hotels), it may be advisable to disable the buttons of the keypad.

1. To lock the keypad, press and hold down the previous track button ◀◀ for 5 seconds until you hear a confirmation tone.

The previous track button LED will blink white three times and stay white to confirm that the keypad is locked. The LED will blink three times every time one of the keypad buttons is pressed in keypad lock mode, except for the Twin button. (That button needs to be pressed twice shortly or once longer before the track button LED will blink white three times.)

2. To unlock the keypad, press and hold down the next track button ▶▶ for 5 seconds until you hear a confirmation tone.

Note: You will only hear a confirmation tone if the unit is in Bluetooth® mode.

3. Once the unit is turned off, the keypad will be unlocked automatically.

8.3 Anti-theft anchor point

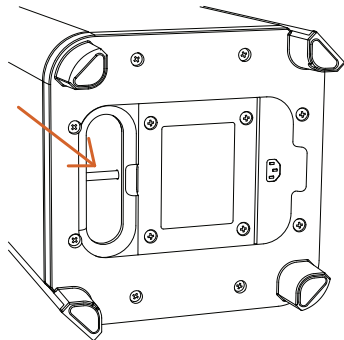

An anti-theft anchor point is located in the bass reflex port at the bottom to secure your unit with a steel cable.

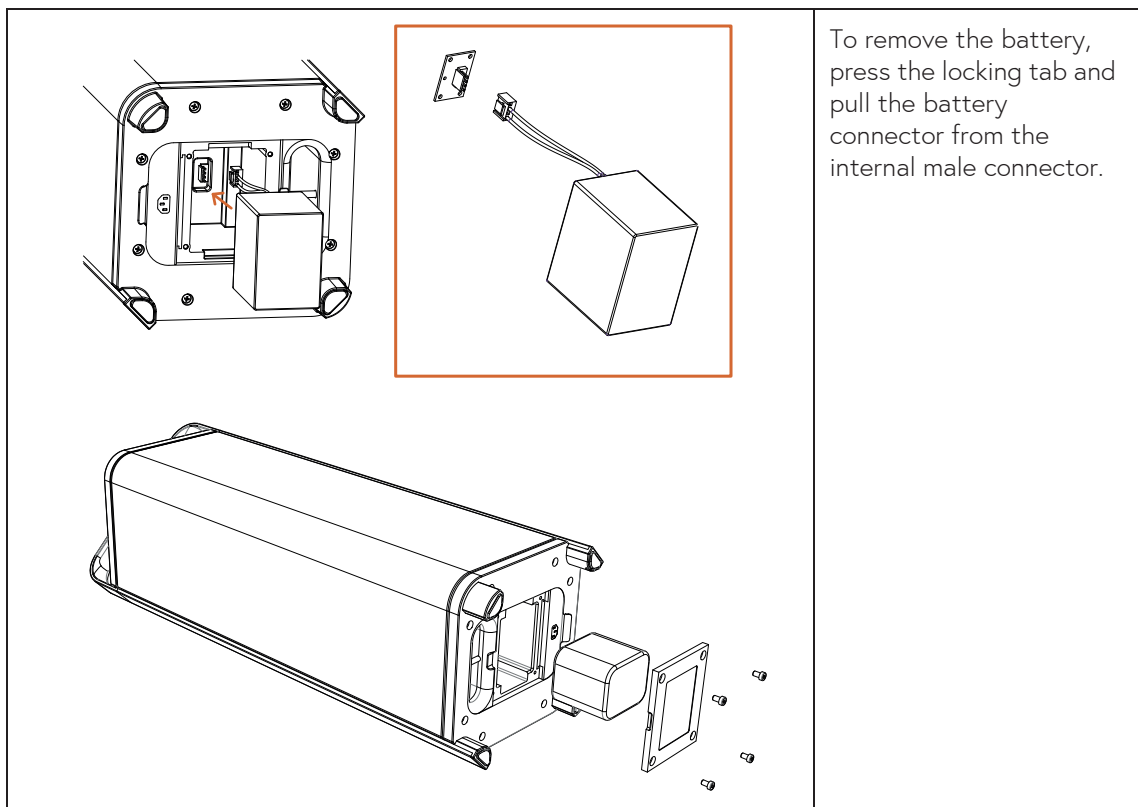

Figure 1-1: Example of a 4mm steel cable

Attention: As a manufacturer, we or any of our affiliates, partners or retailers accept no liability for any losses or damages of the product (whether direct, indirect, special, consequential or otherwise).

8.4 Replacing the battery

1. Disconnect the Escape™ P9 from the power outlet.
2. Carefully place the Escape™ P9 on its side on a flat, clean surface.



3. Remove the battery cover screws and remove the battery cover.

4. Pull out the battery and disconnect the female battery wiring harness connector from the internal male connector.
5. Reinstall the female wire harness connector from the replacement battery into the male connector. To plug in this type of connector correctly, ensure that the molex connector is oriented correctly. Do not force the plug. Gently apply pressure.

The connector can only be connected in one direction. Make sure not to reverse the polarity. This may cause permanent damage to the internal electronics and repair costs will not be covered under warranty.

6. Reinstall the battery cover and the screws.

⚠ Caution: Only replace the battery with an original Escape™ P9 battery. As with all batteries, there is a risk of explosion or personal injury if the battery is replaced with an incorrect type.

9 App

Dedicated Escape® Remote app for iOS® and Android™. Select different audio sources, adjust the start-up volume, choose between 3 different optimized DSP and equalizer pre-settings (standard, indoor, outdoor) and 1 custom setting via a 5-band graphic equalizer to create a responsive curve more appealing to your personal taste. Thanks to the dual 24-bit DSP processor you can switch between a direct or wide soundstage. Adjust the balance between two speakers in Twin mode and lock the keypad control buttons (useful in professional settings such as bars and restaurants).

The Escape® Remote App can be downloaded on the Apple App Store or the Google Play Store. The separate user manual for the app can be downloaded on the website.



Important! For the Remote app to work properly, the P9 MCU firmware must be version V3.18 or higher. More information can be found on the Escape website.

10 Frequently Asked Questions

Please consult the website www.escapespeakers.com to read the troubleshooting section.

11 Specifications

11.1 Full-range drivers

Detailed 360° omnidirectional sound. The Escape™ P9 delivers the most detailed sound reproduction with its 4 individual 3" full-range drivers with aluminum dust caps and optimized deep polypropylene (PP) cones, linear flat spider and vented voice coil.

11.2 Amplifier

100 Watt RMS Digital Amplifier with a frequency response of 20Hz-20KHz.

11.3 Dual 24-bit DSP processor

Two powerful 24 bit DSP processors offers music enthusiasts the ultimate audio sensation.

11.4 Subwoofer

8-inch subwoofer with a custom designed fiberglass composite reinforced basket, oversized magnet, linear flat spider and vented voice coil for both powerful and deep accurate bass response.

11.5 Rechargeable lithium iron phosphate battery

LiFePo4 19.2 V 3Ah 57.6Wh battery for 8 hours of play time at normal listening level. Internal power supply (240 V/50 Hz, 110 V/60 Hz) for easy and convenient recharging of the battery.

 Do not expose the battery to temperatures above 60°C.

11.6 Bluetooth®

Bluetooth® 4.2 (CSR 8670)

Powered by Qualcomm® aptX™ audio

Supports Advance Audio Coding (AAC™), SBC audio codecs and A2DP 1.3.1

11.7 Dimensions

220 x 220 x 731,5mm

11.8 Weight

Net weight = 12,30 kg - 27.12 lbs

Gross Weight = 12,95 kg - 28.55 lbs

11.9 Additional audio inputs

1. universal 3.5mm auxiliary input (Aux 1)
2. USB flash drive input
3. universal 3.5mm auxiliary input (Aux 2) located in a weather-resistant compartment underneath the keypad with a USB power output to accommodate future generation receivers.

11.10 Design

Designed for the outdoors. Waterproof grill made out of a multi-filament, high-tenacity polyester yarn with a soft feel and natural material effect. Optimized weave openness for a crystal clear sound. Elegant and well-balanced powder-coated die cast aluminum handle and extruded side trims.

12 Cleaning instructions and fabric care

1. Dampen the grille fabric manually with clear cool or moderately warm water or add a diluted solution of non-aggressive liquid soap using a soft sponge.

 Do not use a pressure washer. This will damage the speaker.

2. Leave to act for 2 or 3 minutes depending on the amount of dirt on the unit.
3. Use a natural bristle soft brush to brush out towards the edges.
4. Rinse with clear water to remove all traces of the soapy solution.

 **Note:** If the product comes into contact with other materials, rinse immediately.

5. Repeat the cleaning process if necessary.

The fabric may show irregularities in the weaving. Do not pull on any loose threads, but cut and remove carefully with small scissors.

Clean the other parts of the unit with a soft sponge and a mixture of moderately warm water and non-aggressive liquid soap.

 **Caution:** Do not spray or pour water into the woofer port located at the bottom of the P9

13 Warranty

13.1 Limited warranty for the unit

The unit is covered by a 1-year limited warranty (*) from the date of invoice when used in accordance with the Escape™ P9 user manual. The warranty includes any spare parts and labor required to repair the product. This warranty does not cover damage caused by abuse, accident, misuse, negligence, or improper operation or installation, products that have been modified or products whose identifying number or serial number have been altered, defaced, or removed. For this warranty to apply, you must use the unit according to the instructions.

13.2 Limited warranty for the battery

The battery is covered by a 6-month limited warranty worldwide.

- 13.3 **Caution :** Marking and rating plate are located at the bottom of the enclosure of the apparatus.

13.4 Returning a device for repairs

1.  Pack the speaker in the original shipping box or a corrugated container with at least 3 inches / 7.5cm of resilient material to protect the unit from damage in transit.

Note: Escape™ is not responsible for any damage during transportation.

2. Bring the unit and proof of purchase to your retail store, along with a note explaining the nature of service required.

3. If the store of purchase's personnel cannot help you, please send an email to service@escapespeakers.com with a description of the defect, proof of purchase and serial number for a Return Merchandise Authorization number before returning the unit for repair.
4. Write the RMA number on the shipping label and ship to: **Escape BV** - Ter Heidelaan 50a - 3200 Aarschot - Belgium or an authorized service center.

Escape™ sells products only through authorized channels to ensure that customers obtain proper support and service. Any Escape™ product purchased from an unauthorized dealer or source will not be honored or repaired under the existing warranty policy. Any sale of products by an unauthorized source or other manner not authorized by Escape BV shall void the warranty on the applicable product. Please check our website for the list of authorized Escape™ retailers.

 **Note:** (*) Escape™'s limited warranty does not modify, affect or substitute the rights under statutory consumer protection laws that may vary from country to country.

14 Copyright information

The Bluetooth® word mark and logos are registered trademarks owned by the Bluetooth SIG, Inc. and any use of such marks by Escape™ under license.

Qualcomm® is a trademark of Qualcomm Incorporated, registered in the United States and other countries, used with permission. aptX™ is a trademark of Qualcomm Technologies International, Ltd., registered in the United States and other countries, used with permission.

iOS® operating system is a trademark of Apple Inc., registered in the U.S. and other countries.

Android™ is a trademark of Google LLC.

The AAC™ logo is a trademark of Dolby Laboratories. Other trademarks and trade names are those of their respective owners.

Patents

14.1 European Union Design Patent No 003162122-0001

China Model Design Patent No 201630320579.X

United States Design Patent No US D805,499 S

Directives

14.2 This product is in compliance with directives of relevance, including RoHS directive.

Declaration of conformity

14.3 The declaration of conformity for the Escape™ P9 can be found and downloaded on the website.

See also the product label for more regional regulatory approvals.

14.4 Brand information

Escape™ is a brand of:
Escape BV
Ter Heidelaan 50a
3200 Aarschot
Belgium

www.escapespeakers.com

14.5 Images

Images of the Escape™ products are the intellectual property of Escape BV.

Any reproduction, modification, distribution or other use, even partial, of this document is prohibited without prior written permission.