



HI-Res Multi- Room WiFi and Bluetooth aptX HD Audio Streamer.  
All inputs re-stream to WiFi and Bluetooth aptX HD headphones  
and speakers

WR-2  
USER'S MANUAL

## Table of Contents

FCC Notice - Declaration of Conformity Information.....	2
EU Declaration of Conformity .....	3
SAFETY INSTRUCTIONS .....	4
Introduction.....	7
System Architecture .....	7
Features .....	8
Accessories .....	9
Remote Control & Corresponding IR Codes .....	9
Front & Back Panels .....	10
WR2 audio signal Pair to your Bluetooth device .....	11
WR2 Restore to factory settings .....	11
NuPrime EQ Settings .....	12
Situation map .....	13
Getting Started .....	14
FACTORY RESET BY App .....	16
QUICK SETUP GUIDE .....	17
WIRELESS AUTO SETUP .....	18
Select Bluetooth and other input segments on the APP .....	24
NuPrime’s Limited Warranty and Limitation of Liabilities .....	27

### FCC Notice - Declaration of Conformity Information

This equipment has been tested and found to comply with the limits for a Class B digital device, pursuant to part 15 of the FCC Rules. These limits are designed to provide reasonable protection against harmful interference in a residential installation. This equipment uses and can radiate radio frequency energy and, if not installed and used in accordance with the instructions, may cause harmful interference to radio communications.

However, there is no guarantee that interference will not occur in a particular installation. If this equipment does cause harmful interference to radio or television reception, which can be determined by turning the equipment on and off, the user is encouraged to try to correct the interference by one or more of the following measures:

- Reorient or relocate the receiving antenna.
- Increase the separation between the equipment and receiver.
- Connect the equipment into an outlet on a circuit different from that to which the receiver is connected.
- Consult the dealer or an experienced radio/TV technician for help.

**WARNING:** Only peripherals complying with the FCC class B limits may be attached to this equipment.

Changes or modifications made to this equipment, not expressly approved by us or parties authorized by us could void the user's authority to operate the equipment. This device complies with part 15 of the FCC Rules. Operation is subject to the following two conditions: (1) This device may not cause harmful interference, and (2) this device must accept any interference received, including interference that may cause undesired operation.

### EU Declaration of Conformity

**CE** Hereby, NuPrime Audio, Inc. declares that this device is in compliance with the essential requirements and other relevant provisions of Directive 2004/108/EC.

The manufacturer of this product is NuPrime Audio, Inc., 1712 Pioneer Ave. Ste 1817, Cheyenne, Wyoming 82001, USA.

The Authorized Representative for EMC and product safety is NuPrime Audio, Inc., 1712 Pioneer Ave. Ste 1817, Cheyenne, Wyoming 82001, USA.

For any service or guarantee matters please refer to the addresses given in separate service or guarantee documents.

### For Customers in Europe



Disposal of Old Electrical & Electronic Equipment (Applicable in the European Union and other European countries with separate collection systems)

This symbol on the product or on its packaging indicates that this product shall not be treated as household waste. Instead it shall be handed over to the applicable collection point for the recycling of electrical and electronic equipment.

By ensuring this product is disposed of correctly, you will help prevent potential negative consequences for the environment and human health, which could otherwise be caused by inappropriate waste handling of this product. The

recycling of materials will help to conserve natural resources. For more detailed information about recycling of this product, please contact your local Civic Office, your household waste disposal service or the shop where you purchased the product.

## Safety Instructions

There are two categories of Safety Instructions included in this manual:

- Product Warnings, (i.e., what must never be done to assure avoiding those hazards that could cause bodily injury or property damage); and
- User Directions (i.e., what must always be done to assure the safe use of your device).

The Safety Instructions contained in this manual have been categorized in accordance with the seriousness of the potential hazards through the use of Signal Words. Those Signal Words, and their intended meanings, are as follows:

**DANGER:** Indicates that a failure to observe the Safety Instructions could result in death or catastrophic bodily injury.

**WARNING:** Indicates that a failure to observe the Safety Instructions could result in serious bodily injury.

**CAUTION:** Indicates that a failure to observe the Safety Instructions could result in minor bodily injury or property damage.

**NOTE:** Designates important information that relates to activities and/or conditions that might result in loss of data and/or damage to your device.

## Safe Use and Operation of Your Device

This equipment emits stray RF energy and will interfere with the reception of signals by airborne electronic navigational devices or medical devices. Do not operate this equipment near any sensitive medical devices.

**WARNING: Use only grounded AC power cords.**

Always immediately disconnect the power to the equipment in the event the device emits an unusual odor or sound or generates smoke.

**WARNING:** Never attempt to disassemble, repair or make any modification to your device. Disassembly, modification or any attempt at repair could cause bodily injury or property damage, as well as damage to the device itself.

**WARNING:** Your device is not a toy. Never allow children to play with your device. Misuse, rough or improper handling of your device by children could result in serious bodily injury for any of the enumerated safety warnings in this manual. In addition, always keep all accessories and components out of the reach of small children as small parts might present a choking hazard. Seek immediate medical attention if choking occurs or if any small part has been swallowed.

**CAUTION:** Never raise the sound volume level too high when using your device with earphones. An excessive sound volume level could cause damage to your hearing.

**WARNING:** To reduce the risk of fire or electric shock, do not expose the unit to moisture or water.

Do not allow foreign objects to get into the enclosure. If the unit is exposed to moisture, or a foreign object gets into the enclosure, immediately disconnect the power cord from the wall.

Take the unit to a qualified service person for inspection and necessary repairs.

Read all the instructions before connecting or operating the component.

Keep this manual so you can refer to these safety instructions.

Heed all warnings and safety information in these instructions and on the product itself. Follow all operating instructions.

Do not use this unit near water.

You must allow a minimum 10 cm or 4 inches of unobstructed clearance around the unit.

Do not place the unit on a bed, sofa, rug, or similar surface that could block the ventilation openings. If the unit is placed in a bookcase or cabinet, there must be ventilation of the cabinet to allow proper cooling.

Keep the component away from radiators, heat registers, stoves, or any other appliance that produces heat.

The unit must be connected to a power supply only of the type and voltage specified on the rear panel. Connect the component to the power outlet only with the supplied power supply cable or an exact equivalent. Do not modify the supplied cable.

Do not route the power cord where it will be crushed, pinched, bent, exposed to heat, or damaged in any way. Pay particular attention to the power cord at the plug and where the cord exits the back of the unit.

The power cord should be unplugged from the wall outlet during a lightning storm or if the unit is to be left unused for a long period of time.

Immediately stop using the component and have it inspected and/or serviced by a qualified service agency if:

- The power supply cord or plug has been damaged.
- Objects have fallen or liquid has been spilled into the unit.
- The unit has been exposed to rain.
- The unit shows signs of improper operation.
- The unit has been dropped or damaged in any way

## Introduction

NuPrime Omnia WR-2 is a versatile multi-zone WiFi and Bluetooth aptX HD audio streamer capable of streaming music from online services, local USB pen drive, network storage (DLNA NAS), and other connected digital and analog sources. The free iOS and Android Apps allow you to easily control your smart music system, select your source music and group destination speakers (including receiving streamers).

## System Architecture

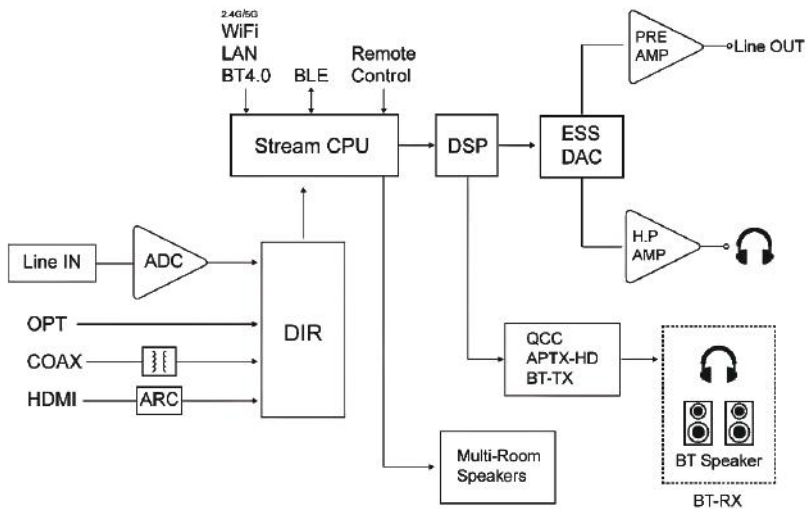

WR-2 versatility lies in its architectural design, where all inputs, Wi-Fi, and Bluetooth data are routed to a streaming CPU module for processing. The digital data can be re-streamed to multi-room Wi-Fi receivers or a Bluetooth device or decoded for lineout or headphone out.



**Features:**

- Outputs: Coaxial (USB Type-C), Line Out , 3.5mm Headphone Amp, 12V Trigger Out
- Inputs: Line In, HDMI ARC, Optical, Coaxial, USB Pen Drive
- All inputs re-stream to WiFi and Bluetooth aptX HD headphones and speakers
- Ethernet RJ45, 2.4.GHz & 5GHz WiFi, 2-way Bluetooth aptX HD
- Audio file decoding up to 24bit/192KHz
- Streaming protocols Airplay2, DLNA, UPnp, Spotify Connect, Tidal Connect & Qplay
- Streaming services: Amazon Music, Deezer, iHearRadio, Napster, QQ music, Qobuz, Spotify, Tidal, TuneIn, and others
- Support multi-room streaming up to 8 zones
- NuPrime proprietary EQ settings
- OLED display for music information
- NuPrime Omnia App for Android and iOS
- Dimension: 151 mm W x 136 mm D x 51 mm H (including feet)
- Weight: 0.8 kg
- Color: Black (PANTONE 19-3924 Night Sky)

\*Wireless re-streaming and SPDIF output are limited to 44.1K (CD Quality) to ensure multi-room streaming performance requirement.

## Accessories

- Customized power adapter (5V2A) includes Euro and US connector
- USB Type A-C Cable with mesh shielding, Length 1M
- RCA Cable: RCA TO RCA, Length 1.2M
- HDMI Cable: FOR HDMI ARC, Length 1M
- Fiber optic Cable: Length 1M
- Remote-Control for WR2
- Antenna for WIFI 3dBi 2.4/5 GHz Dual-band (RP-SMA-J Male)
- Antenna for Bluetooth TX 3dBi (SMA-J Male pin)



SMA-J Male



RP-SMA-J Male

## Remote Control & Corresponding IR Codes



## Front & Back Panels

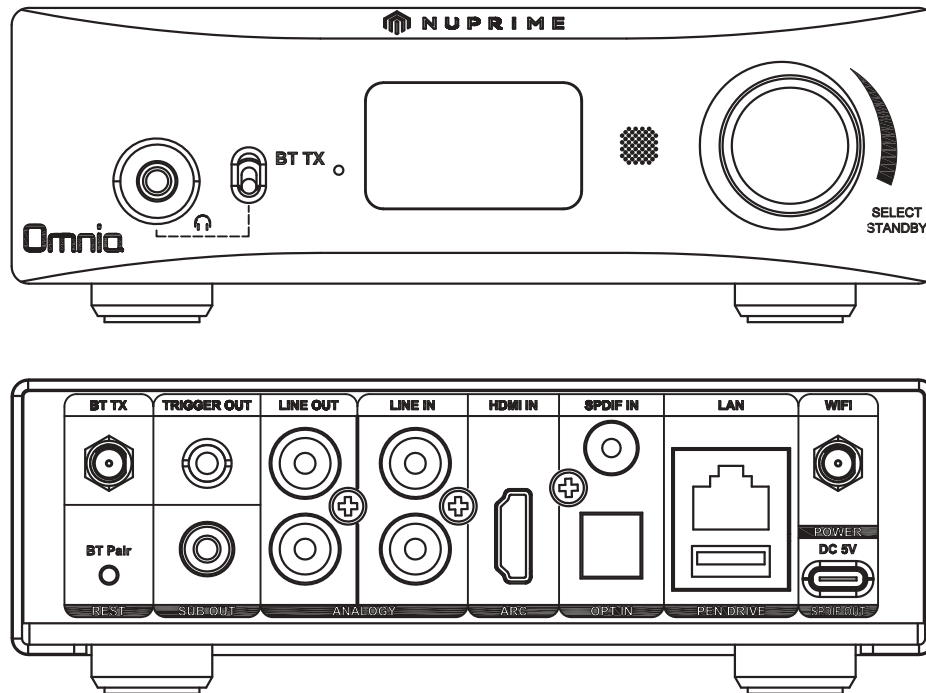

Refer to User Guide section for information regarding the I/O ports.

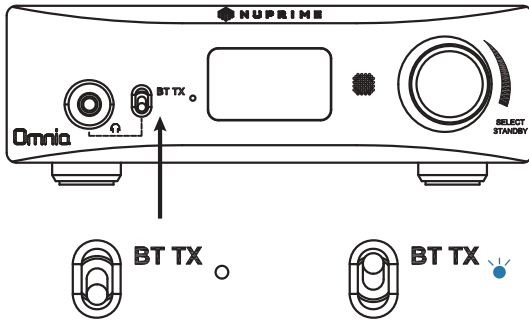

### WR2 audio signal Pair to your Bluetooth device

1. Turn the panel switch to "BT TX"
2. Quickly press the "BT Pair" button once, at which point the blue light on the front panel will flash quickly, allowing you to pair the Bluetooth transmitter with your Bluetooth device.
3. Turn on the pairing mode for your Bluetooth device and place it as close as possible to WR2.
4. When the blue light on the front panel stops flashing, it means the pairing is successful! WR2 recognizes this Bluetooth device and there's no need to pair again in the future.

Enjoy your wonderful wireless music!

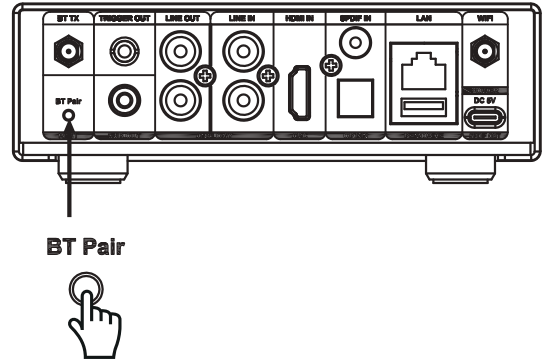

### WR2 Restore to factory settings :

Hold the button for three seconds to trigger resetting the WiFi settings and restoring factory settings.

## NuPrime EQ Settings

NuPrime proprietary EQ settings allow the users to customize their listening experience according to music preferences and audio equipment matching. Loudness 1, 2 & 3 settings came from the R&D effort of the AMG series. Despite its name, Loudness settings create a presence of warmth and impact for the listener instead of louder sound.

Repeatedly pressing the Loudness button will cycle through the following EQ settings:  
*Flat, Loudness 1, Loudness 2, Loudness 3, Rock, Jazz, Pop, Classic*

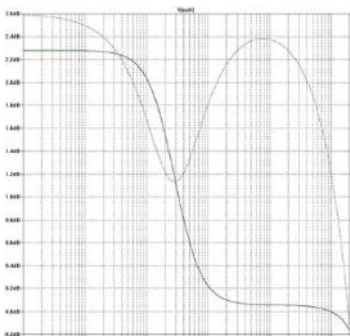

Loudness1

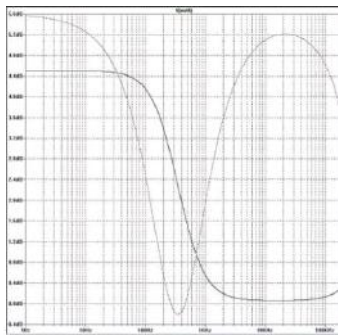

Loudness2

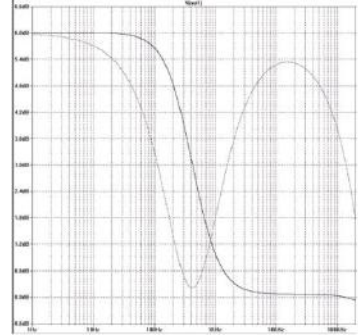

Loudness3

Situation map:



## Getting Started

### Overview

The diagram below illustrates a typical setup whereby the Omnia WR-2 would be used.

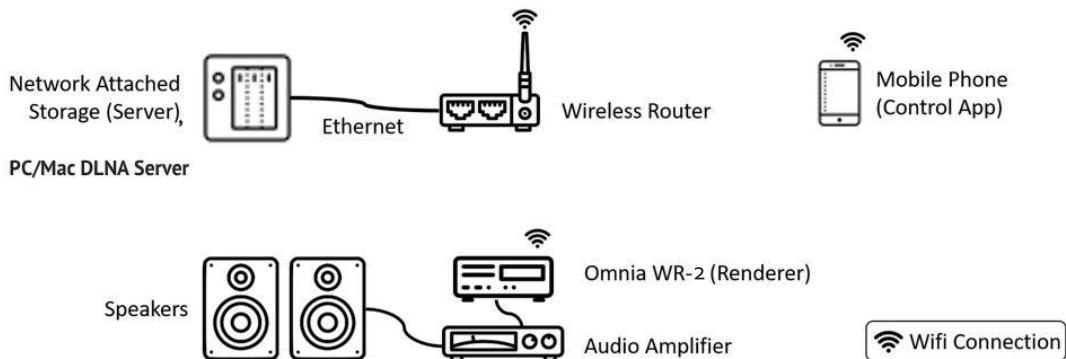

It is not necessary to use the exact components illustrated in the diagram. The Server could be a dedicated DLNA compatible music server audio equipment or a PC/Laptop running DLNA server software. You could also connect the Omnia WR-2 to the router using an Ethernet cable and its audio output to an active speaker.

For best performance, we recommend that all audio components, including DLNA Server, connect to the NuPrime Omnia SW-8 network switch.

## Setting up the Omnia WR-2

Download and install the Omnia Receiver App to your iOS device from the App Store or your Android device from the Google Play Store.

Before using the Omnia Receiver App, make sure that the Omnia WR-2 has been properly connected according to the instructions below.

- Plug in the Type C USB cable to the Omnia WR-2 power input and the other end of the cable either to a NuPrime USB Extension Port (available on devices such as the IDA-8 and DAC-9) or a 5V USB power source.
- If not using the NuPrime USB Extension Port, connect the desired audio output (Digital Coax or Analog) to amplifier or active speaker.
- For wired network connection, connect the LAN cable from your router to the RJ45 Ethernet port on the Omnia-WR-2
- Turn on the power of the Omnia WR-2

## Configuring the Omnia WR-2

When you first launch the Omnia Receiver App, it will automatically search for the Omnia WR-2. If it does not detect any compatible devices, the App will show the following screen:



## FACTORY RESET BY App

Restore to factory default settings by App's  
function setting→ Speaker Info→ Restore Factory Settings

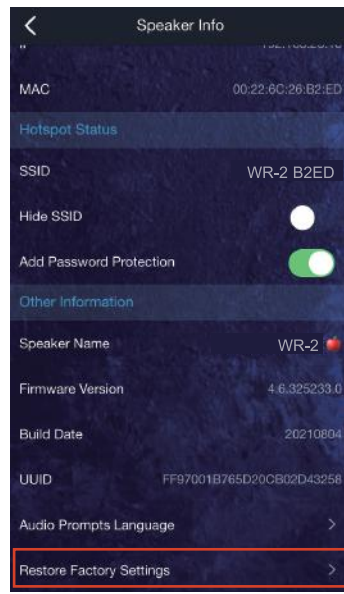
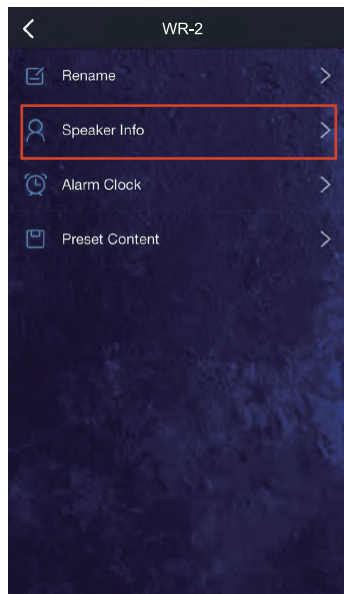
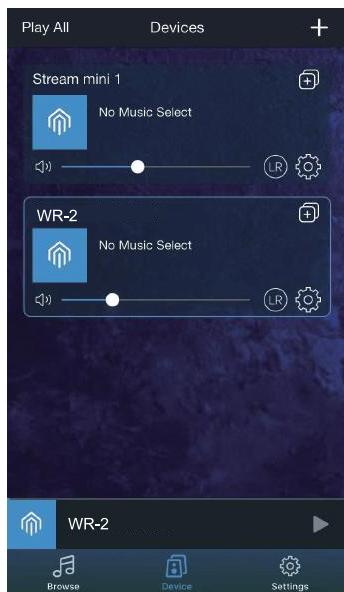

## QUICK SETUP GUIDE

Your WR-2 can be connected to your home network via wireless connection.

### IMPORTANT!

- Ensure that a broadband router that supports Wi-Fi standards is available.
- Use tablets, smartphones, and other applicable devices that support iOS (Apple) or Android operating systems as mobile device controllers.
- Download and install the Omnia Receiver App to your iOS device from the App Store or your Android device from the Google Play Store.
- Update your WR-2 with the latest firmware. Go to the WR-2 product page at [nuprimeaudio.com](http://nuprimeaudio.com) for firmware update information.

WR-2 turns on automatically when connected to power.

## WIRELESS AUTO SETUP

①

When you first launch the Omnia Receiver App, it will automatically search for the WR-2 .

If it does not detect any compatible devices, the App will show the following screen:

①

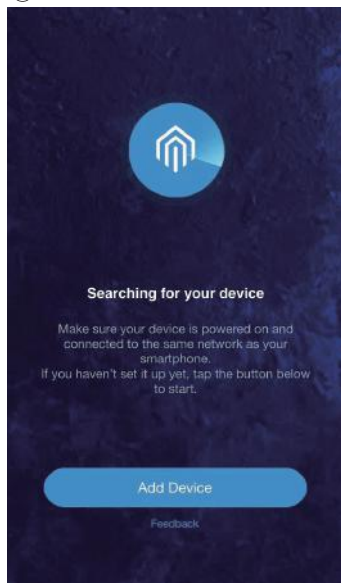

②

If you haven't pressed the reset button on the rear panel once And follow up the App's instruction after power on, do it now.

②-1

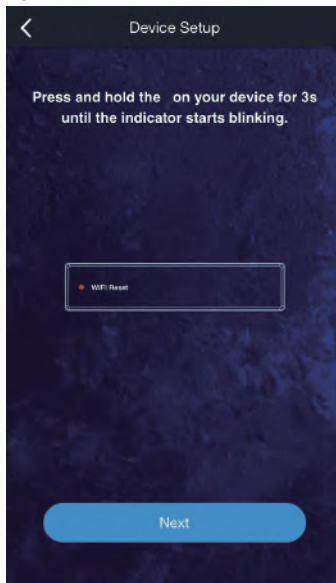

②-2

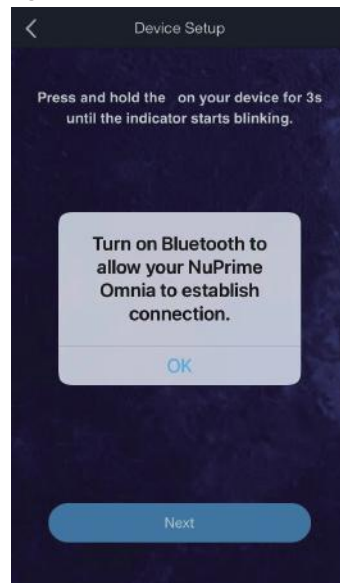

- ③ Select WR-2 device  
(the Omnia Receiver App called all receiving devices as Speaker).



- ④ Configure Wi-Fi setup on WR-2 by selecting the same SSID of the Wi-Fi network on your mobile device

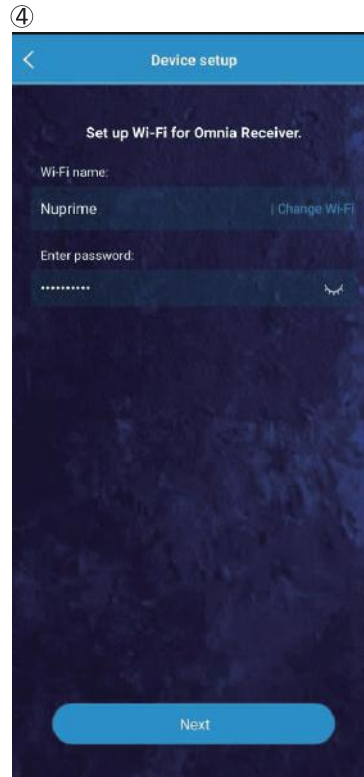

⑤

Wait for the WR-2 to connect to the selected Wi-Fi network

⑤

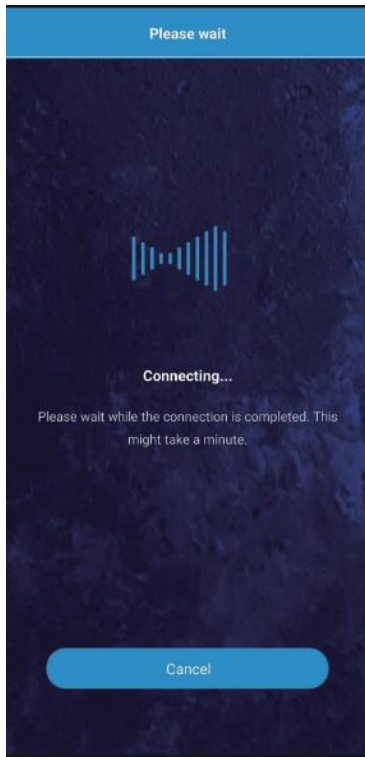

⑥

Device is connected.

⑥

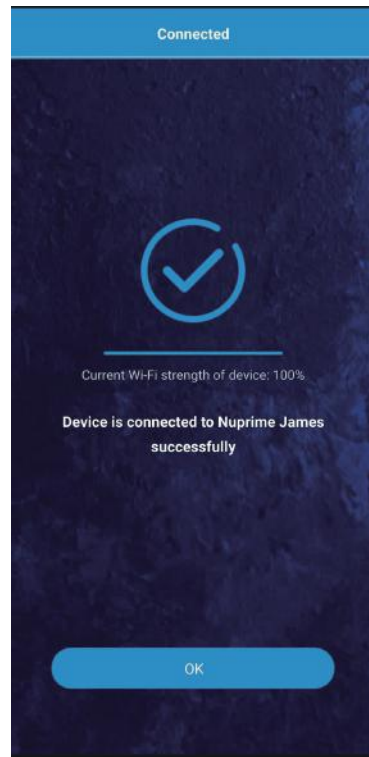

⑦

- When you choice “+”, you could add new device here (must in the same network)
- When you choice “⚙️”, you could setup device and get information here.

⑦

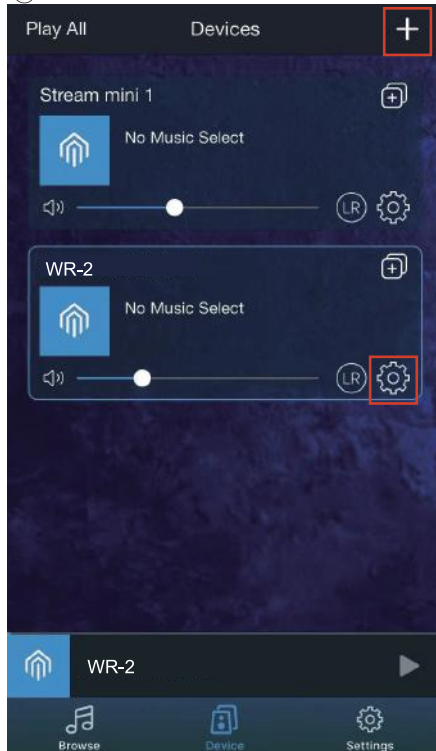

⑧

You could modify/ customize the name of device and other functions here.

⑧

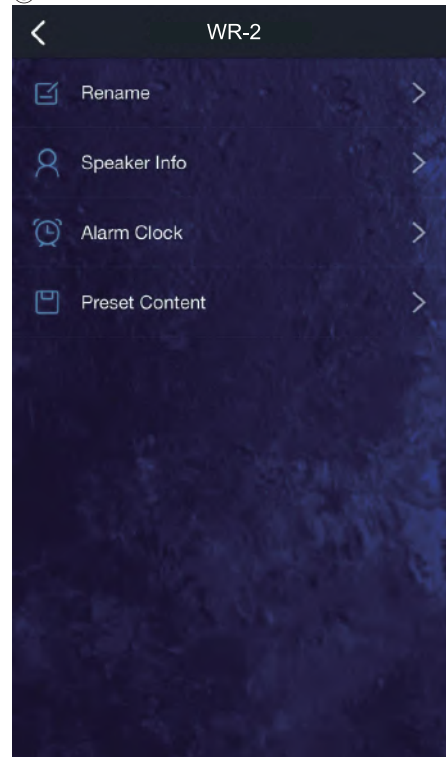

⑨

Play music using theNuPrime Omnia App as a functional remote control

⑨



⑩

Select “Add More Services” to hide or show the list of musicservices. Most of these servicescan be entirely controlled by the Omnia Receiver App. For Spotify, you will need to have their App installed, and first use their App to play to the Omnia Receiver. You can then control the playlist from the Omnia Receiver App.

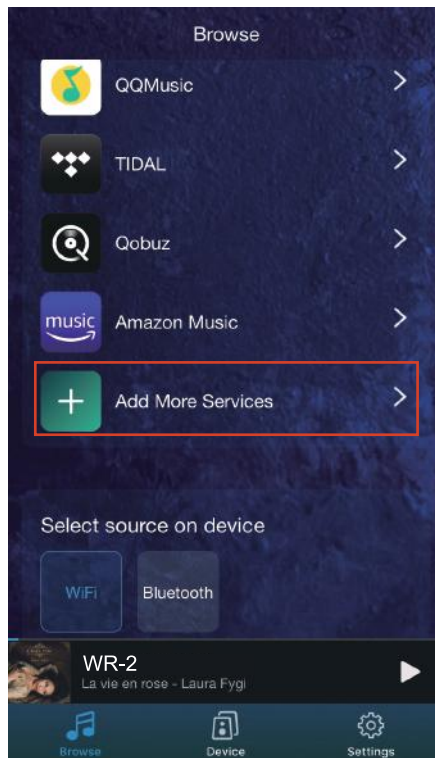

11

You could search, chose, and edit the playlist here. Ex: When you select "MY MUSIC", you will see the number of songs that are stored on the different devices.

11-1

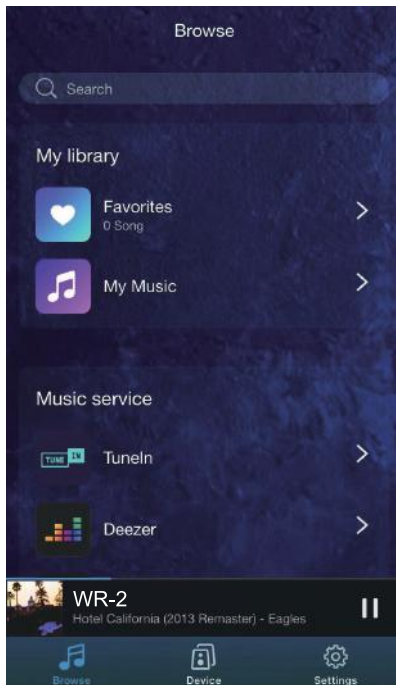

11-2

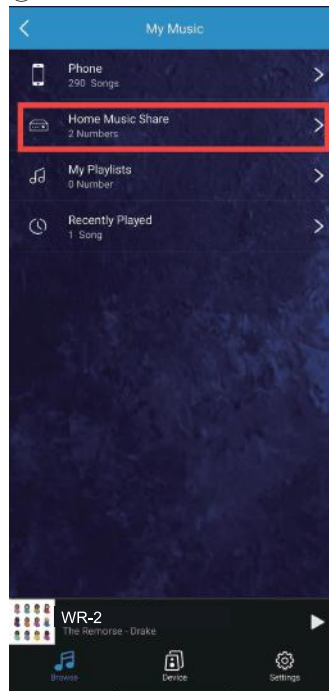

11-3





## Select Bluetooth and other input segments on the APP

⑫-1

When selecting Bluetooth mode for the first time, power on the WR-2 to automatically enter the Bluetooth pairing mode (Flashing blue light on the front panel). Turn on the Bluetooth function of the mobile device and connect to the Bluetooth pairing name "WR-2." The indicator light is a blue bright when successfully connected.

⑫-1

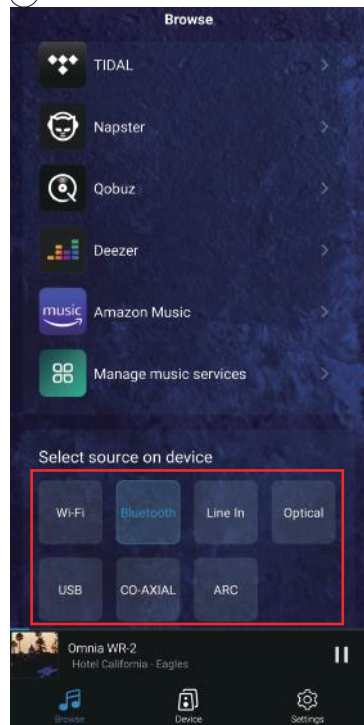

⑫-2

Please select the input segment you need on the APP

## Spotify Connect



Use your phone, tablet or computer as a remote control for Spotify. Go to [spotify.com/connect](https://spotify.com/connect) to learn how.

The Spotify Software is subject to third party licenses found here:  
<https://www.spotify.com/connect/third-party-licenses>

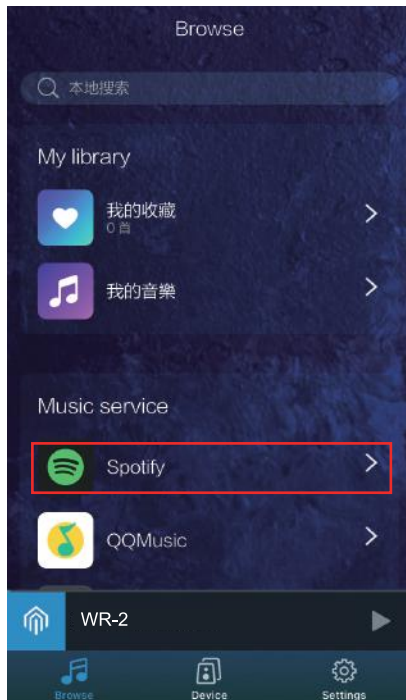

## SET UP Spotify App

- You'll need a phone, laptop, or tablet with the latest Spotify App.
- Add another device that supports Spotify or has the App (like a speaker or laptop).
- Connect both devices to the same Wi-Fi network, and log in to Spotify.
- Fire up the Spotify App on your phone, laptop, or tablet.
- Play a song and select Devices Available.
- Select your device and start listening.

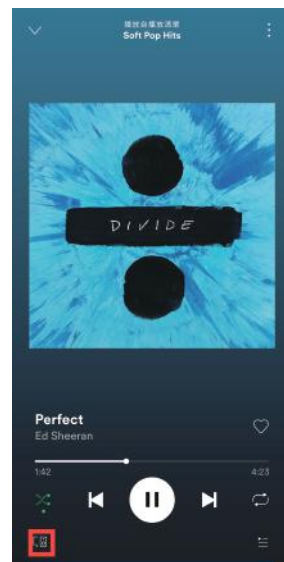
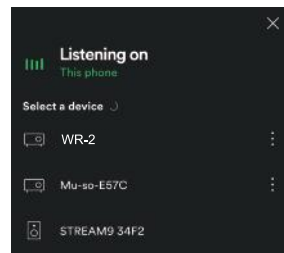
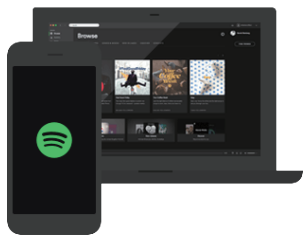

## NuPrime's Limited Warranty and Limitation of Liabilities

### ADDITIONAL RIGHTS

For consumers, who are covered by consumer protection laws or regulations in their country of purchase or, if different, their country of residence, the benefits conferred by this warranty are in addition to all rights and remedies conveyed by such consumer protection laws and regulations. This warranty does not exclude, limit or suspend any rights of consumers arising out of nonconformity with a sales contract. Some countries, states and provinces do not allow the exclusion or limitation of incidental or consequential damages or allow limitations on how long an implied warranty or condition may last, so the limitations or exclusions described below may not apply to you. This warranty gives you specific legal rights, and you may also have other rights that vary by country, state or province. This limited warranty is governed by and construed under the laws of the country in which the product purchase took place.

### LIMITED WARRANTY

For a period of ONE (1) YEAR from the date of retail purchase by the original end-user purchaser ("Warranty Period"), NuPrime warrants (in) this product against defects in materials and workmanship, and (ii) that each Product, unmodified and under normal use and conditions, will substantially comply with NuPrime' applicable written technical documentation for the Product. NuPrime reserves the right to make substitutions and modifications from time to time in the specifications of Products sold by NuPrime, provided that such substitutions or modifications do not materially affect overall Product performance.

If a hardware defect exists and a valid claim is received within the Warranty Period, at its option and to the extent permitted by law, NuPrime will (1) repair the hardware defect at no charge, using new or refurbished replacement parts, (2) exchange the product with a product that is new or which has been manufactured from new or serviceable used parts and is at least functionally equivalent to the original product, or (3) refund the purchase price of the product. NuPrime may request that you replace defective parts with user-installable new or refurbished parts that NuPrime provides in fulfillment of its warranty obligation. A replacement product/part assumes

the remaining warranty of the original product or ninety (90) days from the date of replacement or repair, whichever provides longer coverage for you. When a product or part is exchanged, any replacement item becomes your property and the replaced item becomes NuPrime's property. When a refund is given, your product becomes NuPrime's property.

## **OBTAINING WARRANTY SERVICE**

If you purchased the product in the U.S., deliver the product, at your expense, to any NuPrime Service Center located in the U.S. If you purchased the product outside of the U.S., deliver the product to any NuPrime Authorized Importer in the country where you purchased the product. Be aware, however, that not all countries have NuPrime Authorized Service Providers ('NASP') and not all Authorized Service Providers outside the country of purchase have all parts or replacement units for the product. If the product cannot be repaired or replaced in the country it is in, it may need to be sent to a different country or returned to the country of purchase at your expense for repair or replacement. If you seek service in a country that is not the country of original purchase, you will comply with all applicable import and export laws and regulations and be responsible for all custom duties, V.A.T. and other associated taxes and charges. Where international service is available, NuPrime may repair or exchange defective products and parts with comparable products and parts that comply with local standards.

You can always deliver the product to NuPrime's U.S.A or Taiwan service center for obtaining warranty service, however, you may have to pay for shipping cost.

NuPrime may send you user-installable new or refurbished replacement product or parts to enable you to service or exchange your own product ("DIY Service"). Upon receipt of the replacement product or part, the original product or part becomes the property of NuPrime and you agree to follow instructions, including, if required, arranging the return of original product or part to NuPrime in a timely manner.

When providing DIY Service requiring the return of the original product or part, NuPrime may require a credit card authorization as security for the retail price of the replacement product or part and applicable shipping costs. If you follow instructions, NuPrime will cancel the credit card

authorization, so you will not be charged for the product or part and shipping costs. If you fail to return the replaced product or part as instructed or the replaced product or part is not eligible for warranty service, NuPrime will charge the credit card for the authorized amount.

## EXCLUSIONS AND LIMITATIONS

This Limited Warranty applies only to hardware products manufactured by or for NuPrime that can be identified by the "NuPrime" trademark, trade name, or logo affixed to them. The Limited Warranty does not apply to any non-NuPrime hardware products or any accessories, even if packaged or sold with NuPrime hardware. Non-NuPrime manufacturers, suppliers, may provide their own warranties. Other accessories distributed by NuPrime under the NuPrime brand name are not covered under this Limited Warranty. This warranty does not apply: (a) to damage caused by accident, abuse, misuse, misapplication, liquid contact, fire, earthquake, non-NuPrime products, or other external causes; (b) to damage caused by service performed by anyone who is not a NASP; (c) to a product or a part that has been modified without the written permission of NuPrime; (d) to consumable parts, such as batteries, or protective coatings designed to diminish over time unless failure has occurred due to a defect in materials or workmanship; (e) to cosmetic damage, including but not limited to scratches, dents, and broken plastic on ports; (f) to defects caused by normal wear and tear or otherwise due to the normal aging of the product; or (g) if any NuPrime serial number has been removed or defaced.

**Important:** Do not open the hardware product. Opening the hardware product may cause damage that is not covered by this warranty. Only NuPrime or a NASP should perform service on this hardware product.

This warranty and remedies set forth above are exclusive and in lieu of all other warranties, remedies and conditions, whether oral or written, express or implied. NuPrime specifically disclaims any and all implied warranties, including, without limitation, warranties of merchantability and fitness for a particular purpose. If NuPrime cannot lawfully disclaim implied warranties under this limited warranty, all such warranties, including warranties of

merchantability and fitness for a particular purpose are limited in duration to the duration of this warranty. No NuPrime reseller, agent, or employee is authorized to make any modification, extension, or addition to this warranty.

NuPrime is not responsible for direct, special, incidental or consequential damages resulting from any breach of warranty or condition, or under any other legal theory, including but not limited to lost profits, downtime, goodwill, damage to or replacement of equipment and property, any costs of recovering, reprogramming, or reproducing any program or data stored in or used with NuPrime products, and any failure to maintain the confidentiality of data stored on the product. NuPrime specifically does not represent that it will be able to repair any product under this warranty or make a product exchange without risk to or loss of programs or data.

Some states and provinces do not allow the exclusion or limitation of incidental or consequential damages or exclusions or limitations on the duration of implied warranties or conditions, so the above limitations or exclusions may not apply to you. This warranty gives you specific legal rights, and you may also have other rights that vary by state or province.

Proof of purchase in the form of a bill of sale or receipted invoice which is evidence that the unit is within the Warranty period must be presented to obtain warranty service.

Replacement as provided under this warranty is the exclusive remedy of the consumer. NuPrime shall not be liable for any incidental or consequential damages for breach of any express or implied warranty on this product. Except to the extent prohibited by applicable law, any implied warranty of merchantability or fitness for a particular purpose on this product is limited in duration to the duration of this warranty.

# Beyond Ordinary



Scan to register for  
factory warranty



Scan to e-Manual