



VSA-LX805
AV AMPLIFIER / AMPLIFICATEUR AV

Initial Setup Guide

Guide de Configuration Initiale / Guía de configuración inicial



SN 29403962 O2301-0

"Pioneer" is a trademark of Pioneer Corporation, and is used under license.

1

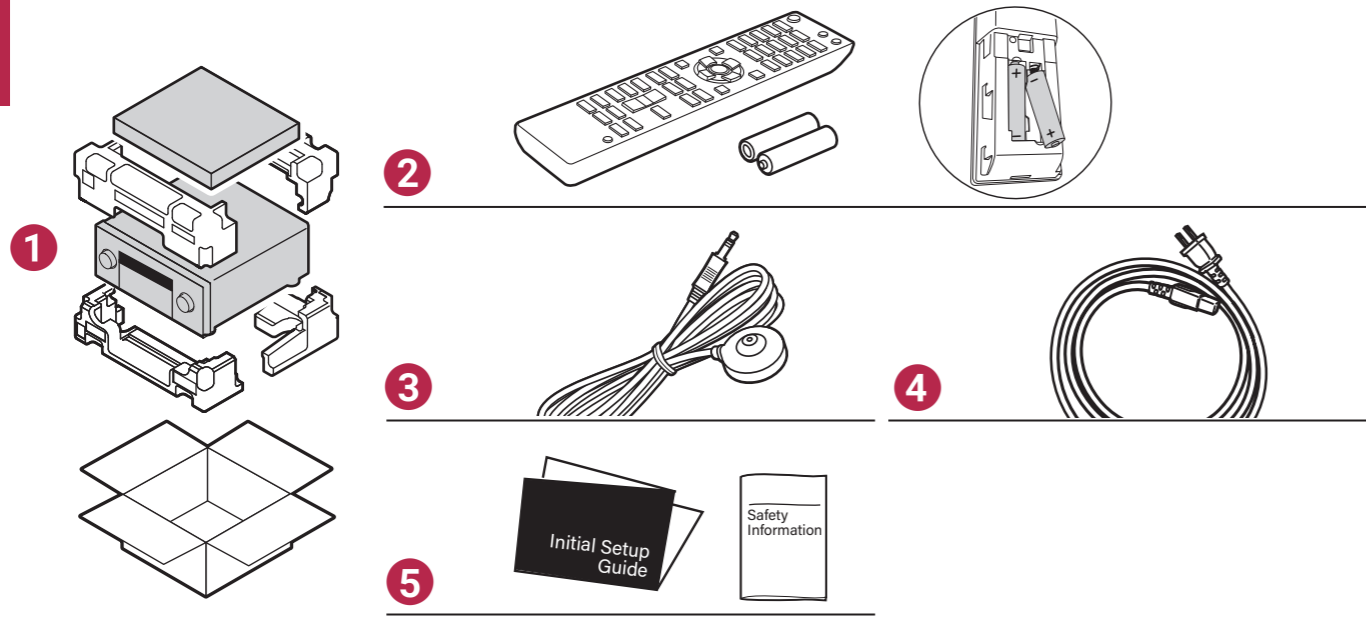

2

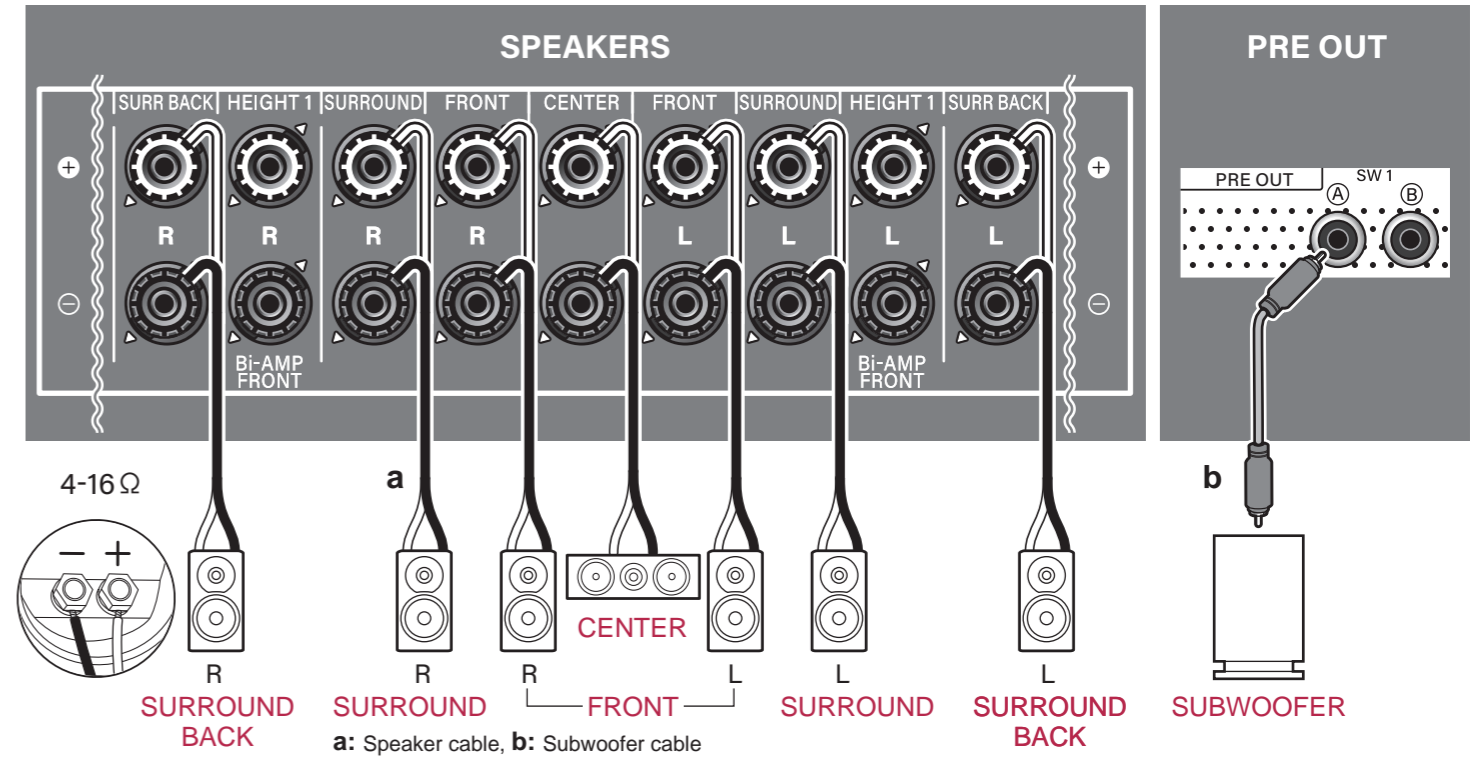
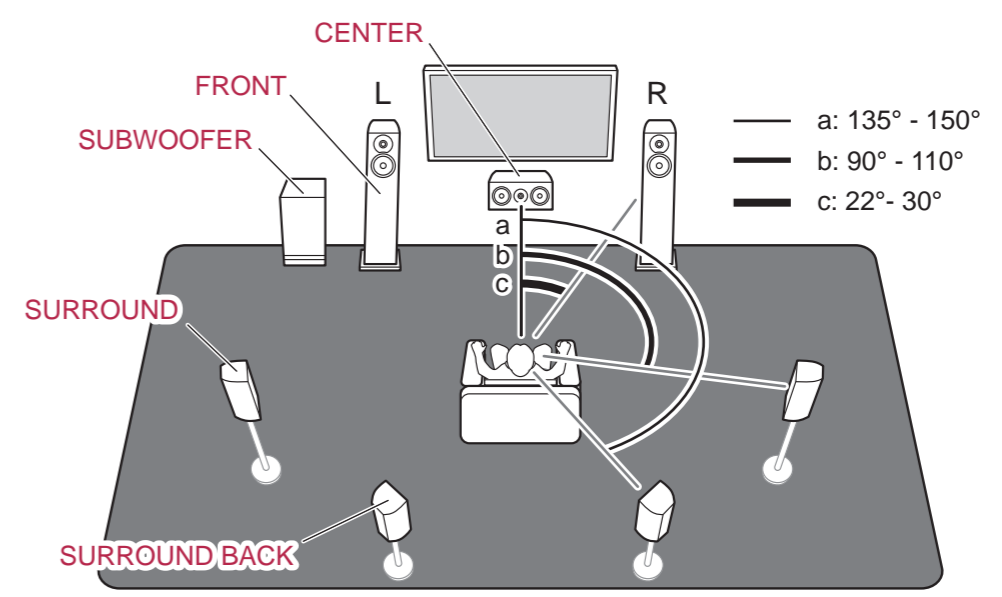
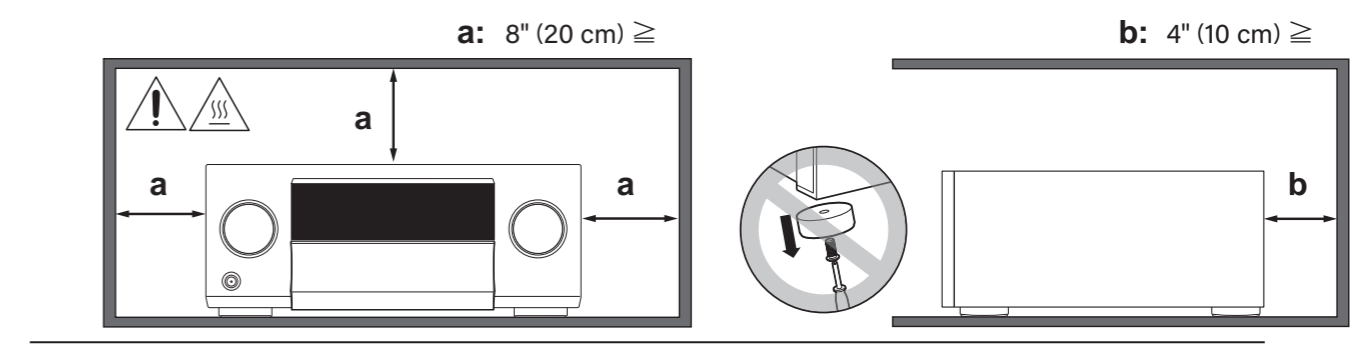

En This document uses a 7.1 channel system as an example when describing use. Refer to the online instruction manual when using other than a 7.1 channel system.

Fr Ce document utilise le système 7.1 comme exemple pour décrire l'utilisation. Consultez le mode d'emploi en ligne pour utiliser autre chose qu'un système 7.1.

Es Este documento utiliza un sistema de 7.1 canales como ejemplo para describir el uso. Consulte el manual de instrucciones online cuando utilice un sistema distinto al de 7.1 canales.



<https://jp.pioneer-audiovisual.com/manual/vsax805/top.pdf>

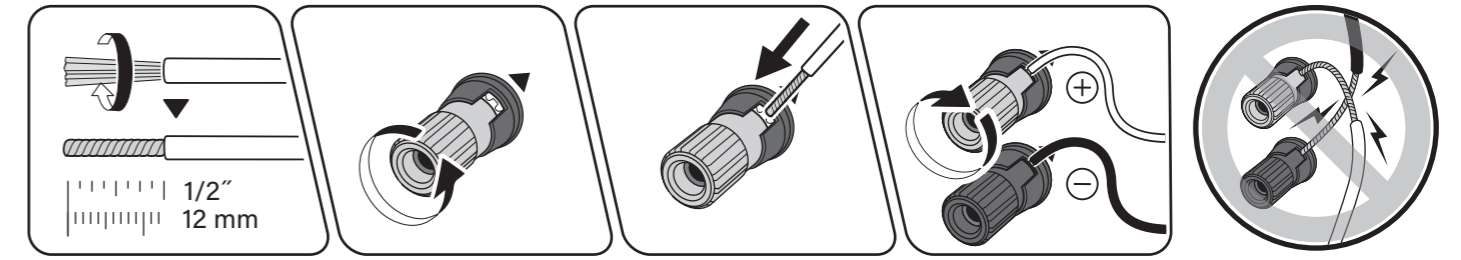

3

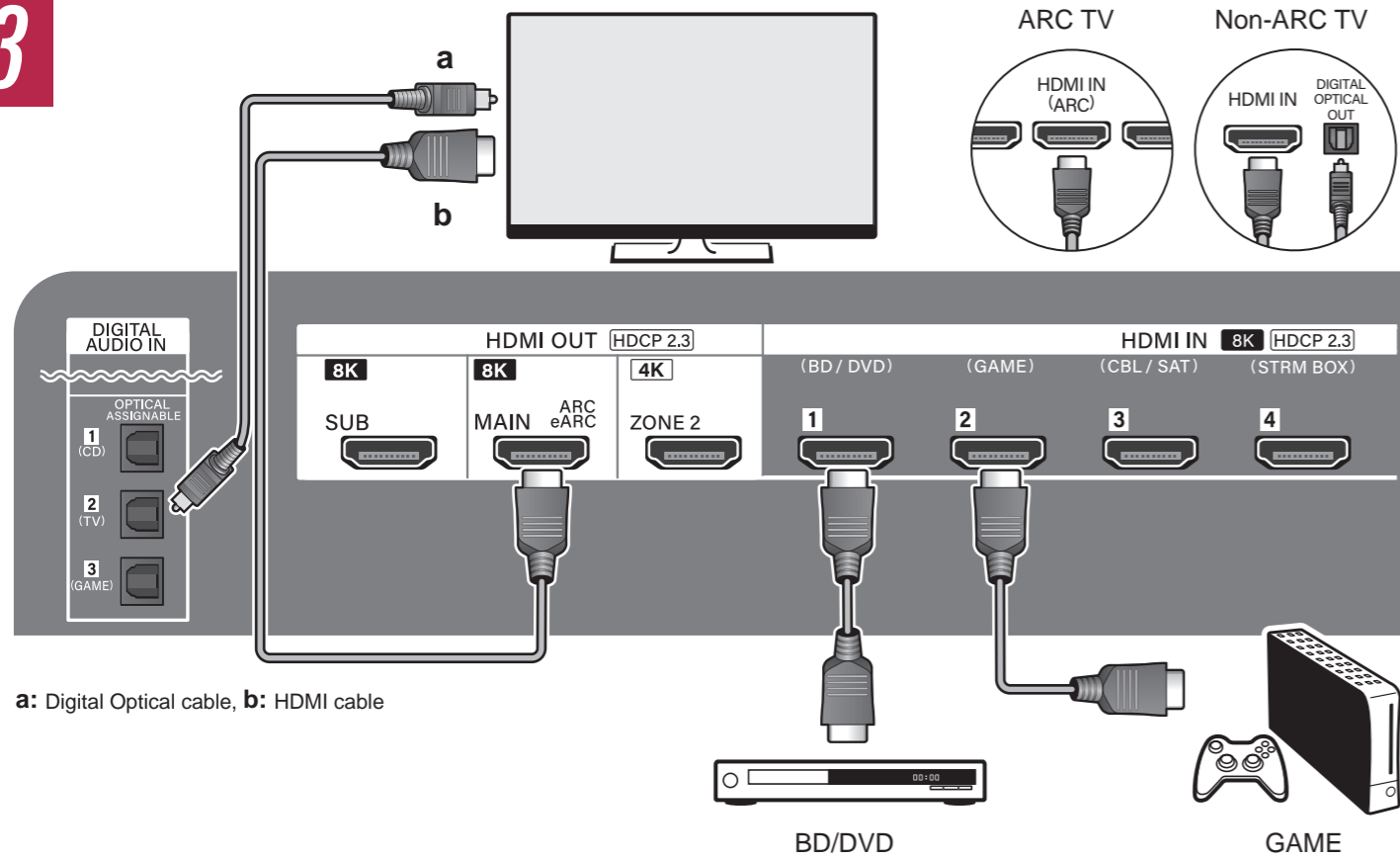

a: Digital Optical cable, b: HDMI cable

! **En** Be sure to insert the HDMI cable all the way in. / **Fr** Assurez-vous d'avoir inséré le câble HDMI à fond. / **Es** Asegúrese de insertar el cable HDMI del todo.

Wi-Fi / Bluetooth®

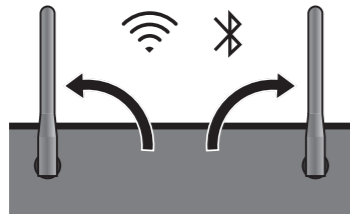

NETWORK

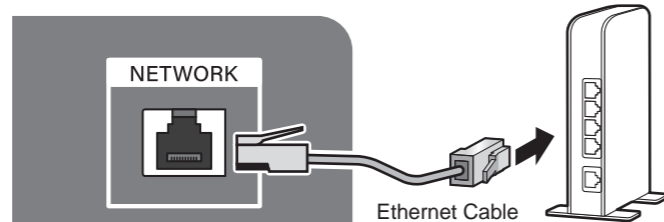

4

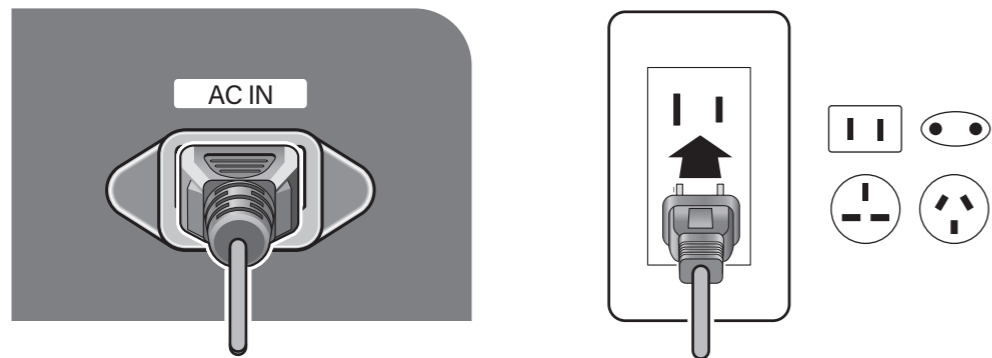

5

En Follow the guidance displayed on the screen to complete Initial Setup. / **Fr** Suivez les instructions affichées sur l' écran pour terminer la Configuration initiale. / **Es** Siga la guía mostrada en la pantalla para completar la configuración inicial.

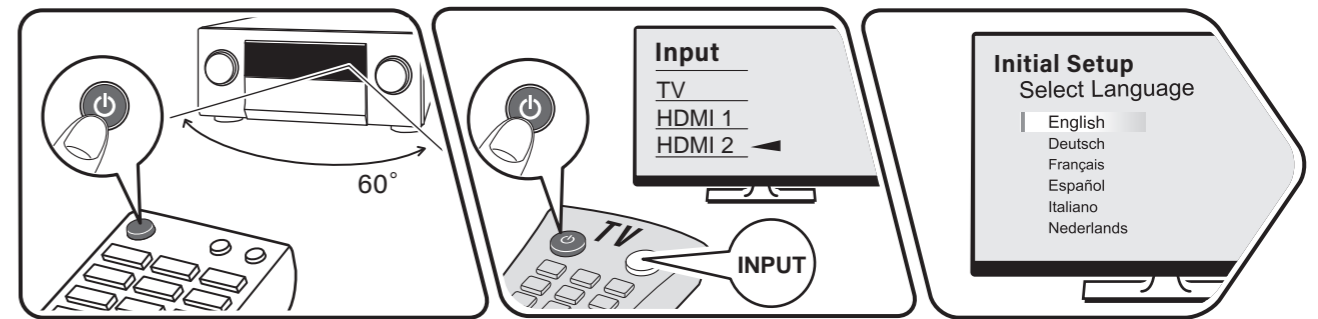

En To redo the initial setup / **Fr** Pour refaire la configuration initiale / **Es** Para rehacer la configuración inicial

System Setup > Miscellaneous > Initial Setup

6

En Playing audio & Video / **Fr** Lecture du son et de la vidéo / **Es** Reproducción de audio y vídeo

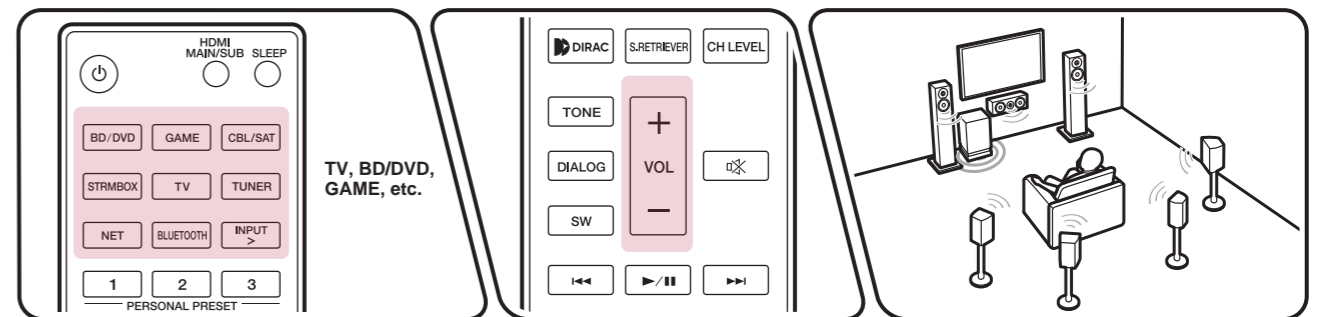

Troubleshooting

Dépannage / Solución de problemas

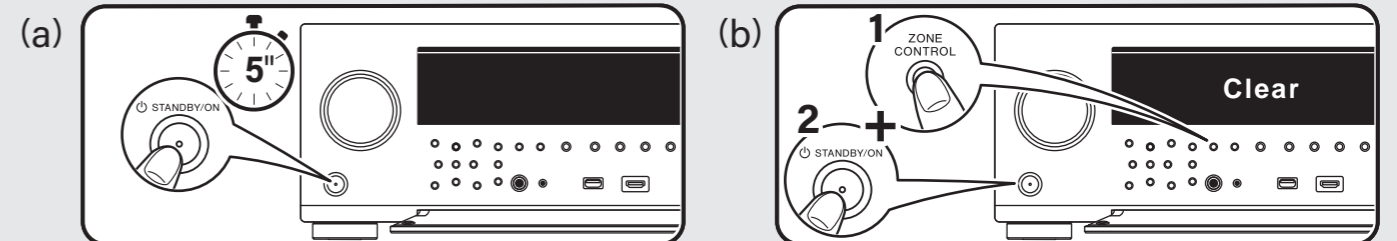

En Try restarting the unit. Switch this unit to standby, then do (a). If the problem is not fixed, try the following: Unplugging the power cord and HDMI cables then replugging them in again / Initializing the settings (do (b) while this unit is ON) / Updating the firmware

Fr Essayez de redémarrer l'appareil. Passez l'appareil en veille, puis effectuez (a). Si le problème n'est pas résolu, essayez les choses suivantes : Débrancher le cordon d'alimentation et les câbles HDMI puis les rebrancher / Initialiser les réglages (effectuer (b) pendant que cet appareil est sur ON) / Mettre à jour le micrologiciel

Es Pruebe a reiniciar la unidad. Ponga esta unidad en espera y luego haga (a). Si el problema no se soluciona, intente lo siguiente: Desenchufar el cable de alimentación y los cables HDMI y luego volver a enchufarlos / nicializar los ajustes (haga (b) mientras esta unidad está ON) / Actualizar el firmware

Voice Control Guide

<https://jp.pioneer-audiovisual.com/manual/playback/vcg.pdf>



ChromeCast Built-in

<https://jp.pioneer-audiovisual.com/manual/playback/chromecast.pdf>

